

MOBIMUNDO

2024



MOBIMUNDO siguiendo la estela de

PENA
VARGAS
DESDE 1931

Presentación



**“La casa debe ser el estuche de la vida,
la máquina de la felicidad”**

(Le Corbusier)

Al abrir la puerta de nuestro catálogo MOBIMUNDO entrará en un mundo de ideas para su hogar. Es este el motivo por el cual les invitamos a descubrir todas nuestras colecciones producto de una minuciosa selección de espacios singulares.

En nuestro recorrido de la mano de PEÑA VARGAS, nuestra empresa familiar, hemos venido atesorando una red comercial que nos enorgullece y mantiene vivo nuestro espíritu para seguir ofreciendo a nuestros estimados clientes lo mejor de nuestra labor.

**“The home should be the treasure chest of life,
the happiness machine.”**

(Le Corbusier)

Opening the door of our MOBIMUNDO catalogue will transport you to a world of ideas for your home. This is why we are inviting you to discover all our collections, resulting from a thorough selection of unique spaces.

During our time with PEÑA VARGAS, our family-run company, we have built up a business network to be proud of and which reflects our spirit, so we can continue to offer our esteemed customers the best of our work.

**“La casa dev’essere la custodia della vita,
la macchina della felicità”**

(Le Corbusier)

Sfogliando il nostro catalogo MOBIMUNDO entrerete in un mondo di idee per la vostra casa. Per questo motivo, vi invitiamo a scoprire tutte le nostre collezioni, frutto di una minuziosa selezione di spazi singolari.

Nel nostro viaggio insieme a PEÑA VARGAS, la nostra azienda di famiglia, abbiamo fatto tesoro di una rete commerciale di cui siamo orgogliosi e che mantiene vivo il nostro spirito, per continuare a offrire ai nostri stimati clienti tutto il meglio del nostro lavoro.

**“La maison doit être l’écrit de la vie,
la machine du bonheur”**

(Le Corbusier)

En ouvrant notre catalogue MOBIMUNDO, vous accédez à un monde d’idées pour votre maison. C’est pourquoi nous vous invitons à découvrir toutes nos collections, qui sont le résultat d’une sélection minutieuse d’espaces uniques.

Au fil des années, avec PEÑA VARGAS, notre entreprise familiale, nous avons tissé un réseau commercial qui nous rend fiers et nous permet de continuer à offrir à nos chers clients le meilleur de notre travail.

1. Colección RIGA
Pág. 6



2. Colección LOKI
Pág. 26



3. Colección VANIR
Pág. 36



4. Colección BARI
Pág. 46



5. Colección MARSELLA
Pág. 60



6. Colección OLIMPIA
Pág. 74



7. Colección ONTARIO
Pág. 82



8. Colección DIVERSA
Pág. 88



9. Colección ARTE EN CRISTAL
Pág. 100



10. Colección ARTE EN LIENZO
Pág. 122



11. Colección ESPEJOS
Pág. 136



12. Colección MESAS DE CRISTAL
Pág. 154



13. Colección HACHE
Pág. 166



14. Colección BELLA
Pág. 174



15. Colección CLÁSICOS DEL DISEÑO
Pág. 204



16. Colección SILLAS
Pág. 214



17. Colección MESAS
Pág. 232

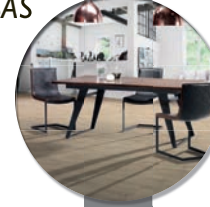

18. Colección LÁMPARAS
Pág. 254



Características

Muebles de estilo nórdico en chapa de nogal, las patas de los muebles y de algunas bases de mesas en acero laminado en frío y pintadas.

Las patas de sillas, butacas y mesas en ruber-wood y los asientos en tela de tapicería.

Characteristics

Nordic-style furniture with walnut veneers, with the legs of the furniture and some table bases in cold laminated steel and painted.

The legs of chairs, armchairs and tables in rubber-wood and the seats in upholstery fabric.

Lineamenti

Mobili in stile nordico impiallacciati in noce, gambe dei mobili e alcune basi per tavoli in acciaio laminato a freddo e verniciate.

Gambe di sedie, poltrone e tavoli in rubberwood e sedute in tessuto da tappezzeria.

Caracteristiques

Meubles de style nordique avec placage de bois de noyer, les pattes des meubles et de certaines bases de tables sont en acier laminé à froid et peintes.

Les pattes des chaises, des fauteuils et des tables sont en rubber-wood et les sièges sont fabriqués avec du tissu d'ameublement.



I COLECCIÓN RÌGA

THE MAN IN THE ARENA

"It is not the critic who counts; not the man who points out how the strong man stumbles, or where the doer of deeds could have done them better. The credit belongs to the man who is actually in the arena, whose face is marred by dust and sweat and blood; who strives valiantly; who errs, who comes short again and again, because there is no effort without error and shortcoming; but who does actually strive to do the deeds; who knows great enthusiasms, the great devotions; who spends himself in a worthy cause; who at the best knows in the end the triumph of high achievement, and who at the worst, if he fails, at least fails while daring greatly, so that his place shall never be filled by the cold and timid souls who would prefer to safety than nor defeat."



Mueble TV RIGA 200

200*40*51 cm.

Chapa de nogal/gris antracita

**Mesa rincón
redonda RIGA**
Ø42*45 cm
Tapa chapa nogal
Estructura metálica negra.



Sillón RIGA
83,5*58,5*68,5 cm.
Altura asiento: 38 cm.
Altura brazo: 64 cm.
Color nogal
TAP. 37

Mesa centro redonda RIGA
Ø80*38 cm
Tapa chapa nogal/Estructura
metálica negra

También disponible en:
Ø90*38 cm



Sillón RIGA

83,5*58,5*68,5 cm.
Altura asiento: 38 cm.
Altura brazo: 64 cm.
Color nogal
Tap.15.

Mesa rincón redonda RIGA

Ø42*45 cm
Tapa chapa nogal
Estructura metálica negra.

Vitrina RIGA 80

80*44,5*170 cm.
Chapa de nogal/gris antracita

PARIS
NEW YORK
MILANO
LONDON
TOKYO
CHICAGO



GRUPO
INTERMOBEL

Mesa centro redonda RIGA

Ø80*38 cm
Tapa chapa nogal/Estructura
metálica negra

También disponible en:
Ø90*38 cm

Mueble TV RIGA I70
170*40*51 cm.
Chapa de nogal/gris antracita



Mueble TV RIGA 170

170*40*51 cm.
Chapa de nogal/
gris antracita

Mesa de té RIGA

Ø64*47,5 /
Ø49*42,5 cm.
Chapa de nogal/
gris antracita

Sillón RIGA

83,5*58,5*68,5 cm.
Altura asiento: 38 cm.
Altura brazo: 64 cm.
Color nogal
TAP. 15

Mesa centro RIGA c/cajones

120*60*40 cm.
Chapa de nogal/
gris antracita



Mesa de Té RIGA

Ø64*47,5 / Ø49*42,5 cm.
Chapa de nogal/
gris antracita

**Mesa centro
triangular RIGA**

83*85*40 cm.
Chapa de nogal

**Mesa rincón
triangular RIGA**

49*48*46 cm.
Chapa de nogal



Vitrina RIGA 120
120*44,5*140 cm.
Chapa de nogal/gris
antracita

**Mesa rincón
triangular RIGA**
49*48*46 cm.
Chapa de nogal

**Mesa centro
triangular RIGA**
83*85*40 cm.
Chapa de nogal

Sillón RIGA
83,5*58,5*68,5 cm.
Altura asiento: 38 cm.
Altura brazo: 64 cm.
Color nogal
TAP. 15



Silla ASPEN
50,5*58*72,5 cm.
Color nogal
Tapizado 37
Altura asiento: 45 cm.



Silla ASPEN
50,5*58*72,5 cm.
Color nogal
Tapizado 15
Altura asiento: 45 cm.



**Aparador
RIGA 150**
150*44*85 cm.
Chapa de nogal/
gris antracita

Mesa RIGA Ø 137
Ø137*75 cm.
Tapa chapa de nogal/ Estructura
metálica negra

Silla RIGA
50*53,5*79,5 cm.
Altura asiento: 47 cm.
Color nogal
TAP. 15



Mesa comedor
redonda ext. **RIGA**
120/165*75 cm.
Color nogal



**Aparador alto
RIGA 180**
180*44*95 cm.
Chapa de nogal/gris
antracita

Silla JACOB
50,5*58,5*76,7 cm.
Color nogal
Tapizado 15
Altura asiento: 47 cm.



Aparador RIGA 150
150*44*85 cm.
Chapa de nogal/gris antracita



Mesa comedor extensible RIGA 150/200

150/200*90*75 cm.
Chapa de nogal

Silla RIGA

50*53,5*79,5 cm.
Altura asiento: 47 cm.
Color nogal
TAP. 15



Vitrina RIGA 120

120*44,5*140 cm.
Chapa de nogal/
gris antracita

Mesa comedor RIGA 200

200*90*75 cm.
Chapa de nogal

Silla RIGA

50*53,5*79,5 cm.
Altura asiento: 47 cm.
Color nogal
Tap. 37

También disponible: Mesa
comedor RIGA 160
160*90*75 cm.

**Mesa comedor
oval RIGA**

180*90*76 cm.
Estructura metálica/
tapa chapa de nogal

**Mueble "storage"
RIGA 130**

130*44*130 cm.
Chapa de nogal/gris
antracita y gris

Silla JACOB

50,5*58,5*76,7 cm.
Color nogal
Tapizado 37
Altura asiento: 47 cm.



**Mueble "storage"
RIGA 130**
130*44*130 cm.
Chapa de nogal/gris
antracita y gris



**Mesa comedor
RIGA 150**
150*90*75 cm.
Chapa de nogal

Silla RIGA
50*53,5*79,5 cm.
Altura asiento: 47 cm.
Color nogal
Tap. 37



**Consola
RIGA 100**
100*30*75 cm.
2 huecos
Chapa de nogal/gris
antracita



Estantería RIGA

159*42*173 cm.
Medida Estante: 150*37 cm.
Chapa de nogal/
gris antracita



Mesa Bar - RIGA

120*40*91,5 cm.
Chapa de nogal



Taburete RIGA

38,7*46,5*77 cm.
Altura asiento: 61,5 cm.
Colot nogal
Tap. 2

Características

Muebles de estilo nórdico en chapa de roble, algunas bases de mesas en acero laminado en frío y pintadas.

Las patas de muebles, sillas, butacas y mesas en ruber-wood y los asientos en tela de tapicería.

Characteristics

Nordic-style furniture with oak veneers, with the legs of the furniture and some table bases in cold laminated steel and painted.

The legs of chairs, armchairs and tables in rubber-wood and the seats in upholstery fabric.

Lineamenti

Mobili in stile nordico impiallacciati in rovere, gambe dei mobili e alcune basi per tavoli in acciaio laminato a freddo e verniciati.

Gambe di sedie, poltrone e tavoli in rubberwood e sedute in tessuto da tappezzeria.

Caracteristiques

Meubles de style nordique avec placage de bois de chêne, les pattes des meubles et de certaines bases de tables sont en acier laminé à froid et peintes.

Les pattes des chaises, des fauteuils et des tables sont en rubber-wood et les sièges sont fabriqués avec du tissu d'ameublement.

GRUPPO
m u e b l e s
INTERMOBEL



2 COLECCIÓN LOKI



Estantería LOKI

159*42*173 cm.
Medida Estante:
150*37 cm.
Chapa de roble/gris
antracita

Silla LOKI

53*59*84 cm.
Altura asiento: 47 cm.
Color roble
TAP. IS

Mesa LOKI Ø 137

Ø137*75 cm.
Chapa de roble/Estructura
metálica negra



Mesa comedor extensible LOKI 150/200
150/200*90*75 cm.
Chapa de roble.

Silla LOKI
53*59*84 cm.
Altura asiento: 47 cm.
Color roble
TAP. 37

Aparador LOKI 150
150*44*85 cm.
Chapa de roble/gris antracita



Mesa rincón bicolor LOKI

60*60*48
Chapa de roble/gris antracita



Sillón LOKI

59*66,5*69 cm.
Altura asiento: 36 cm.
Altura brazo: 50 cm.
Color roble
TAP. 37



Reposapiés LOKI

34*44*35 cm.
Color roble
TAP. 37

GRUPO muebles
INTERMOBEL



Mesa de Té LOKI

Ø64*47,5 / Ø49*42,5 cm.
Chapa de roble/gris antracita



Mesa rincón bicolor LOKI

60*60*48
Chapa de roble/
gris antracita

Sillón LOKI

59*66,5*69 cm.
Altura asiento: 36 cm.
Altura brazo: 50 cm.
Color roble
TAP. 15

Consola LOKI 120

120*40*75 cm.

Chapa de roble/gris antracita

Mesa de Té LOKI

Ø64*47,5 / Ø49*42,5 cm.

Chapa de roble/gris antracita



Mueble TV LOKI 170

170*40*50,5 cm.

Chapa de roble/gris antracita

Mesa centro bicolor LOKI

120*60*40 cm.

Chapa de roble/gris antracita

Vitrina LOKI 90

90*44,5*180 cm.
Chapa de roble/gris antracita

Mesa rincón redonda LOKI

Ø42*45 cm.
Chapa de roble/Estructura metálica negra



Mueble TV LOKI 170

170*40*50,5 cm.
Chapa de roble/gris antracita

Mesa centro redonda LOKI

Ø80*38 cm.
Chapa de roble/Estructura metálica negra
También disponible en Ø90*38 cm.

Sillón LOKI

59*66,5*69 cm.
Altura asiento: 36 cm.
Altura brazo: 50 cm.
Color roble
TAP. 37



Mesa comedor LOKI 150
150*90*75 cm.
Chapa de roble

Silla LOKI
53*59*84 cm.
Altura asiento: 47 cm.
Color roble
TAP. 37



Mesa bar LOKI
Ø80*91,5 cm.
Chapa de roble

Taburete LOKI
47,5*40,5*61,5cm.
Color roble
Tap. 2



Vitrina LOKI 90

90*44,5*180 cm.
Chapa de roble/
gris antracita

**Mesa rincón
cuadrada LOKI**

60*60*45 cm.
Chapa de roble

Sillón LOKI

59*66,5*69 cm.
Altura asiento: 36 cm.
Altura brazo: 50 cm.
Color roble
TAP. 15

Reposapiés LOKI

34*44*35 cm.
Color roble
Tap. 15

Mesa centro rectangular LOKI

120*60*40 cm.
Chapa de roble

Características

Colección de muebles en kit, de estilo nórdico funcional y líneas sencillas, realizados en MDF y chapa de nogal tintado con estructuras metálicas.

Characteristics

A collection of self-assembly furniture in a functional Nordic style with simple lines, made of MDF and stained walnut veneers with metal structures.

Lineamenti

Una collezione di kit di mobili, dallo stile nordico funzionale e dalle linee semplici, realizzati in MDF e impiallacciatura di noce tinto con strutture metalliche.

Caracteristiques

Collection de meubles en kit, de style nordique fonctionnel et aux lignes simples, fabriqués en MDF et en placage de noyer teinté avec des structures métalliques.

muebles
GRUPO **INTERMOBEL**



3
COLECCIÓN
VANIR

Mueble TV VANIR

152*40*55 cm.
Chapa nogal/gris
(Mueble en kit)

Buffet VANIR

100*40*139 cm.
Chapa nogal/gris
(Mueble en kit)



Mesa centro VANIR 120

120*60*45 cm.
Chapa nogal/estructura
metálica negra
(Mueble en kit)

Lámpara de ple 732
65*50 170/200 cm.

Mesa rincón VANIR 50

50*50*45 cm.
Chapa nogal/estructura
metálica negra
(Mueble en kit)

Mesa rincón VANIR 40

40*40*40cm.
Chapa de nogal/estructura
metálica negra
(Mueble en kit)

**Aparador
VANIR 100**
100*40*90 cm.
Chapa nogal/gris
(Mueble en kit)

Mesa centro VANIR 110

110*50*40 cm.
Chapa nogal/estructura
metálica negra
(Mueble en kit)

Silla rattan c/cojín 9988

60*64*90 cm.
Altura asiento: 45 cm.
Altura brazos: 68 cm.



Mueble TVVANIR

152*40*55 cm.
Chapa nogal/gris
(Mueble en kit)

Mesa centro VANIR

(Mueble en kit)
110*50*40 cm.
120*60*45 cm.

Mesa rincón VANIR 50

Chapa nogal/estructura
metálica negra
(Mueble en kit)
50*50*45 cm.



GRUPO **muebles**
INTERMOBEL

Mesa rincón VANIR 40

Chapa nogal/estructura
metálica negra
(Mueble en kit)
40*40*40 cm.



Mesa comedor VANIR-R

160*85*75 cm.
(Mueble en kit)
Chapa nogal/estructura
metálica negra

Silla BAYONA

55*61*87 cm.
Altura asiento: 47 cm.

Disponibles en
Tap. 1 Beige (2 tonos)
Tap. 2 Gris (2 tonos)

**Aparador
VANIR 100**

100*40*90 cm.
Chapa nogal/gris
(Mueble en kit)

**Mesa centro
VANIR 110**

110*50*40 cm.
Chapa nogal/estructura
metálica negra
(Mueble en kit)

**Mesa centro
VANIR 120**

120*60*45 cm.
Chapa nogal/estructura
metálica negra
(Mueble en kit)



**Aparador
VANIR 142**

142 *42*90 cm.
Chapa nogal/gris
(Mueble en kit)

Silla NANTES

55*61*88 cm.
Altura asiento: 45 cm.
Disponibles en
Tap. 1 Beige (2 tonos)
Tap. 2 Gris (2 tonos)



Mesa comedor VANIR-V

160*85*75 cm.
Chapa nogal/estructura
metálica negra
(Mueble en kit)

Buffet VANIR

100*40*139 cm.
Chapa nogal/gris
(Mueble en kit)



Lámpara de techo
910-D

42*42*60 cm.

Aparador VANIR 142

142*42*90 cm.
Chapa nogal/gris
(Mueble en kit)

Aparador VANIR 100

100*40*90 cm.
Chapa nogal/gris
(Mueble en kit)

Silla BORGONA

Tap. 1 Camel (2 tonos)
Tap. 2 Gris (1 tono)
47.5*55*82cm.
Altura asiento: 48cm.

Mesa comedor VANIR-R

160*85*75 cm.
Chapa nogal/estructura
metálica negra
(Mueble en kit)

Buffet VANIR

100*40*139 cm.
Chapa nogal/gris
(Mueble en kit)

Sofá B-810 - 2 plazas

Piel blanca
145*70*70 cm.
Altura asiento:
44,5 cm.

Mesa rincón VANIR 50

50*50*45 cm.
Chapa nogal/estructura metálica negra
(Mueble en kit)

Mesa rincón VANIR 40

40*40*40 cm.
Chapa nogal/estructura metálica negra
(Mueble en kit)

Mesa centro VANIR 110

110*50*40 cm.
Chapa nogal/estructura metálica negra
(Mueble en kit)

Mesa centro VANIR 120

120*60*45 cm.
Chapa nogal/estructura metálica negra
(Mueble en kit)

Mueble TV VANIR

152*40*55 cm.
Chapa nogal/gris
(Mueble en kit)



Características

Muebles contemporáneos de marcadas líneas rectas con molduras y puertas de cristal para dar ligereza a cada pieza de la colección. Fabricados en madera de Mahoni y MDF y lacados en blanco.

Characteristics

Modern furniture with clean-cut edging and carved framework. The clear glass doors give an illusion of lightness to each piece in the collection. Made of Mahoni wood, MDF and finished in a white lacquer.

Lineamenti

Mobili contemporanei con marcate linee rette, con modanature e porte in vetro per dare leggerezza ad ogni pezzo della collezione. Realizzati in Mohani e MDF e laccati bianco.

Caracteristiques

Meubles contemporains aux lignes droites marquées avec moulures et portes en verre de façon à apporter de la légèreté à chaque article de la collection. Fabriqués en bois de Mahoni et MDF laqué blanc.

GRUPPO
m u e b i l e s
INTERMOBEL



4
COLECCIÓN
BARI



Foto sobre cristal 005
120 x 80 cm.

Aparador BARI 183
Puertas de cristal
Color blanco
183 x 51 x 91 cm.

Mesa comedor BARI
extensible Butterfly
160/220 x 95 x 78 cm.



Silla BARI rejilla

Color blanco
48 x 57 x 105 cm.
Altura asiento: 52 cm.



Vitrina BARI 120 baja

Cuatro cajones
Color blanco
120 x 48 x 140 cm.

Librería BARI 69

Color blanco
69 x 40 x 186 cm.

Mueble TV BARI 1

Color blanco
170 x 51 x 56 cm.

Mesa rincón BARI 60

Tapa de cristal

Color blanco
60 x 60 x 55 cm.

Vitrina BARI 83
Color blanco
83 x 47 x 210 cm.



Mesa centro BARI 132
Tapa de cristal
Color blanco
132 x 76 x 46 cm.

GRUPO **INTERMOBEL**



Vitrina BARI 120 baja

4 cajones

Color blanco

120 x 48 x 140 cm.

GRUPO m u e b l e s
INTERMOBEL



Aparador BARI 134

Color blanco

134 x 50 x 94 cm.



Aparador BARI 183
Puertas de cristal

Color blanco
183 x 51 x 91 cm.



Aparador BARI 183
Puertas de madera

Color blanco
183 x 51 x 91 cm.



Vitrina BARI 120 Alta
2 Cajones
2 Cuerpos.
Color blanco
120 x 50 x 210 cm.

Vitrina BARI
2 Puertas de cristal
Color blanco
120 x 53 x 215 cm.





Vitrina BARI 83

Color blanco
83 x 47 x 210 cm.



Vitrina BARI 69

Color blanco
69 x 40 x 186 cm.



Libreria BARI 69

Color blanco
69 x 40 x 186 cm.

GRUPO muebles
INTERMOBEL

Mesa centro BARI 132
Tapa de cristal
Color blanco
132 x 76 x 46 cm.



Mesa rincón BARI 60
Tapa de cristal
Color blanco
60 x 60 x 55 cm.



Mesa centro BARI
Elevable 120
Tapa de madera
Color blanco
122 x 70 x 50 cm.



GRUPO **INTERMOBEL**
muebles



Mesa centro fija BARI 120
Tapa de madera
Color blanco
122 x 70 x 50 cm.



CERRADA

Mesa comedor BARI
Extensible BUTTERFLY
Color blanco
160/220 x 95 x 78 cm.



ABIERTA



Silla BARI ASPA
Color blanco
48 x 57 x 105 cm.
Altura asiento: 52 cm.



Silla BARI REJILLA
Color blanco
48 x 57 x 105 cm.
Altura asiento: 52 cm.



Mueble TV BARI 170

Color blanco
170 x 51 x 56 cm.



Mueble TV BARI 120

Color blanco
120 x 50 x 60 cm.

Características

Muebles de un marcado estilo francés, combinando la madera lacada de Mahoni en blanco con suave pátina y tapas chapadas realzando las molduras.

Characteristics

French style furniture in designs that combine white, lacquered Mahoni wood with a subtle patina and veneer finish enhancing the carved framework.

Lineamenti

Mobili in spiccato stile francese, che unisce il legno di Mohani laccato bianco con una leggera patina e piani placcati esaltando le modanature.

Caracteristiques

Meubles de style typiquement français, associant bois de Mahoni laqué blanc avec une patine douce ainsi qu'un placage qui met en valeur les moulures.



5
COLECCIÓN
MARSELLA

Espejo H709

Plata veneciana
90 x 120 x 10 cm.

MUEBLES
GRUPO **INTERMOBEL**

Aparador 150 MARSELLA

Color blanco con pátina
150 x 50 x 90 cm.

Silla WILSON RATTAN

Color blanco marsella
46 x 42 x 87 cm.
Altura asiento: 46 cm.



Mesa Butterfly MARSELLA

Color blanco con pátina
160/220 x 96 x 76 cm



Vitrina 100 MARSELLA
2 cuerpos
Color blanco con pátina.
100 x 50 x 215 cm.



Silla MARSELLA
Color blanco con pátina.
50 x 45 x 99 cm.
Altura asiento: 49 cm.

Aparador 192 MARSELLA

2 Cajones / 3 puertas
Color blanco con pátina
192 X 50 x 1 00 cm



**Mesa extensible
MARSELLA**

Color blanco con pátina.
160/240 x 96 x 7 6 cm.

Sillón MARSELLA

Color blanco con pátina.
56 x 4 9 x 99 cm.
Altura asiento: 49 cm.
Altura brazos: 66,5 cm.

Aparador 150 MARSELLA

Color blanco con pátina.
150 x 50 x 90 cm.



Aparador 192 MARSELLA

2 Cajones / 3 puertas.
Color blanco con pátina.
192 x 50 x 100 cm

GRUPO
muebles
INTERMOBEL



Mueble TV MARSELLA

Color blanco con pátina
135 x 40 x 57 cm.



Mesa centro MARSELLA

Color blanco con pátina.
130 x 70 x 42 cm.



Mueble TV MARSELLA 135

Color blanco con pátina.
135 x 40 x 57 cm.



Mueble TV MARSELLA 170

Color blanco con pátina.
170 x 40 x 57 cm.



Mesa centro MARSELLA

Color blanco con pátina.
130 x 70 x 42 cm.



Mesa centro MARSELLA ELEVABLE

Color blanco con pátina.
130 x 70 x 42 cm.





**Aparador pequeño 80
MARSELLA**

2 cajones / 2 puertas
Color blanco con pátina.
80 x 40 x 82 cm.



Mesa rincón MARSELLA

Color blanco con pátina.
60 x 60 x 60 cm.



**Mesita té MARSELLA
con cajón**

Color blanco con pátina.
70 x 40 x 75 cm.



**Vitrina 100 MARSELLA
2 cuerpos**

Color blanco con pátina.
100 x 50 x 215 cm.

Vitrina 192 MARSELLA

2 cuerpos

Color blanco con pátina.

192 x 50 x 220 cm.



Vitrina 60 MARSELLA

Color blanco con pátina.
60 x 45 x 190 cm.



Vitrina 113 MARSELLA

Color blanco con pátina.
113 x 45 x 220 cm.



Silla WILSON RATTAN

Color blanco marsella.
46 x 42 x 87 cm.
Altura asiento: 46 cm.



Abierta

**Mesa cuadrada
Extensible MARSELLA**

Color blanco con pátina.
96/156 x 96 x 76 cm



Cerrada



Abierta

**Mesa Extensible
MARSELLA**

Color blanco con pátina.
160/240 x 96 x 76 cm.



Mesa fija MARSELLA
Color blanco con pátina.
160 x 96 x 76 cm.



Sillón MARSELLA
Color blanco con pátina.
56 x 49 x 99 cm.
Altura asiento: 49 cm.
Altura brazos: 66,5 cm.



Silla MARSELLA
Color blanco con pátina.
50 x 45 x 99 cm.
Altura asiento: 49 cm.



Abierta

Mesa Butterfly MARSELLA
Color blanco con pátina.
160/220 x 96 x 76 cm.

Características

Dormitorio romántico-colonial en madera de álamo lacado en blanco ceniza y combinado con molduras de fresno decapada.

Characteristics

A romantic and colonial-style bedroom. The collection features poplar wood furniture with a white lacquer finish and a stripped carved ash framework.

Lineamenti

Camera da letto romantica-coloniale in legno di pioppo laccato bianco e combinato con modanature di frassino decapato.

Caracteristiques

Chambre de styles romantique et colonial en bois de peuplier blanc laqué assortie de moulures en frêne décapé.



6
COLECCIÓN
OLÍMPIA

Cabecero OLIMPIA Recto

Color blanco ceniza.
157 x 120 cm.
Para colchón de 150 cm.

Mesilla OLIMPIA

Color blanco ceniza.
45 x 40 x 65 cm.

55 x 40 x 65 cm.

Cuadro 509

100*100 cm.

Marco plata



Cómoda OLIMPIA

Color blanco ceniza.
125 x 50 x 93 cm.

Banqueta OLIMPIA 2 Plazas

Color blanco ceniza.
100 x 35 x 46 cm.

Mesilla OLIMPIA

Color blanco ceniza.
45 x 40 x 65 cm.

55 x 40 x 65 cm.

Cabecero OLIMPIA Curvo

Color blanco ceniza.
156 x 119 cm.
Para colchón de 150 cm.



Tocador OLIMPIA

Color blanco ceniza.
130 x 50 x 79 cm.



Banqueta OLIMPIA I Plaza

Color blanco ceniza.
50 x 35 x 46 cm.



CERRADO

Tocador OLIMPIA

Color blanco ceniza.
130 x 50 x 79 cm



Mesilla OLIMPIA

Color blanco ceniza.
45 x 40 x 65 cm.

55 x 40 x 65 cm.



Cómoda OLIMPIA

Color blanco ceniza.
125 x 50 x 93 cm.

Cabecero OLIMPIA Recto

Color blanco ceniza
157*120 cm.
Para colchón de 150 cm.



muebles
CORSA
INTERMOBEL



Cabecero OLIMPIA Curvo

Color blanco ceniza
156*119 cm.
Para colchón de 150 cm.

**Banqueta OLIMPIA
1 Plaza**

Color blanco ceniza.
50 x 35 x 46 cm.



**Banqueta OLIMPIA
2 Plazas**

Color blanco ceniza.
100 x 35 x 46 cm.



Características

Dormitorio de estilo romántico en madera lacada de Mahoni y MDF con suave pátina y tapas chapadas.

Characteristics

A romantic bedroom suite with lacquered wooden furniture made of Mahoni and MDF with a subtle patina finish and veneer tops.

Lineamenti

Camera da letto in stile romantico in legno laccato di Mohani e MDF con una leggera patina e piani impiallacciati.

Caracteristiques

Chambre de style romantique en bois de Mahoni et MDF laqué avec une patine douce et un placage bois.

muebles
INTERMOBEL



7
COLECCIÓN
ONTARIO



Cómoda ONTARIO
Color blanco pátina.
120 x 50 x 98 cm.

Mesilla ONTARIO
Color Blanco Pátina.
45 x 40 x 75 cm.



Cabecero ONTARIO

Para colchón de 1,50 mts.
Color blanco pátina.
168 x 9,5 x 145 cm.



Banqueta ONTARIO

1 plaza

Color blanco pátina.
43 x 40 x 44 cm.



Tocador ONTARIO

Color blanco pátina.
135 x 48 x 75 cm.



Cabecero ONTARIO
Para colchón de 150 cm.
Color blanco pátina.
168 x 9,5 x 145 cm.

Cómoda ONTARIO
Color blanco pátina.
120 x 50 x 98 cm.



Mesilla ONTARIO
Color blanco pátina.
45 x 40 x 75 cm.



Chiffonnier ONTARIO

Color blanco pátina.
58 x 45 x 130 cm.



Tocador ONTARIO

Color blanco pátina.
135 x 48 x 75 cm.

GRUPO **muebles**
INTERMOBEL



Banqueta ONTARIO

1 Plaza

Color blanco pátina.
43 x 40 x 44 cm.



Banqueta ONTARIO 2 Plazas

Color blanco pátina.
130 x 40 x 44 cm.

Características

Miscelánea de muebles realizados en maderas macizas y maderas vistas, combinadas con lacados suavemente patinados, el roble, el olmo y el mahoni son las maderas estrellas de esta colección.

Characteristics

Assortment of furniture made from solid, exposed woods combined with smooth varnishes. Oak, elm and mahoni are the star woods in this collection.

Lineamenti

Un mix di mobili realizzati in legno massiccio e legni a vista, abbinati a laccature leggermente patinate, mentre legni come il rovere, l'olmo o il mahoni sono i protagonisti di questa collezione.

Caracteristiques

Des meubles de toutes sortes en bois massif et en bois apparent, combinés à des laques à la patine douce. Le chêne, l'orme et le mahoni sont les bois vedettes de cette collection.

GRUPPO
m u e b l e s
INTERMOBEL



8
COLECCIÓN
DIVERSA
ÚLTIMAS UNIDADES



Aparador 3 puertas MOMBASA
Roble anticuario
202 x 55 x 90 cm



Vitrina MOMBASA
2 cuerpos
Roble anticuario
149 x 48 x 215 cm



Biblioteca SIDNEY
2 cuerpos con escalera
122 x 45 x 230 cm

Mueble TV NIZA
150 x 48 x 50 cm



muebles
INTERMOBEL

Mueble TV SIDNEY
160 x 50 x 60 cm





Estantería FIORDO 70
70*20*17 cm.
Teca maciza



Estantería FIORDO 140
140*20*17 cm.
Teca maciza



Mueble tv FIORDO 200
200*45*59 cm.
Teca maciza



Mueble tv FIORDO 150
150*45*59 cm.
Teca maciza





Vitrina OSLO 120
Chapa color Roble
120*40*120 cm.

Aparador TRENTO 185
185 x 50 x 90 cm.



GRUPO m u e b l e s
INTERMOBEL



Mueble TV TRENTO
150 x 45 x 56 cm.



Vitrina TRENTO 112
112 x 45 x 210 cm.

Alacena AMBIENTES
2 cuerpos
Color vainilla.
72 x 44 x 192 cm.





**Mueble TV
AMBIENTES 135**
Color vainilla.
135 x 40 x 60 cm.



Alacena / bar BONANZA
Color blanco patinado
Madera vista de olmo reciclado
85 x 40 x 106 cm



**Botellero
AMBIENTES**
36 x 39 x 120 cm.

Características

Sorprendentes fotografías impresas directamente en cristal, con sus medidas de gran tamaño consiguen aportar la decoración precisa en cualquier pared del hogar.

Characteristics

Striking large-size photographs printed directly onto glass contribute the decoration you require for any wall of your home.

Lineamenti

Fotografie incredibili stampate direttamente sul vetro che, grazie alle loro grandi dimensioni, riescono a conferire una decorazione specifica a qualsiasi parete della casa.

Caracteristiques

Des photographies surprenantes imprimées directement sur du verre, dont la grande taille permet de décorer avec précision n'importe quel mur de la maison.



9
COLECCIÓN
ARTE EN CRISTAL



Foto cristal 003

120 x 120 cm. 15,9 kg.

80*80 cm. 7,9 kg.



Foto cristal 002

80*80 cm. 7,9 kg.

120 x 120 cm. 15,9 kg.

Foto cristal 029

120 x 120 cm. 15,9 kg.

80*80 cm. 7,9 kg.



Foto cristal 032

80*80 cm. 7,9 kg.

120 x 120 cm. 15,9 kg.



Foto cristal 021
150 x 100 cm. 16,5 kg.



Foto cristal 006
120 x 80 cm. 11,1 kg.
180 x 120 cm. 23,1 kg.



Foto cristal 009
120 x 80 cm. 11,1 kg.



Foto cristal 004
180 x 120 cm. 23,1 kg.
120 x 80 cm. 11,1 kg.



Foto cristal 036
120 x 80 cm. 11,1 kg.



Foto cristal 024
120 x 80 cm. 11,1 kg.
180 x 120 cm. 23,1 kg.



Foto cristal 007

180 x 120 cm. 23,1 kg.

120 x 80 cm. 11,1 kg.



Foto cristal 010

120 x 80 cm. 11,1 kg.



Foto cristal 005

120 x 80 cm. 11,1 kg.



Foto cristal 018
180 x 120 cm. 23,1 kg.
120 x 80 cm. 11,1 kg.



Foto cristal 017
120 x 80 cm. 11,1 kg.
180 x 120 cm. 23,1 kg.



Foto cristal 012
120 x 80 cm. 11,1 kg.
180 x 120 cm. 23,1 kg.



Foto cristal 063T
 Tríptico (60*120 cm.*3)

GRUPO
 MUEBLES
INTERMOBEL



Foto cristal 057
 120*80 cm.



Foto cristal 063
 120*80 cm.



Foto cristal 055
120*80 cm.
180*120 cm.



Foto cristal 054
150*100 cm.



Foto cristal 022

180 x 120 cm. 23,1 kg.

120 x 80 cm. 11,1 kg.



Foto cristal 023

160 x 60 cm.
11,1 kg.



Foto cristal 037

180 x 70 cm.
14,10 kg.



Foto cristal 036T

Triptico: 60*120 cm. (3)
Medida total 180x120 cm. 23,1 kg.

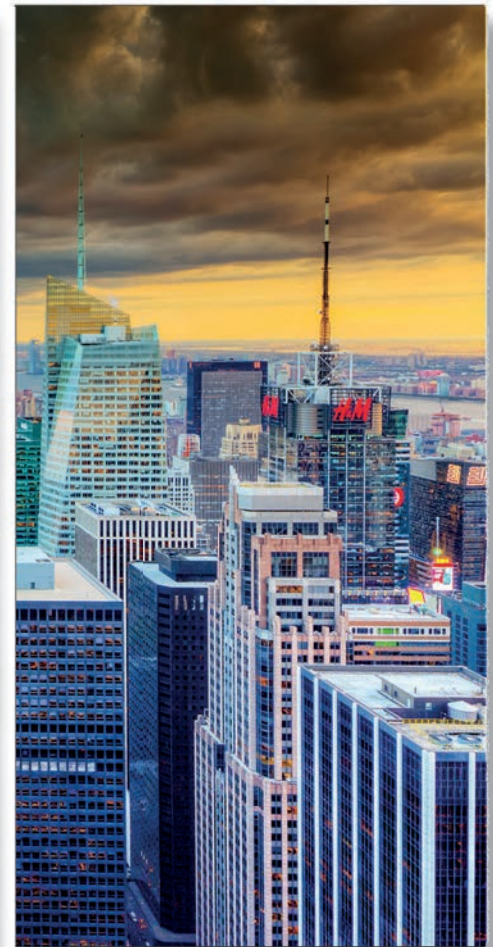

GRUPPO **INTERMOBEL**

Foto cristal 059
180*120 cm.



Foto cristal 060
180*90 cm.



Foto cristal 030

160 x 60 cm.
11,1 kg.



Foto cristal 056
80*120 cm.



Foto cristal 025

150 x 100 cm.
16,5 kg.

GRUP
muebles
INTERMOBEL



Foto cristal 042

150 x 100 cm. 16,5 kg.

Foto cristal 040T

Triptico:
60*120 cm. (3)
Medida total:
180x120 cm. 23,1 kg.



Foto cristal 040
120 x 80 cm. 11,1 kg.

Foto cristal 039
100 x 150 cm. 16,5 kg.



Mesa 20399-48
Acabado latón anticuario
Ø46*48 cm.

Sillón giratorio
y reposapiés T044
Piel marrón
Sillón 83 x 82 x 84,5 cm.
Altura asiento: 40 cm.
Altura brazo: 50 cm.

Reposapiés 64 x 54 x 44 cm.



Foto cristal 014

150 x 100 cm.
16,5 kg.



muebles
GRUPO INTERMOBEL

Foto cristal 015

150 x 100 cm. 16,5 kg.



Foto cristal 011

150 x 100 cm. 16,5 kg.



Foto cristal 001
150 x 100 cm. 16,5 kg.



Foto cristal 050
120*80 cm.
180*120 cm.



Foto cristal 047
120*80 cm.

muebles
INTERMOBEL

Foto cristal 061
80*120 cm.



Foto cristal 062
150*100 cm.



Foto cristal 043
150*100 cm.

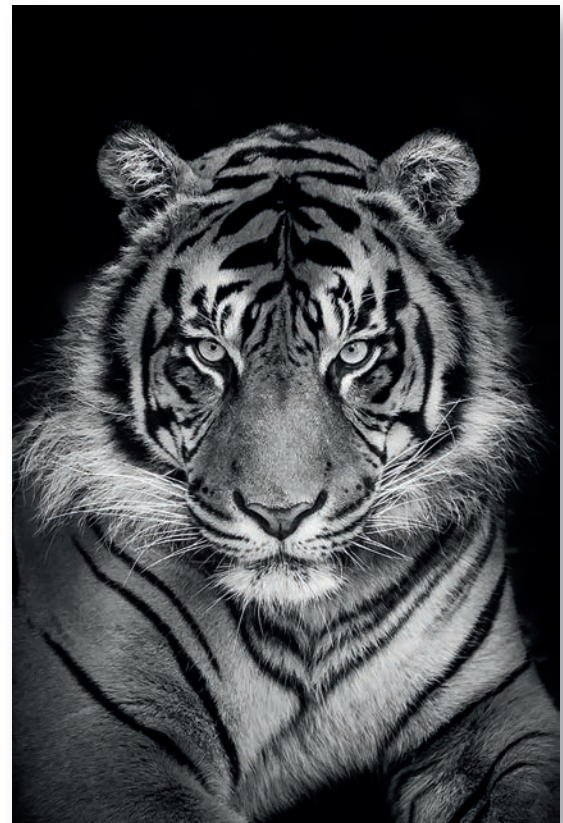

Foto cristal 044
120*80 cm.

GRUPO m u e d i e s
INTERMOBEL

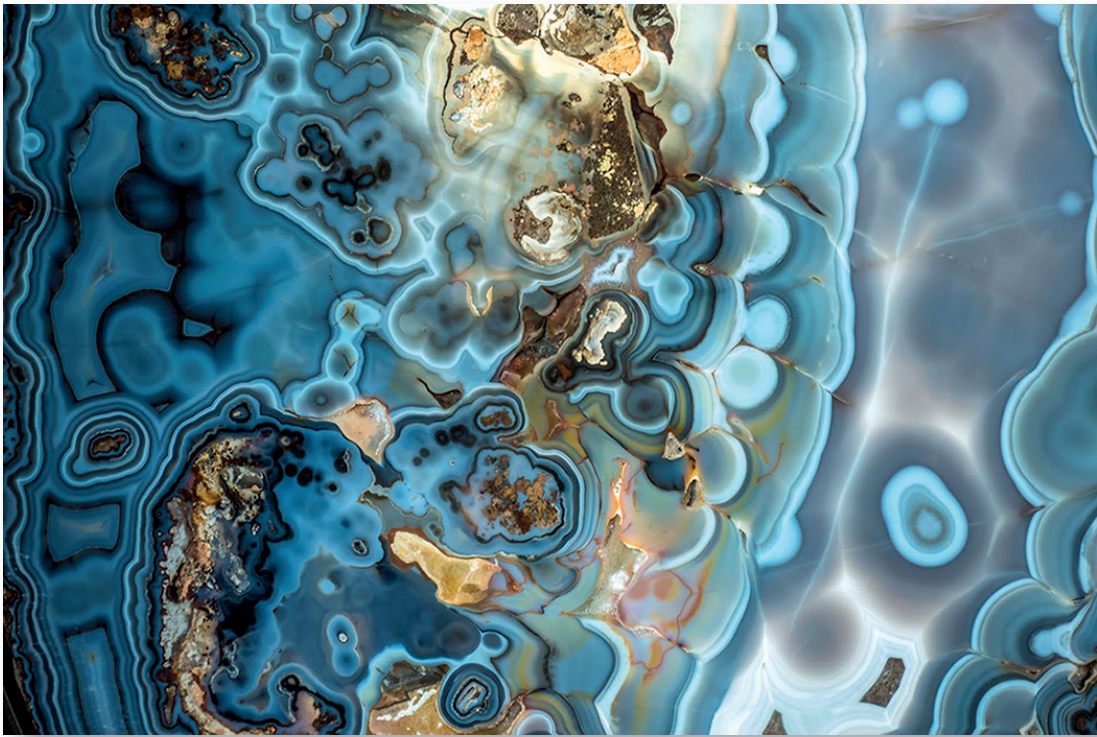

Foto cristal 048
120*80 cm.



Foto cristal 034

80 x 120 cm.
11,1 kg.



muebles
INTERMOBEL



Foto cristal 033

120 x 80 cm. 11,1 kg.

Características

Cuadros realizados con pintura acrílica sobre lienzo. Los cuadros enmarcados tienen molduras de PS (poliestireno). Algunos modelos están pintados a mano al cien por cien, en cuyo caso se especifica. Otros modelos están acabados a mano al menos en un 50% sobre impresión.

Characteristics

Paintings made with acrylic paint on canvas. Framed paintings have PS (polystyrene) moldings. Some models are 100% hand painted, in which case it is specified. Other models are at least 50% hand-finished on print.

Lineamenti

Dipinti realizzati con colori acrilici su tela. I quadri incorniciati hanno modanature in PS (polistirolo). Alcuni modelli sono dipinti a mano al 100%, nel qual caso è specificato. Altri modelli sono rifiniti a mano per almeno il 50% sulla stampa.

Caractéristiques

Peintures réalisées avec de la peinture acrylique sur toile. Les tableaux encadrés ont des moulures en PS (polystyrène). Certains modèles sont peints à 100 % à la main, auquel cas cela est précisé. D'autres modèles sont finis à la main à au moins 50 % sur l'impression.

m u e b l e s
INTERMOBEL



10
COLECCIÓN
ARTE EN LIENZO



Cuadro 510
120*120 cm.

Marco plata



Cuadro 509
100*100 cm.

Marco plata



Cuadro 502
100*100 cm.

Marco negro



Cuadro 531
120*150 cm.

Marco plata

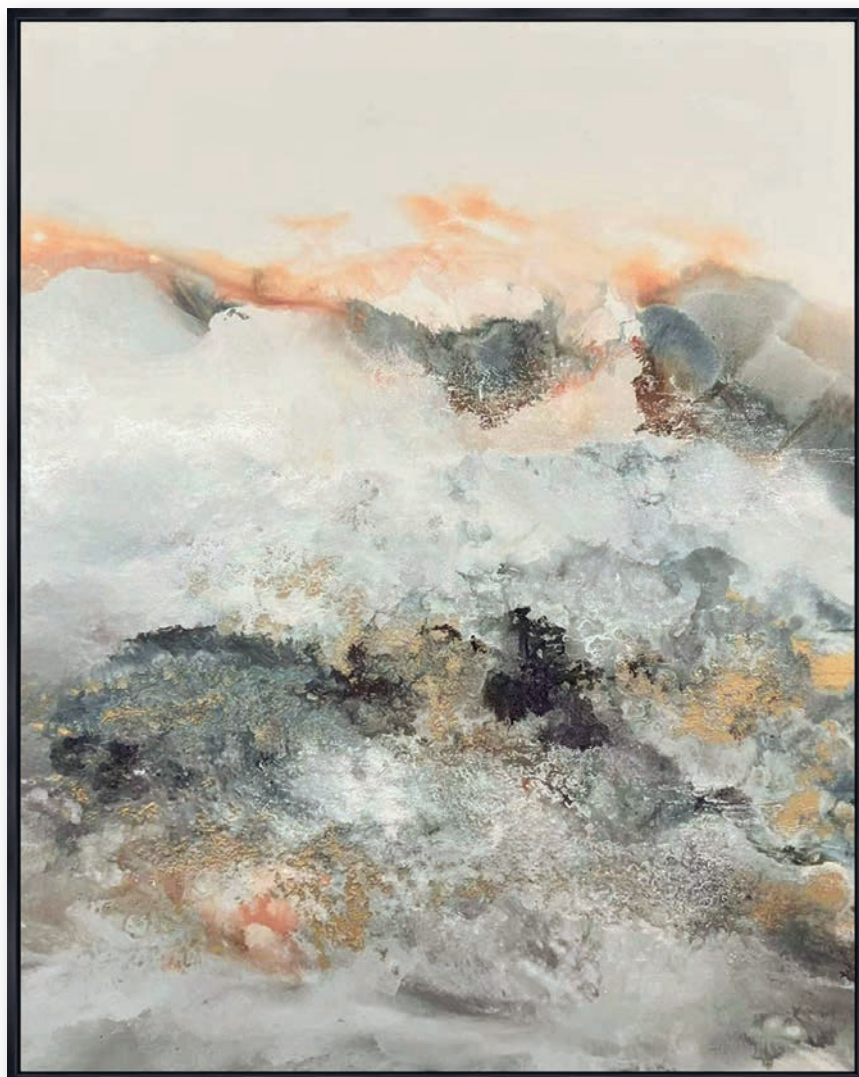

Cuadro 517
120*150 cm.

Marco negro



Cuadro 530
90*180 cm.

Marco negro



GRUPO muebles
INTERMOBEL

Cuadro 513
120*180 cm.

Marco blanco



Cuadro 514
120*120 cm.

Marco negro



Cuadro 524
90*120 cm.

Marco blanco



Cuadro 522
120*150 cm.

Marco plata



Cuadro 521
100*100 cm.

Marco dorado



Cuadro 525D
 Díptico: 90*120 cm. (2)
 Marcos plata

GRUPO **INTERMOBEL**



Cuadro 526D Díptico:
 100*100 cm. (2)
 Lienzos sin enmarcar

Pintado a mano



Cuadro 528D Díptico:
100*100 cm. (2)
Marcos negros



Cuadro 527
120*90 cm.
Marco plata



Cuadro 505
150*100 cm.

Marco dorado

Pintado a mano



Cuadro 503
180*70 cm.

Marco blanco

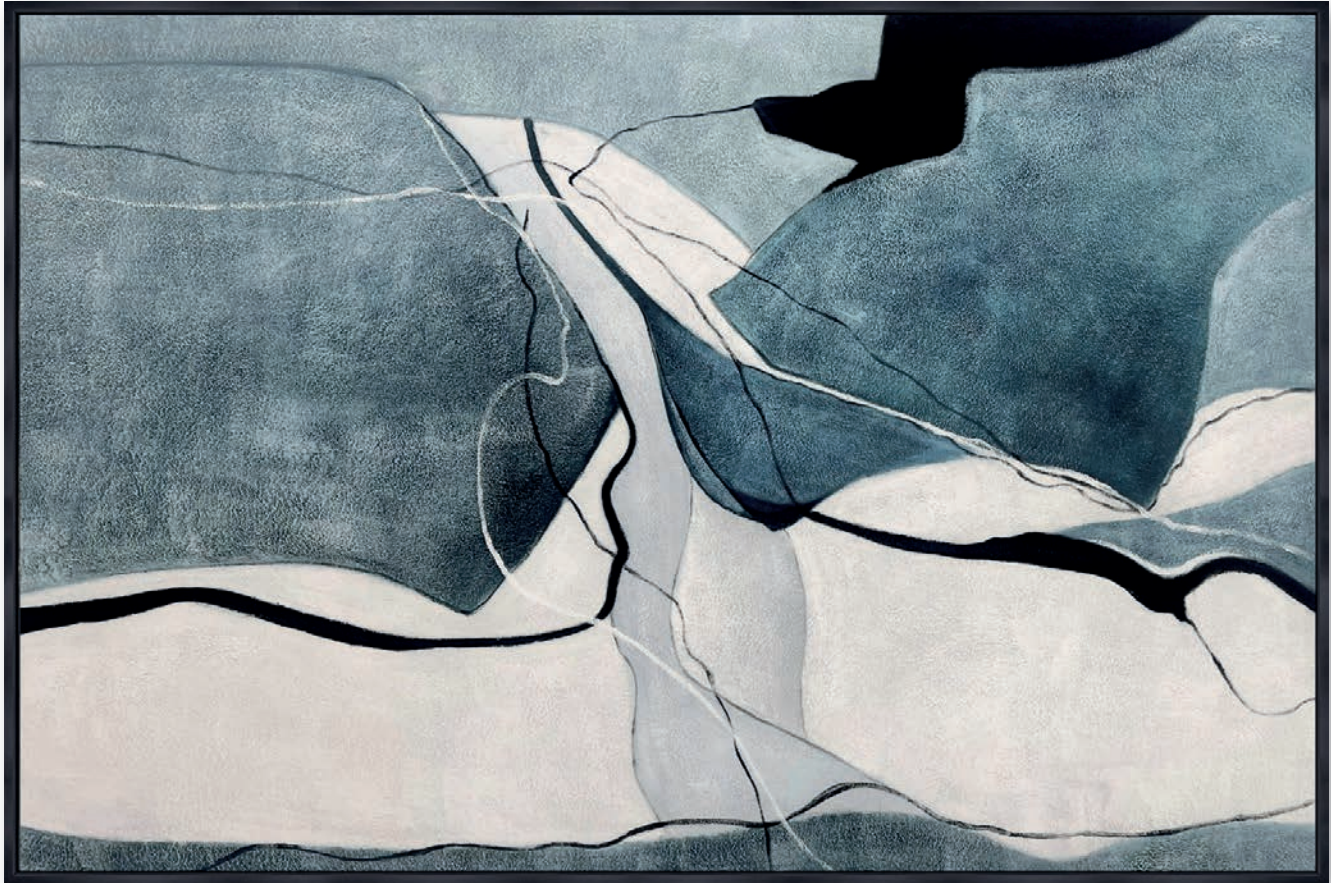

Cuadro 532
180*120 cm.
Marco negro

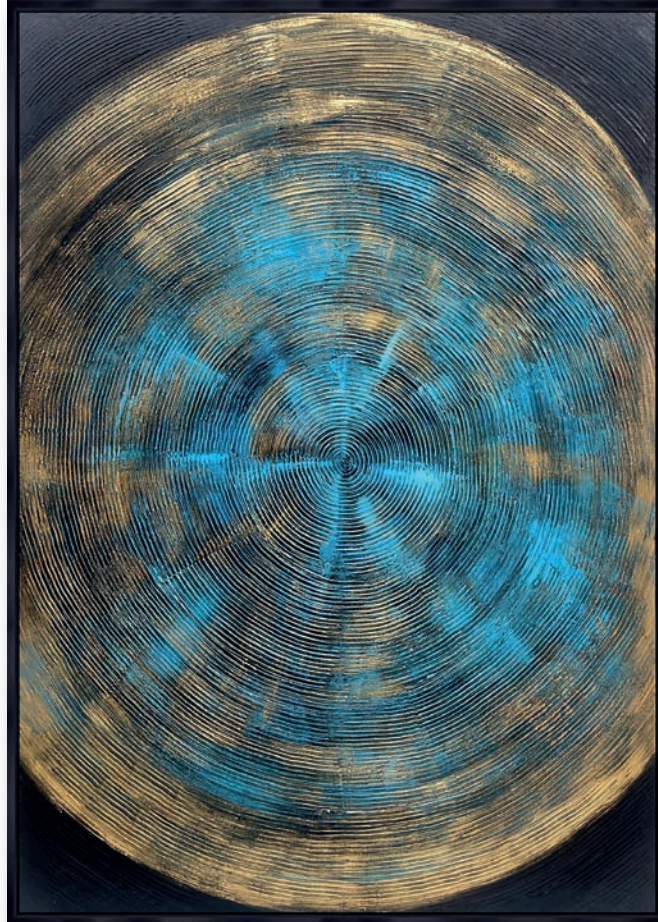

Cuadro 511
100*140 cm.
Marco negro

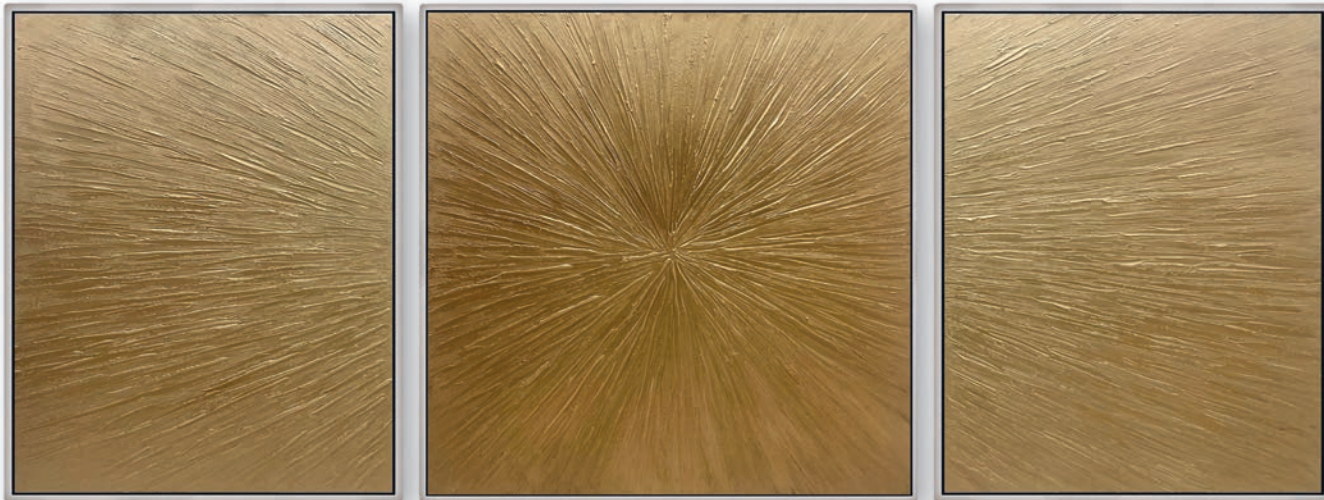

Pintado a mano

Cuadro 512T
260*100 cm. Tríptico (80*100/100*100/80*100 cm.)
Marcos plata



Cuadro 520T
260*100 cm. Tríptico (80*100/100*100/80*100 cm.)

Lienzos sin enmarcar



Cuadro 529T
260*100 cm. Tríptico 80*100 (3)
Marcos negros



Cuadro 515
160*60 cm.

Marco dorado

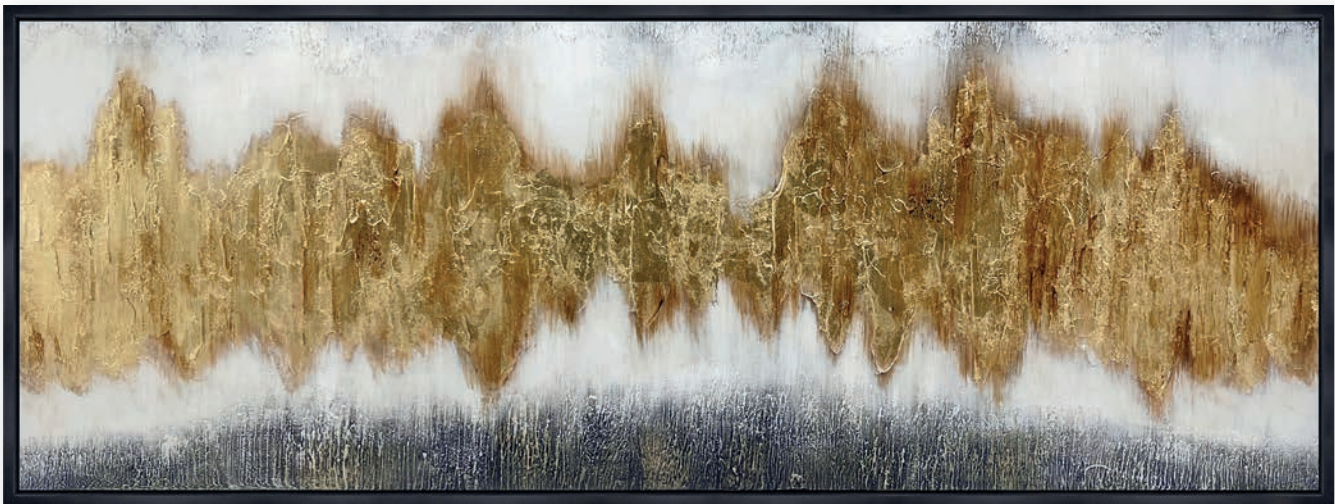

Pintado a mano

Cuadro 516
160*60 cm.

Marco negro



Cuadro 518
100*100 cm.

Marco plata

Características

Espejos para vestir y hacer sus paredes únicas.

Presentan distintos estilos y formas, con materiales diversos y algunos con marcos estilo vintage.

Las consolas de estilo vintage con suaves patinas y tonalidades combinan con los espejos según el estilo que elijan para su hogar.

Characteristics

Mirrors to decorate your walls and to make them unique.

Different styles and shapes in diverse materials, some with vintage-style frames.

The vintage-style consoles with soft patinas and gentle shades combine with the mirrors to bring the style you choose to your home.

Lineamenti

Specchi per vestire le vostre pareti e renderle uniche.

Realizzati con stili, forme e materiali diversi, alcuni con cornici dallo stile vintage.

Le console dallo stile vintage con patine leggere e tonalità delicate sono perfette da abbinare agli specchi, a seconda dello stile scelto per la sua casa.

Caracteristiques

Des miroirs pour décorer et personnaliser vos murs.

De différents styles et formes, avec différents matériaux, dont certains avec des cadres vintage.

Les consoles de style vintage aux patines et aux tons doux se combinent avec les miroirs selon le style que vous choisissez pour votre maison.



II

COLECCIÓN ESPEJOS Y CONSOLAS

Espejo 40058
Acabado níquel
61*4*185 cm.



Espejo vestidor 24701
Acabado bronce negro
80*210 cm.



Espejo 40056
Acabado níquel
57*3*132 cm.



Espejo 40063
Acabado níquel
71*3*91 cm.



Espejo 40031
Acabado latón anticuario
40*2,5*88 cm.



Espejo 40055
Acabado bronce
68*2*88 cm.



Espejo 30963-103
Acabado latón anticuario
Ø103*10 cm.

GRUPO MUEBLES
INTERMOBEL



Espejo 30963-76
Acabado azul cobalto
Ø76*15 cm.

Set de 3 espejos 190955
Acabado latón anticuario
37*59*2, 30*59*2 y 33*59*2 cm.



Espejo 40061
Acabado bronce
Ø91*3 cm.



Espejo 24226
Acabado níquel
Ø112*6 cm.





Espejo H-0806-D dorado
76*101,5 cm. marco metálico



Espejo H-0806-N negro
76*101,5 cm. marco metálico



Espejo H-1055-D dorado
Ø76 cm. marco metálico



Espejo H-1055-N negro
Ø76 cm. marco metálico



Espejo H-1051-D dorado
56*76 cm. (c/colgador 56*97 cm.)
Marco metálico

Espejo H-1051-N negro
56*76 cm. (c/colgador 56*97 cm.)
Marco metálico



Espejo H-1052-D dorado
Ø76 cm. (c/colgador 76*97 cm.)
Marco metálico



Espejo H-1052-N negro
Ø76 cm. (c/colgador 76*97 cm.)
Marco metálico

Espejo H-0101-N negro
Ø76 cm. marco metálico



Espejo H-0101-D dorado
Ø76 cm. marco metálico

Moldura redondeada



Espejo H-0102-D dorado
51*76 cm. marco metálico

Espejo H-1056-D dorado
Ø76 cm. marco metálico

Moldura plana





Espejo vestidor H-0103-D dorado
76*180 cm. marco metálico



Espejo vestidor H-0103-N negro
76*180 cm. marco metálico



Espejo H-0340-D Dorado
100*92*11 cm marco metálico



Espejo H-0340-N Negro
100*92*11 cm marco metálico



Espejo H-2754-D dorado
103*84 cm.
Marco metálico

Espejo H602
Plata veneciana
101 x 147 x 4 cm.



muebles
INTERMOBEL



Espejo H-2101-D dorado
Ø99 cm. marco metálico



Espejo H103 Plata Veneciana
89 x 145 cm.



Espejo Q-2406
60 x 80 cm.

Espejo Q-355A
60 x 103 cm.



Espejo vestidor H501
Plata patinada
89 x 178 cm.

Espejo H501
Plata satinada
99 x 130 x 4 cm.



**Espejo H602 Plata
Grey Veneciana**
101 x 147 x 4 cm.



Consola H134 con cajón.
Plata grey veneciana
120 x 35 x 79 cm.



Espejo H709
Plata Veneciana
90 x 120 x 10 cm.

GRUPO
MUEBLES
INTERMOBEL



Consola H134 con cajón
Plata Grey Veneciana
120 x 35 x 79 cm.

Espejo H100
Plata Veneciana
94 x 125 cm.



Consola H134 con cajón
Plata Grey Veneciana
120 x 35 x 79 cm.





Espejo Vestidor H506 Plata
65 x 170 x 5 cm.



Espejo H115 Plata veneciana
84 x 112 cm.

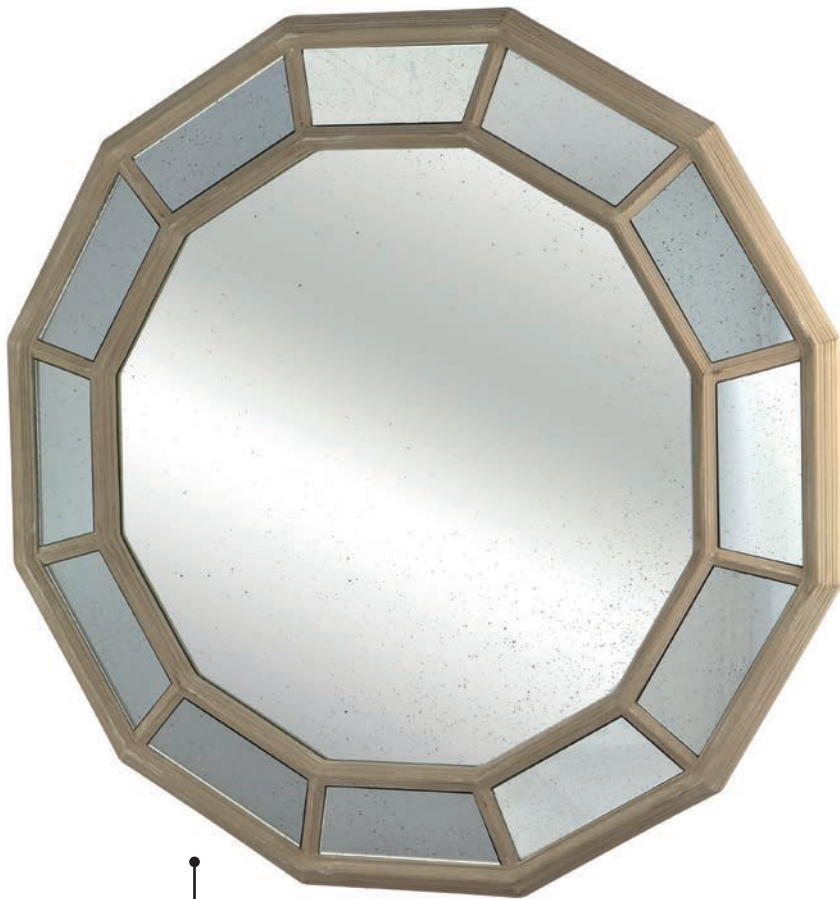

Espejo Q-2143
Luna efecto vintage
Ø 103 cm.

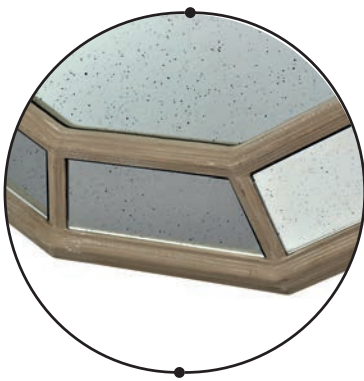

Espejo Q-1010
Ø 100 cm.

Espejo H179
84 x 112 x 4 cm.



Características

Mesas de centro, auxiliares, muebles TV, consolas y escritorios realizados en cristal templado de espíritu minimalista que destilan claridad y ligereza.

Characteristics

Coffee tables, side tables, console tables, TV stands and desks made of glass or tempered glass with a minimalist design that creates the illusion of light and space.

Lineamenti

Tavolini da salotto, tavolini ausiliari, mobili TV, tavoli consolle e scrivanie realizzate in vetro o vetro temperato, in linea con lo spirito minimalista, che sprigionano luminosità e leggerezza.

Caracteristiques

Tables basses, meubles d'appoint, meubles TV, consoles et bureaux en verre ou en verre trempé au design simple pour plus de clarté et de légèreté.



I2
COLECCIÓN
MESAS DE CRISTAL



Chaise Longe H12

Piel negra o blanca
160 x 62 x 70 cm.



Mesa Círculos

Cristal templado 12 mm.
80/136 x 80 x 42 cm.

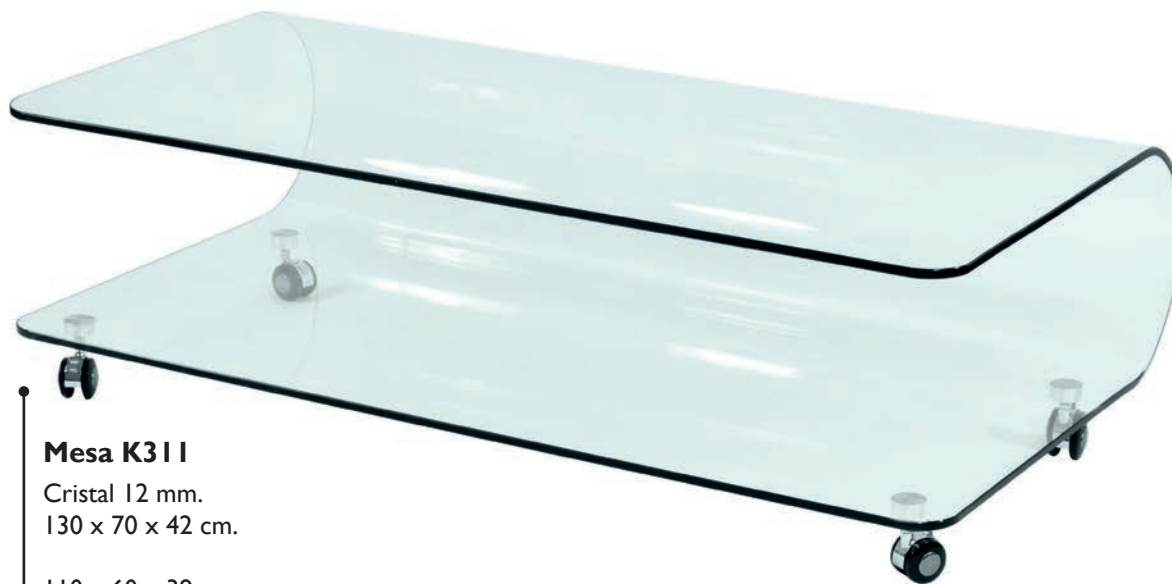

Mesa K311

Cristal 12 mm.
130 x 70 x 42 cm.

110 x 60 x 39 cm.

muebles
GRUPO **INTERMOBEL**



Mesa 1209

Cristal templado 12 mm.
120 x 60 x 38 cm.



Mesa 4035

Cristal templado 12 mm.
120 x 70 x 40 cm.



Mesa K006

Cristal templado 12 mm.
110 x 55 x 35 cm.



Mesa K202

Cristal Templado 12 mm.
Base inferior madera lacada blanco
110*55*35 cm.

GRUPO **INTERMOBEL**

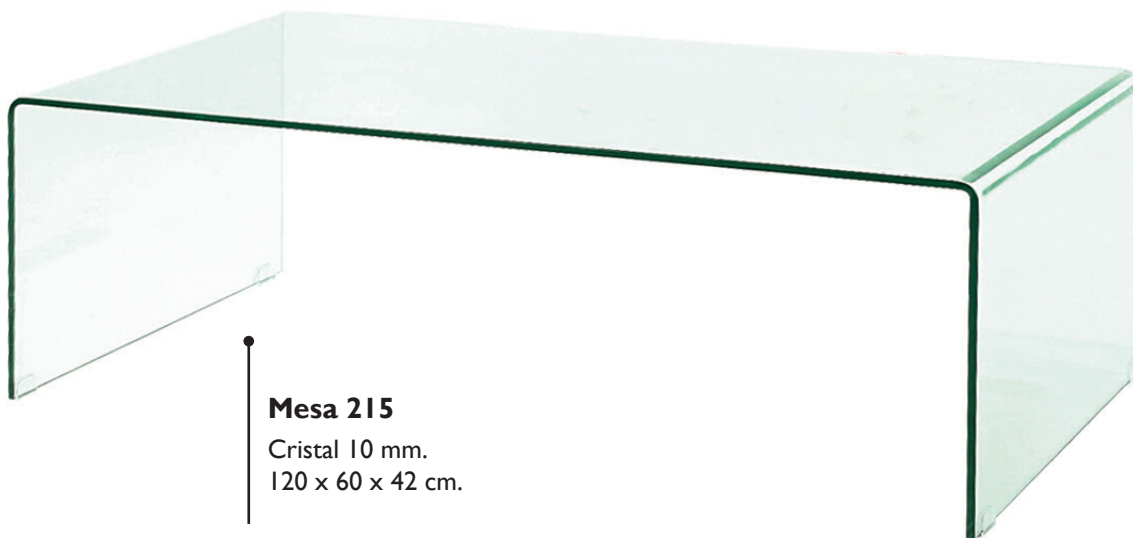

Mesa 215

Cristal 10 mm.
120 x 60 x 42 cm.

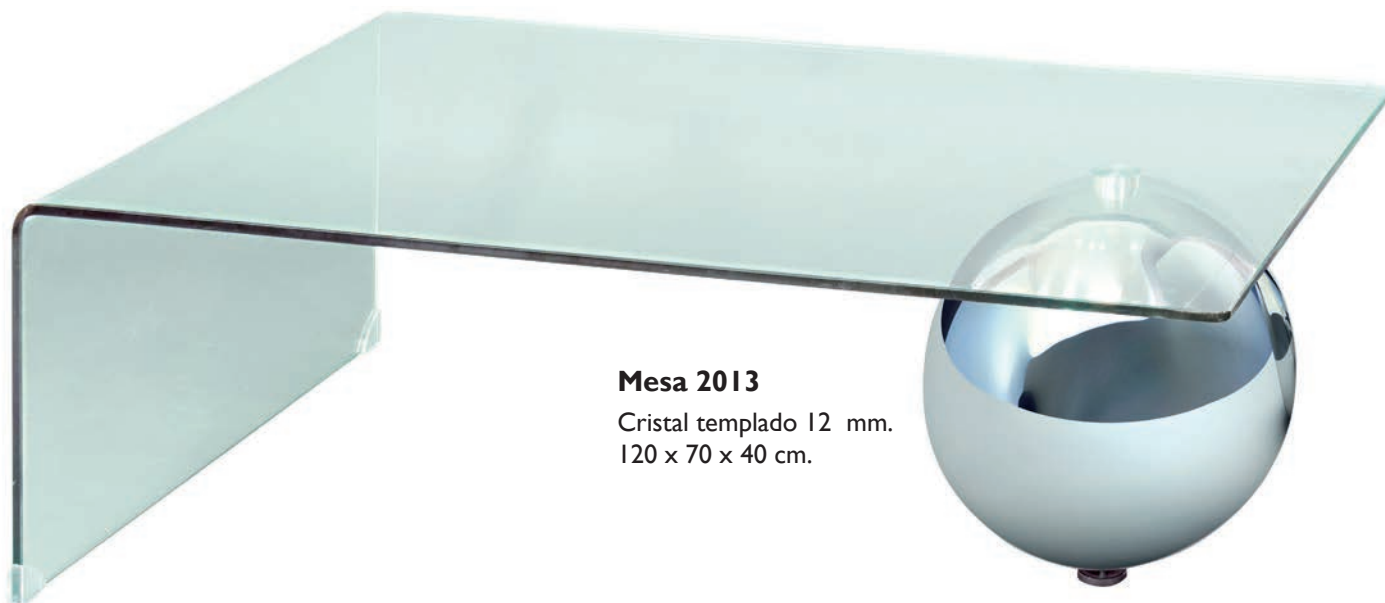

Mesa 2013

Cristal templado 12 mm.
120 x 70 x 40 cm.



Mesa 206

Cristal 10 mm.
110 x 55 x 35 cm.

GRUPO **INTERMOBEL**



Mesa K116

Cristal templado
SUP. 12 mm. INF: 8 mm.
110 x 55 x 35 cm.

Mesa Círculos
 Acero inox.
 Cristal templado 12 mm.
 80/136 x 80 x 42 cm.



CERRADA



ABIERTA



Mesa Rincón D19
 Ø53 x 67 cm.
 Regulable en altura



Mesa Auxiliar B-012
 Cristal templado 8 mm.
 Base en mármol.
 Ø 55 x 60 cm.



CERRADA

Mesa Aire 90/156 x 60 x 44 cm.

Cristal templado 12 mm.

Base acero inox.

Base blanca

muebles
INTERMOBEL

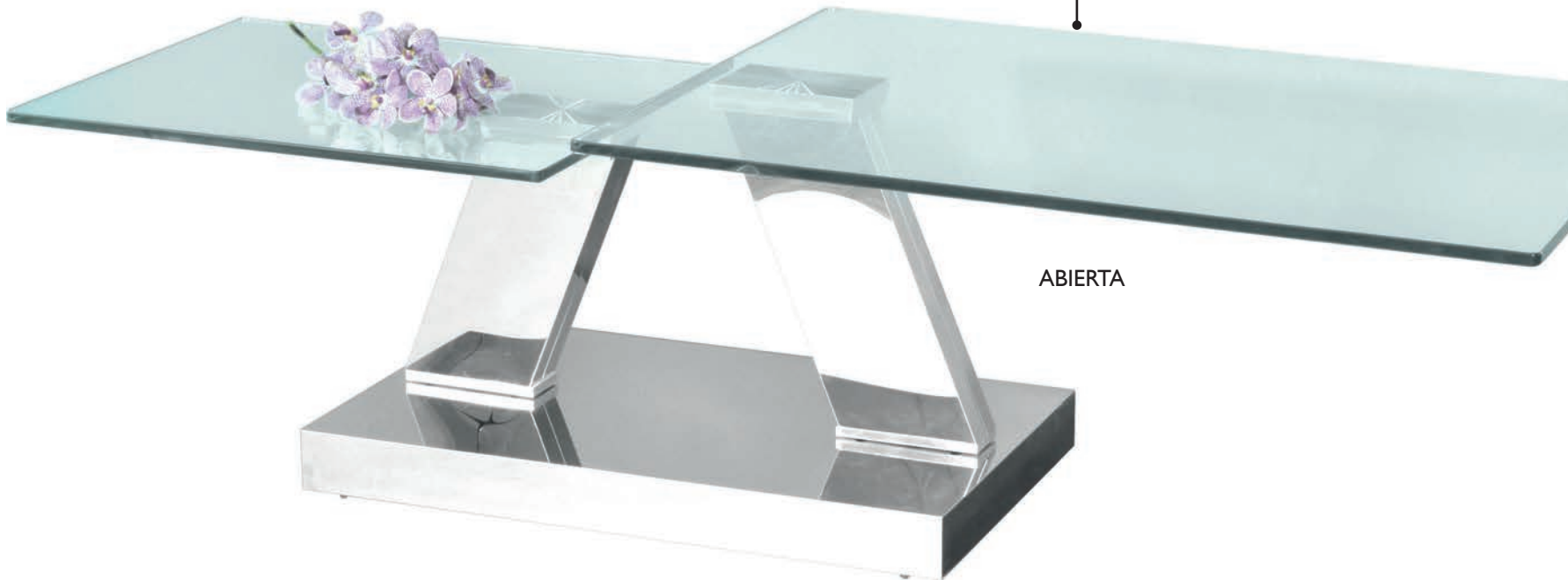

ABIERTA

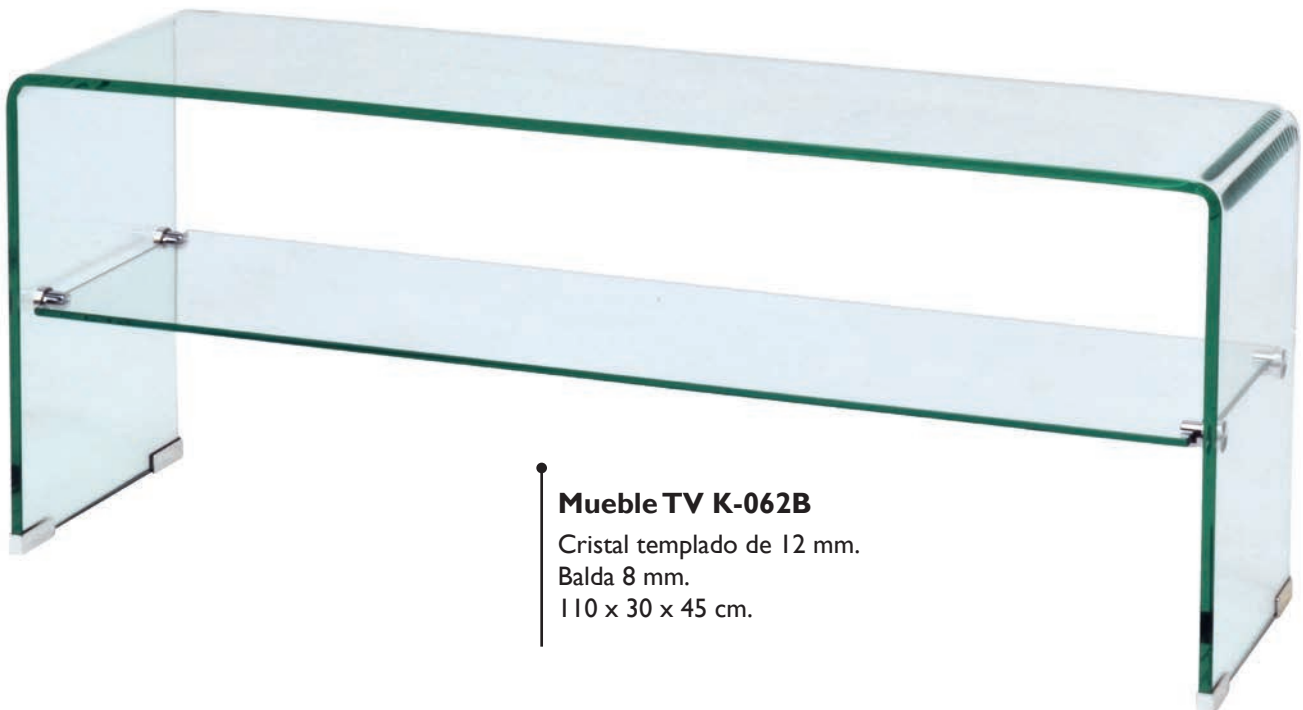

Mueble TV K-062B

Cristal templado de 12 mm.

Balda 8 mm.

110 x 30 x 45 cm.

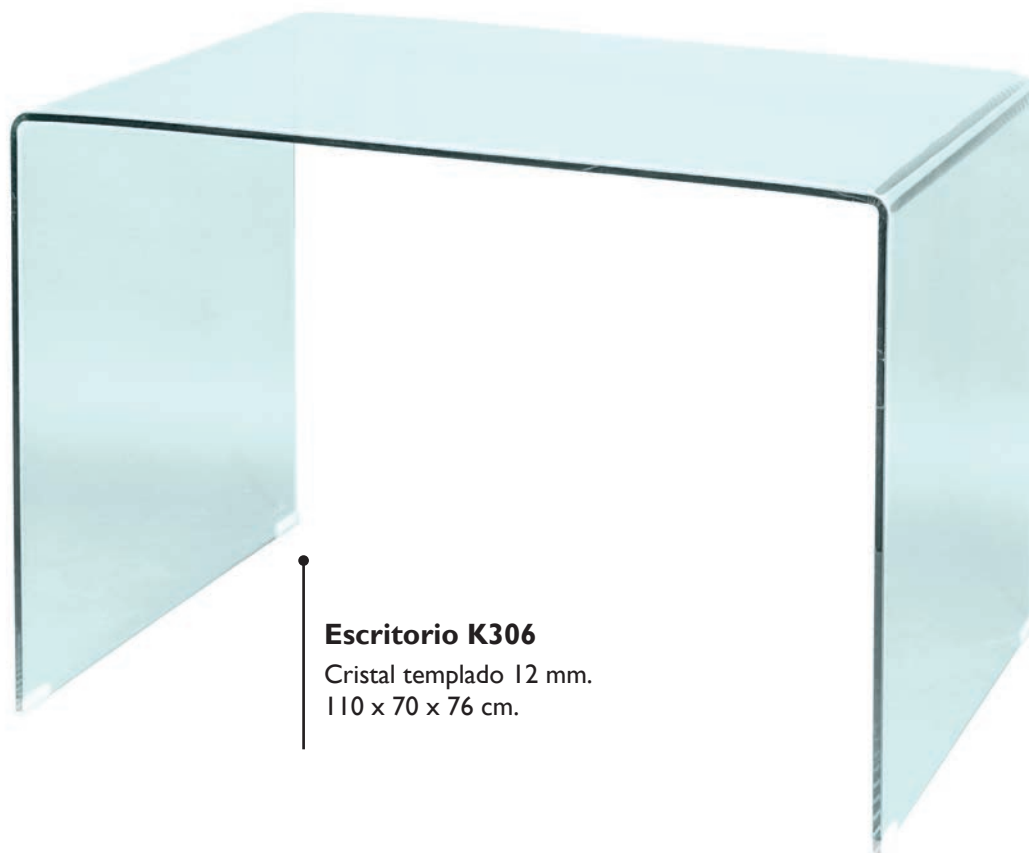

Escritorio K306

Cristal templado 12 mm.
110 x 70 x 76 cm.



Mesa rincón K045

Cristal 12 mm.
50 x 41 x 60 cm.



Mueble Auxiliar K049

2 Baldas
Cristal 10 Mm.
40 x 40 x 60 cm.



Mueble Auxiliar K049

3 Baldas
Cristal 10 Mm.
40 x 40 x 80 cm.



Mesa 1213
Cristal templado 12 mm.
50 x 50 x 47 cm.



Carro K051
Cristal 12 mm.
42 x 37 x 69 cm.

GRUPO **INTERMOBEL**



Mesa 637
Cristal 10 mm.
40x40x50 cm.



Set 3 Mesas 1218
Cristal templado de 12 mm.
46 x 46 x 46 cm.
42 x 42 x 42 cm.
38 x 38 x 38 cm.

Mesa 636
Cristal 10 mm.
45 x 40 x 55 cm.

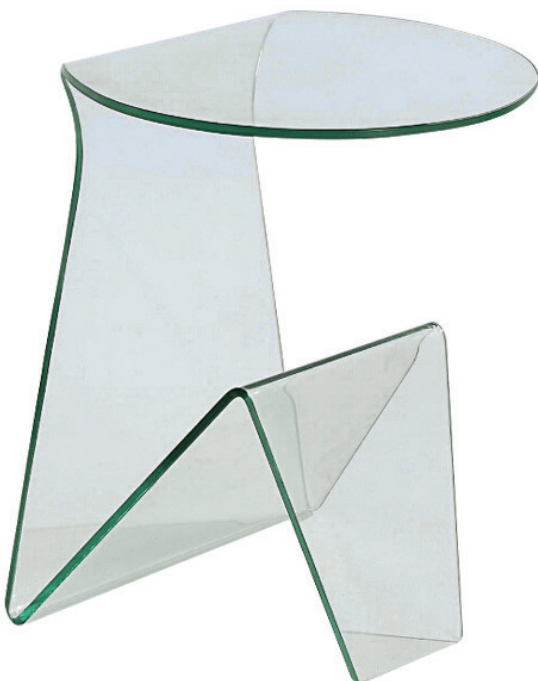

Carro K-052
Cristal 12 mm.
45 x 40 x 58 cm.

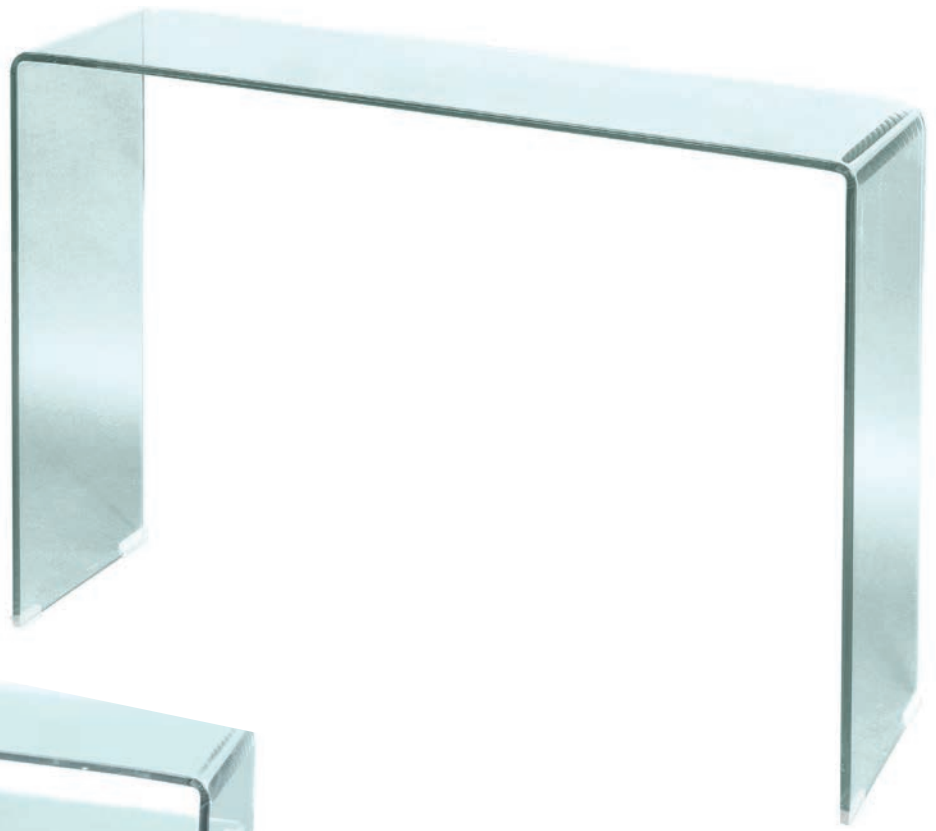

Consola K062
Cristal templado 12 mm.
110 x 30 x 76 cm.



Consola K062B con balda
Cristal templado Sup. 12 mm. Inf.: 8 mm.
110 x 30 x 76 cm.



Consola K-710
Cristal templado de 12 mm.
Bandejas MDF chapado
125 x 40 x 76 cm.

Características

Diseños originales de mesas para salón, auxiliares y escritorios.

Las tapas de MDF 18 mm. con chapa de roble y en algunos modelos pintadas PU blanco.

Las patas en estructura de metal pintado en negro o en madera de roble.

Characteristics

Original table designs for the living room, side tables and desks.

The 18 mm-thick MDF is finished with oak veneers, and some models are painted PU white.

The legs of the metal structure are painted black or oak wood.

Lineamenti

Design originali di tavoli da soggiorno, tavolini e scrivanie.

Piani in MDF 18 mm impiallacciati in rovere, con alcuni modelli verniciati in PU bianco.

Gambe con struttura metallica verniciate di nero o in legno di rovere.

Caracteristiques

Des conceptions originales de tables pour salon, tables d'appoint et bureaux.

Les planches sont en MDF 18 mm avec placage de chêne et certains modèles sont peints PU blanc.

Les pattes présentent une structure en métal peint en noir ou en bois de chêne.



13
COLECCIÓN
HACHE



**Mesa de centro H-9628
BLANCA**
Tapa MDF 18 mm. pintada
PU BLANCO, patas madera de roble
110*50*40 cm

muebles
INTERMOBEL



Set 3 mesas H-9655 BLANCAS
Tapas MDF 18 mm. pintadas PU BLANCO
patas madera de roble
Ø48*45 / Ø40*40 / Ø30*35 cm.



Set 2 mesas H-9363 ROBLE
Tapas MDF 18 mm. chapa de roble,
patas madera de roble
Ø50*45 / Ø40*40 cm.



Set 2 mesas H-9363 BLANCO
Tapas MDF 18 mm. pintadas
PU BLANCO, patas madera de roble
Ø50*45 / Ø40*40 cm.



Set 2 mesas H-9360 BLANCO

Tapas MDF 18 mm. pintadas PU
BLANCO, patas madera de haya
116*66*45/75*43*39 cm.



Mesa rincón H-9933

Tapas MDF 18 mm. pintadas PU
BLANCO, patas madera de roble
60*50*55 cm.

GRUPO m u e d i e s
INTERMOBEL



Set 2 mesas H-9990

Tapas MDF 18 mm. pintadas PU
BLANCO, patas roble
Ø80*40 / Ø50*45 cm.



Escritorio H-9612
 MDF 18 mm. y soportes metálicos
 pintados PU BLANCO, cajones chapa
 de roble, patas madera de roble.
 Desmontado.
 120*45*75 cm.

GRUPO MUEBLES
INTERMOBEL



Silla ESTUDIO
 Blanca/patas
 cromadas con ruedas
 55*48*84 cm.
 Altura asiento: 45/55 cm.



Escritorio H-9809
 Tapas MDF 18 mm. y estructura
 metálica pintadas PU BLANCO,
 patas madera de roble.
 Desmontado.
 120*60*76 cm.



Set 2 mesas H-9360 ROBLE
Tapas MDF 18 mm. chapa de roble,
patas madera de roble
100*50*40/70*35*35 cm.

Set 2 mesas H-1310
Tapas MDF 18 mm. chapa de roble,
estructura metal pintado negro
Ø80*45 / Ø50*38 cm.



Set 2 mesas H-1311
Tapas MDF 18 mm. chapa
de roble, estructura metal
pintado negro
Ø50*50 / Ø40*45 cm.



Set 2 mesas H-1544

Tapas MDF 18 mm. chapa de roble, estructura metal pintado negro
 Ø80*45 / Ø55*41 cm.



Mesa rincón H-1219

Tapa removible MDF 18 mm. chapa de roble, estructura metal pintado negro
 Ø48*45 cm



Mesa de centro H-9986

Tapa MDF 18 mm. chapa de roble, estructura metal pintado negro
 Ø80*40 cm.



Estantería H-19008 Roble
118 mm. tablero MDF chapa roble,
Estructura metálica negra
120*39*165 cm.



Auxiliar H1335
Tapas MDF 18 mm. cha-
pa de roble, estructura
metal pintado negro
45*68 cm.



Características

Originales aparadores destinados a protagonizar la zona living, fabricados en maderas exóticas como Sheesam o Mango, con estructuras en madera o metal y puertas labradas con bonitos motivos en madera, chapa de latón o pinturas de llamativos colores.

Todas las mesas llevan estructura metálica, acabadas en negro o latón anticuario, las tapas en distintos tonos de metal combinando el latón anticuario, antracita, níquel, cobre e incluso el color bronce.

Characteristics

Original dressers designed to stand out in your living room, made from exotic woods like Indian rosewood or mango, with wooden or metal structures and doors with attractive carved motifs in wood, brass or eye-catching, colourful paint.

All these tables feature metal structures with a black or antique brass finish. The tabletops come in different shades of metal, including antique brass, anthracite, nickel, copper and even bronze.

Lineamenti

Originali credenze destinate ad essere le protagoniste della zona giorno, realizzate con legni esotici come il legno di Sheesham o di Mango, con strutture in legno o metallo e ante lavorate con splendidi motivi in legno, lamiera di ottone o vernici dai colori vivaci.

Tutti i tavoli sono dotati di una struttura metallica con finiture nere o in ottone anticato, mentre i piani in diverse tonalità di metallo abbinano ottone anticato, antracite, nichel, rame e, perfino, il color bronzo.

Caracteristiques

Des bahuts originaux destinés à être les vedettes de l'espace de vie, confectionnés de bois exotiques tels que le sheesam ou le manguier, avec des structures en bois ou en métal et des portes sculptées de beaux motifs en bois, en tôle de laiton ou de peintures de couleurs vives.

Toutes les tables sont dotées d'une structure métallique, finies en noir ou en laiton antique, les lateaux en différentes nuances de métal combinant le laiton antique, l'antracite, le nickel, le cuivre et même le bronze.



I 4
COLECCIÓN
BELLA



Aparador HIMALAYA
Cuerpo de madera de Sheesam
Puertas chapadas en latón anticuario
160*40*80 cm.



Aparador MASAYA
Cuerpo de madera de Mango natural
Puertas talladas
123*42*78 cm.



Aparador ANDES
 Cuerpo de madera
 de acacia
 Puertas chapadas en
 latón y esmalte
 95*40*80 cm.

GRUPO **INTERMOBEL**



Aparador TEIDE
 (Dos unidades)
 Estructura de
 metal negro
 Puertas de madera
 tosca natural
 80*40*80 cm.



Mesa 50167-80

Tapa vidrio fundido, estructura
acabado latón anticuario.
Ø80*37 cm.



Mesa 31032
Tapa vidrio fundido
y estructura acabado
dorado claro
Ø80*39 cm.

muebles
GRUPO **INTERMOBEL**



Mesa 25146 Vidrio
Tapa vidrio fundido,
estructura acabado
bronce fundido
Ø80*38 cm.



Mesa centro 27391-100GN
Tapa mármol gris, estructura negra
100*100*40 cm.



Mesa centro 27391-100BL
Tapa mármol blanco,
estructura acabado latón
100*100*40 cm.



Mesa centro 22380-120GN
Tapa mármol gris, estructura negra
120*70*35 cm.

muebles
INTERMOBEL



Mesa centro 22380-120BL
Tapa mármol blanco, estructura acabado latón
120*70*35 cm.



Mesa centro 27391-122GN
Tapa mármol gris, estructura negra
122*61*40 cm.



Mesa centro 27391-122BL
Tapa mármol blanco, estructura acabado latón
122*61*40 cm.



Mesa centro 27391-122LN
Tapa acabado latón anticuario,
estructura negra
122*61*40 cm.



Mesa centro 27343
Tapa superior cristal 10 mm.
Tapa inferior acabado latón anticuario "sun ray",
estructura negra
96*96*38 cm.





Mesa 24492
Tapa acabado latón anticuario,
base negra
Ø90*41 cm.

GRUPO m u e d i e s
INTERMOBEL



Set 2 mesas 21189
Acabado bronce oscuro
y latón anticuario
Ø76*46 y Ø66*38 cm.



Set 3 mesas 50113
 Acabados Plata, latón anticuario
 y bronce oscuro
 Ø75*40, Ø51*36 y Ø51*36 cm.

muebles
INTERMOBEL



Set 2 mesas 23871
 Tapas acabado níquel y cobre,
 estructura negra
 Ø75*44 / Ø65*39 cm.



Set 3 mesas 26225
Acabado latón anticuario
Ø75*35 - Ø30*40 (2) cm.

GRUPO **INTERMOBEL**



Set 2 mesas 26224
Acabado níquel
Ø66*30 y Ø56*25 cm.



Set 3 mesas 23873
Tapas acabado latón anticuario,
estructura negro
82*82*42 / (2) 74*38*38 cm.

muebles
GRUPO
INTERMOBEL



Set 2 mesas 20557-B
Tapas acabado latón anticuario,
estructura en negro mate.
90x90x40 / 60x60x35 cm.



Set 2 mesas 25582-80
 Acabado latón anticuario y
 bronce, estructura negra
 80*80*40 / 70/70*35 cm.

GRUPO muebles
INTERMOBEL

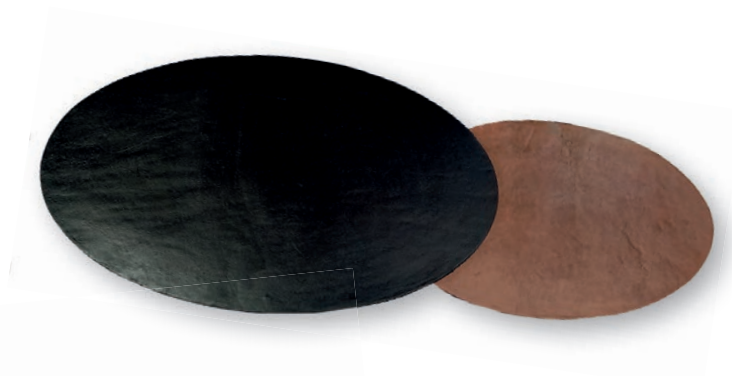

Detalle tapas OVALADAS



Set 2 mesas OVALADAS 24423
 Acabado bronce oscuro y cobre
 anticuario estructura negra
 104*61*46/85*49*38 cm.

Set 2 mesas 25582-60
Acabado latón anticuario y bronce,
estructura negra
60*40*60 / 50*35*50 cm.



muebles
INTERMOBEL



Set 2 mesas 50403
Tapa vidrio fundido,
estructura acabado latón anticuario
Ø61,5*46*49 y Ø56*41 cm.

Set 2 mesas 20557-A
Tapas acabado cobre, estructura negro
40*40*41 / 35*35*37 cm.



Set 2 mesas 21582
Tapas acabado latón anticuario,
estructura negro mate
62*62*41 / 46*46*45 cm.

GRUPO **INTERMOBEL**

Set 2 mesas 26996
Tapa superior marmol gris,
inferior mármol blanco
estructura negra
50*40*48 / 42*33*40 cm.





Set de 2 mesas 22865
 Latón anticuario y niquel,
 estructura negra
 40*40*56 y 46*31*62 cm.

GRUPO
INTERMOBEL

Detalle acabados



Set de 3 mesas 50441
 Tapas acabados latón anticuario,
 bronce oscuro y niquel
 estructura negra
 60*50*54, 50*43*49 y 41*34*43 cm.



Set 3 mesas 25517
 Tapas esmaltes, estructuras negro
 48*48*59/41*41*53,5/33*33*48

muebles
INTERMOBEL



Set 3 mesas 20457-B
 Tapas acabado níquel, estructura negra
 41,5*41,5*61 / 36*36*56 / 31*31*50 cm.



Set 3 mesas 20457-A
 Tapas acabado latón anticuario, bronce
 y níquel, estructura negra
 41,5*41,5*61 / 36*36*56 / 31*31*50 cm.



Set 2 mesas 22549
 Tapas acabado latón anticuario
 y níquel, estructura negra
 Ø41*55 / Ø37*49 cm.



Set 2 mesas 22577
 Tapa acabado bronce escultura
 y latón anticuario, estructuras negro
 56*30*47 / 48*26*36 cm.

muebles
INTERMOBEL



Set 3 mesas 22570
 Tapas acabado latón anticuario,
 antracita y níquel, estructura negra
 Ø41*51/Ø38*45/Ø31*40 cm.



Mesa 30948-49
Tapa vidrio fundido
estructura acabado latón anticuario
Ø40*49 cm



Mesa 30948-41
Tapa vidrio fundido
estructura acabado bronce oscuro
Ø33*41 cm.

Set 2 mesas 50432
Tapa vidrio fundido,
estructura negra
37*25*46 y 43*33,5*43 cm.



Mesa 31033-48
Tapa vidrio fundido
estructura acabado latón anticuario
Ø29*48 cm.



Mesa 31033-65
Tapa vidrio fundido
estructura acabado bronce oscuro
Ø34*65 cm.



GRUPO muebles
INTERMOBEL

Mesa 22384-53
45*47*53 cm.

Tapas verde bhatti patinada,
bases acabado latón anticuario



Mesa 22384-72
70*72*47 cm.

Mesa 20399-48
Acabado latón anticuario
Ø46*48 cm.



Mesa 20399-59
Acabado latón anticuario
Ø59*49 cm.



Tapas acabado latón anticuario,
estructuras color negro

Mesa 21998-62
Ø42*62 cm.

Mesa 21998-58
Ø42*58 cm.

Mesa 21998-53
Ø42*53 cm.



Mesa 50117

Tapa vidrio fundido,
estructura acabado latón anticuario
Ø41*50 cm.



Mesa 31036-57

Tapa vidrio fundido,
estructura acabado latón anticuario.
45*45*57 cm.



Mesa 31035

Tapa vidrio fundido
estructura acabado latón anticuario
Ø41*56 cm.



Mesa 31037

Tapa vidrio fundido y estructura
acabado dorado claro
Ø45*56 cm.



Mesa 50108

Tapa y estructura acabado
latón anticuario
Ø73*77 cm.



Mesa 50129

Mesa mármol Baswara, base
acabado latón anticuario
Ø70*52 cm.



Mesa auxiliar 24761
Tapa acabado latón mate,
estructura negra
51*26*61 cm.

muebles
GRUPO
INTERMOBEL



Mesa 18368
Acabado bronce oscuro
envejecido
Ø42*62 cm.



Mesa rincón 24791
Acabado bronce oscuro envejecido
Ø40*50 cm.



Mesa 24488
Tapa acabado latón anticuario,
base negra
Ø47*56 cm.

Mesa auxiliar 27018BL
Tapa mármol blanco,
base acabado latón
Ø40*58 cm.



Mesa 25519
Tapa acabado latón anticuario,
base negra
Ø55*40 cm.



Mesa 22102

Acabado latón anticuario,
estructura negra
Ø45*53 cm.



Mesa 50375

Tapas acabado bronce oscuro
y níquel oscuro patinado.
Estructura negro mate.
51*31*60 cm.



Estantería 24489

Tapas acabado plomo anticuario
estructura negra
51*36*76 cm.



Set 2 consolas 20466
 Tapas acabado latón anticuario,
 estructura negro mate
 117*25*80 / 100*25*70 cm.

GRUPO
 muebles
INTERMOBEL



Bandeja 60064
 Acabado latón anticuario
 56*16*23 cm.



Auxiliar 20546
 Tapa acabado niquel,
 estructura negro mate
 Ø25*65 cm.

Macetero 24702-G
Acabado níquel, base negra
Ø34*75 cm.



Macetero 24702-M
Acabado níquel, base negra
Ø30*60 cm.



Macetero 24702-P
Acabado níquel, base negra
Ø29*50 cm.



Vaso 24666-123
Acabado níquel
Ø36*123 cm.



Vaso 24666-92
Acabado níquel
Ø27*92 cm.



Vaso 24666-79
Acabado níquel
Ø25*79 cm.



Portavelas 22955-60
Acabado latón anticuario
20*20*60 cm.



Portavelas 22955-76
Acabado bronce oscuro
26*26*76 cm.



**Portavelas
12312-68**
Acabado níquel
24*24*68 cm.



**Portavelas
12312-55**
Acabado níquel
24*24*55 cm.



Portavelas 60514-75
Bronce negro
35*35*75 cm.



Portavelas 60514-59
Latón antiguo
27*27*59 cm.



muebles
GRUPO INTERMOBEL

Portavelas 22439-93
Cristal fundido y
estructura níquel negro
Ø28*93 cm.



Portavelas 22439-73
Cristal fundido y
estructura níquel negro
Ø28*73 cm.



Características

Sillones con reposapiés, butacas, sillas, chaise longues y mesas donde el diseño más auténtico en madera, piel y acero es un puro reflejo de los tiempos actuales.

Characteristics

Armchairs with footrests, recliners, chaises longues and tables boasting original wood, leather and steel designs that reflect a contemporary style.

Lineamenti

Poltrone con poggiatesta, poltrone, sedie, chaise longue e tavoli il cui disegno più autentico in legno, pelle e acciaio è il puro riflesso della contemporaneità.

Caracteristiques

Fauteuils munis de repose-pieds, fauteuils, chaises, chaises longues et tables en bois, en cuir ou en acier dont le design authentique reflète à merveille notre époque.





I5
COLECCIÓN
CLÁSICOS DEL DISEÑO



Sofá B-810 2 plazas
Piel negra
145 x 70 x 70 cm.
Altura asiento: 44,5 cm.

Mesa auxiliar B-012
Cristal templado 8 mm.
Base en mármol
Ø55 x 60 cm.

Sofá B-810 1 plaza
Piel negra
88 x 70 x 70 cm.
Altura asiento: 44,5 cm.

Mesa B-015
Chapa nogal
67,5 x 35,5 x 40 cm.

Sofá B-810 3 plazas
Piel negra
196 x 70 x 70 cm.
Altura asiento: 44,5 cm.



Sofá B-810 1 plaza
Piel blanca
88*70*70 cm
Altura asiento: 44,5 cm.

Sofá B-810 3 plazas

Piel blanca
196*70*70 cm
Altura asiento: 44,5 cm.



muebles
GRUPO **INTERMOBEL**



Sofá B-810 2 plazas

Piel blanca
145*70*70 cm
Altura asiento: 44,5 cm.



Chaise longue H12
Piel negra
160 x 62 x 70 cm.

muebles
INTERMOBEL



Chaise longue H12
Piel vaca
160 x 62 x 70 cm.



GRUPO
MUEBLES
INTERMOBEL

Foto sobre cristal 042
150*100 cm.



Chaise LONGUE H12

Piel blanca
160 x 62 x 70 cm.



Sillón giratorio T044

83*82*84,5 cm.
Altura asiento: 40 cm.
Altura brazo: 50 cm.

Reposapies fjo T044

64*54*44 cm.



PIEL BLANCA - MADERA DE HAYA

GRUPO
muebles
INTERMOBEL

Sillón giratorio T044

83*82*84,5 cm.
Altura asiento: 40 cm.
Altura brazo: 50 cm.

Reposapies fjo T044

64*54*44 cm.



PIEL NEGRA - MADERA DE ROSEWOOD (PALISANDRO)

Sillón giratorio T044

83*82*84,5 cm.
Altura asiento: 40 cm.
Altura brazo: 50 cm.

Reposapies fjo T044
64*54*44 cm.

Foto cristal 039
100x150 cm. 16,5 kg.

Mesa 20399-48
Acabado latón anticuario
Ø46*48 cm.

PIEL MARRÓN - MADERA DE ROSEWOOD (PALISANDRO)



Mecedora T034

Piel blanca
65 x 97 x 94 cm.
Altura asiento: 42 cm.
Altura brazo: 64 cm.



Silla B-3601

Chapa nogal y piel negra
Altura asiento: 40 cm.
Altura brazos: 51 cm.
89 x 75 x 75 cm.



Mesa B-015

Chapa nogal
67,5 x 35,5 x 40 cm.



Mesa B-033

Chapa nogal
Ø 85 x 45 cm.



Butaca y Reposapiés T03

Piel blanca
Sillón 75 x 75 x 76 cm.
Altura asiento: 45 cm.

Reposapiés 65 x 65 x 43 cm.



Butaca y Reposapiés T03

Piel negra
Sillón 75 x 75 x 76 cm.
Altura asiento: 45 cm.

Reposapiés 65 x 65 x 43 cm.



Características

Sillas que marcan las tendencias decorativas más actuales, distintos estilos, con o sin brazos en madera y piel (Split leather), madera y tapizado tela o solo madera.

Por su versatilidad darán un toque de originalidad a sus hogares.

Characteristics

Chairs designed to set the latest décor trends, with or without armrests in wood and split leather, wood with fabric upholstery or simply solid wood.

Their versatile design will bring a touch of originality to your home.

Lineamenti

Sedie che fanno tendenza nel mondo dell'arredamento, differenti stili, con o senza braccioli in legno e pelle (Split leather), in legno e rivestite in tessuto o solo in legno.

Grazie alla loro versatilità daranno un tocco di originalità alle vostre case.

Caracteristiques

Chaises de différents styles qui reflètent au mieux les tendances actuelles en matière de décoration. Avec ou sans bras, elles sont disponibles en bois et cuir (cuir fendu), en bois recouvert par du tissu ou uniquement en bois.

Leur multifonctionnalité donnera une touche d'originalité à votre habitat.

G R U P O
INTERMOBEL



I 6
COLECCIÓN
SILLAS Y BUTACAS



**Sillón WILSON
ROBLE TINTADO**
48*50*90 cm.
Altura asiento: 46 cm.
Altura brazos: 68 cm.



**Sillón WILSON
NATURAL**
48*50*90 cm.
Altura asiento: 46 cm.
Altura brazos: 68 cm.



**Sillón WILSON
BLANCO PATINADO**
48*50*90 cm.
Altura asiento: 46 cm.
Altura brazos: 68 cm.

GRUPO muebles
INTERMOBEL

**Taburete WILSON
BLANCO PATINADO**
46 x 42 x 118 cm.
Altura asiento: 72 cm.



Silla WILSON
Apilable
46*42*87 cm.
Sólo disponible
en los acabados
ROBLE TINTADO
y NATURAL



Detalle de la diferencia
con la silla NO apilable

**Silla WILSON
ROBLE TINTADO**
46*42*87 cm.
Altura asiento: 46 cm.



**Silla WILSON
BLANCO PATINADO**
46*42*87 cm.
Altura asiento: 46 cm.



GRUPO muebles
INTERMOBEL

Silla FERRO
Natural (cruz metálica)
46 x 42 x 87 cm.
Altura asiento: 46 cm.



Silla WILSON
Blanco Ambiente
46 x 42 x 87 cm.
Altura asiento: 46 cm.



Silla WILSON NATURAL
46*42*87 cm.
Altura asiento: 46 cm.



Silla QUEBEC
49 x 56 x 97 cm
Altura asiento: 46 cm.



Silla TRENTO
56 x 60 x 100 cm.
Altura asiento: 49 cm.



Silla AMBIENTES
Color vainilla.
54 x 53 x 102 cm.
Altura asiento: 46 cm.



GRUPO **INTERMOBEL**

**Silla PAOLA
NATURAL**
45*42*86 cm.
Altura asiento: 47 cm.



**Silla PAOLA
ROBLE TINTADO**
45*42*86 cm.
Altura asiento: 47 cm.



**Silla PAOLA
BLANCO PATINADO**
45*42*86 cm.
Altura asiento: 47 cm.





Silla RATÁN 10056
44*60*84cm.
Altura asiento: 48 cm.

Silla WINDSOR

Color crema y nogal
44 x 48,5 x 91,4 cm.
Altura asiento: 44 cm.



Sillón RATÁN 9988

Con cojín
60*64*90 cm.
Altura asiento: 45 cm.
Altura brazos: 68 cm.

GRUPO MUEBLES
INTERMOBEL



Silla TOMMY

Color natural
59 x 57 x 75 cm.
Altura asiento: 44 cm.
Altura brazos: 59 cm.



Silla TOMMY O

59 x 57 x 75 cm.
Altura asiento: 44 cm.
Altura brazos: 59 cm.



Silla GALA
Teca, tapizado beige
46*52*82,5 cm.
Altura asiento: 48 cm.



Sillón ANTONI
Teca, tapizado beige
60*62*82,5 cm.
Altura asiento: 48 cm.
Altura brazo: 67 cm.



Silla OLAF
Color natural asiento negro
57*58*80 cm.
Altura asiento: 45 cm.



Silla OLAF
Color natural
57*58*80 cm.
Altura asiento: 45 cm.

GRUPO
muebles
INTERMOBEL



Silla OLAF
Color nogal oscuro asiento natural
57*58*80 cm.
Altura asiento: 45 cm.



Silla OLAF
Color negro/asiento natural
57*58*80 cm.
Altura asiento: 45 cm.



Butaca BALI Natural
71*76*73 cm.
Altura asiento: 39 cm.



Silla JAVA
Negro/Rattan natural
Altura asiento: 45 cm.
57*60*86 cm.



Silla JAVA
Natural/Rattan natural
Altura asiento: 45 cm.
57*60*86 cm.



Silla ICON
Natural/Rattan natural
Altura asiento: 45 cm.
46*67*80 cm.



Sillón ICON
Natural/Rattan natural
Altura asiento: 45 cm.
66*67*80 cm.

muebles
INTERMOBEL



Sillón ICON
Negro/Rattan natural
Altura asiento: 45 cm.
66*67*80 cm.



Silla ICON
Negro/Rattan natural
Altura asiento: 45 cm.
46*67*80 cm.



Silla BAYONA
Tap. 1 Beige (2 tonos)
Tap. 2 Gris (2 tonos)
55*61*87 cm.
Altura asiento: 47 cm.



Silla BORGONA
Tap. 1 Camel (2 tonos)
Tap. 2 Gris (1 tono)
47,5*55*82 cm.
Altura asiento: 48 cm.



Silla NANTES
55*61*88 cm.
Tap. 1 Beige (2 tonos)
Tap. 2 Gris (2 tonos)
Altura asiento: 45 cm.





Silla BRETAÑA

Tap. 1 Gris
Tap. 2 Mostaza
56*62*84 cm.
Altura asiento: 49 cm.
Altura brazo: 65 cm.



Silla NORMANDÍA

Tap. 1: Amarillo
Tap. 2: Gris
Altura Asiento: 48 cm.





Silla CASINO
Blanca / Patas de madera
53,5 x 47 x 85,5 cm.
Altura asiento: 47 cm.



Silla KENTIA
Blanca/patas de madera
49x54x83 cm.
Altura asiento: 47 cm.

Silla SUDOKU
Blanca
Patas de madera
53 x 46,5 x 82 cm.
Altura asiento: 46 cm.



Silla PICAS
Blanca / con cojín
Patas de madera
55 x 48 x 84 cm.
Altura asiento: 47 cm.





Silla JOKER
Blanca/patas de madera
55x49,5x90 cm.
Altura asiento: 47 cm.



Silla JULEPE
Color blanco
55 x 49,5 x 90 cm.
Altura asiento: 46 cm.

muebles
GRUPO **INTERMOBEL**



Silla KARAT
Blanca con cojín
Patas cromadas
55 x 48 x 84 cm.
Altura asiento: 49 cm.



Silla ESTUDIO
Blanca / Con cojín
Patas cromadas con ruedas
55 x 48 x 84 cm.
Altura asiento: 45/55 cm.



Sillón POKINO

Blanco
61,5 x 62,5 x 79,5 cm.
Altura asiento: 46 cm.
Altura brazos: 67 cm.



Sillón COMODÍN

Blanco
55,5 x 62 x 75 cm.
Altura asiento: 45 cm.
Altura brazos: 72 cm.

GRUPO MUEBLES
INTERMOBEL



Sillón DIAMANTE

Tapizado patchwork
Patas de madera
64 x 64 x 80 cm.
Altura asiento: 48 cm.
Altura brazos: 66,5 cm.



Sillón PINACLE

Blanco / Negro
Apilables
55,5 x 55 x 83,5 cm.
Altura asiento: 45 cm.
Altura brazos: 66,5 cm.



GRUPO
muebles
INTERMOBEL



Silla DOMINÓ

Transparente
Apilables
49 x 38,5 x 91 cm.
Altura asiento: 47,5 cm.



Sillón DOMINÓ

Transparente
Apilables
57 x 54 x 92,5 cm.
Altura asiento: 47,5 cm.
Altura brazos: 67 cm.



Silla CHELO
50 x 61 x 84 cm.
Altura asiento: 49 cm.

GRUPO **INTERMOBEL**



Butaca LOUVRE
Roble flemmish
64 x 67 x 96 cm
Altura asiento: 48 cm.
Altura brazo: 62 cm.



Butaca REIMS

Roble FLEMMISH
73 x 68 x 96 cm.
Altura asiento: 48 cm.
Altura brazo: 60 cm.



GRUPO **INTERMOBEL**



Butaca REIMS

Roble humo
73 x 68 x 96 cm.
Altura asiento: 48 cm.
Altura brazo: 60 cm.

Características

Extraordinaria selección de mesas de comedor que reflejan las nuevas tendencias con gran diseño y novedosos acabados.

Las estructuras son perfiles de acero laminado en frío y pintadas al horno en diferentes colores.

Las tapas en cristal, laminados cerámicos o tableros MDF con chapa de diferentes maderas, como bulinga keva, fresno,...

Las sillas presentan bonitos diseños con líneas sencillas y sólidas, fabricadas con estructura de madera y tapizadas en tela.

Characteristics

An outstanding selection of dining tables which reflect the latest trends with great designs and innovative finishes.

The structures are cold-laminated steel profiles, oven-painted in different colours.

The tabletops are made of glass, ceramic laminates or MDF boards with veneers in different woods, such as bulinga keva, ash...

The chairs come with pleasing designs and simple but solidly-made lines, manufactured with wooden structures and upholstered in fabric.

Lineamenti

Una straordinaria selezione di tavoli da pranzo che rispecchiano le nuove tendenze, caratterizzati da uno splendido design e da finiture innovative.

Le strutture sono costituite da profili in acciaio laminato a freddo e verniciate a forno in diversi colori.

I piani, invece, sono realizzati in vetro, in laminato o con pannelli MDF con un'impiallacciatura di diversi tipi di legno, come il bubinga, il frassino, ecc.

Le sedie dallo splendido design presentano linee semplici ma solide e sono realizzate con strutture in legno e foderate in tessuto.

Caracteristiques

Exceptionnelle sélection de tables à manger qui reflètent les nouvelles tendances avec un design de qualité et des finitions innovantes.

Les structures sont constituées de profils d'acier laminés à froid à la peinture cuite au four, en différentes couleurs.

Les revêtements en verre, en céramique ou en panneaux MDF avec placage de différents bois, tels que le bulinga keva, le frêne...

Arborant de beaux motifs et des lignes simples mais résistantes, les chaises sont fabriquées avec une structure en bois et recouvertes de tissu.



I7
COLECCIÓN
MESAS



● **Mesa comedor extensible MILETO**

Tapa cristal pintado "PIEDRA"
Pie roble macizo
Base acero inox.
180/220 x 90 x 76 cm.

● **Mesa comedor extensible MILETO**

Tapa cristal pintado "PIEDRA"
Pie roble macizo
Base acero inox.
180/220 x 90 x 76 cm.



GRUPO **INTERMOBEL**

Lámpara de techo 510
Ø36*25 cm



Mesa extensible DUMAS

Chapa de fresno
Base en acero
160/220 x 90 x 76 cm.

Lámpara de techo 506
Ø48*24cm

Mesa comedor ATHOS
200 x 100 x 75 cm.



Consola ATHOS
120 x 46 x 76 cm.



Mesa redonda WINDSOR fija
Ø 106 x 76 cm.



GRUPO
muebles
INTERMOBEL

Silla WINDSOR

44 x 48,5 x 91,4 cm.

Altura asiento: 44 cm.

ABIERTA

Mesa redonda extensible WINDSOR

Blanco y nogal
Ø 106 / 146 x 76 cm.

CERRADA

Mesa redonda extensible WINDSOR

Color nogal
Ø 106 / 146 x 76 cm.

muebles
INTERMOBEL

ABIERTA

Silla WINDSOR

44 x 48,5 x 91,4 cm.
Altura asiento: 44 cm.

Silla BALMORAL

Color nogal claro
49 x 49 x 88 cm.
Altura asiento: 47 cm.

Consola TRENTO
125 x 35,5 x 75 cm.



**Mesa centro
elevable TRENTO 130**
130 x 70 x 45/58 cm.



Lámpara de techo 510
Ø36*25 cm

Lámpara de techo 506
Ø48*24 cm.

Lámpara de techo 510
Ø36*25 cm

Mesa comedor MANDALAY
Tapa acacia - Patas acero inox.
160 x 90 x 76 cm.



Consola CANFRANC

Tapa tecla reciclada
Patas acero inox.
140*40*80 cm.

muebles
GRUPO
INTERMOBEL



Mesa centro ALTAMIRA

Tapa marmol BIDASUR
Patas acero inox.
130 x 70 x 40 cm.



CERRADA

Mesa comedor BUTTERFLY MOMBASA

Roble anticuario
180/250 x 100 x 78 cm

GRUPO **INTERMOBEL**



Mesa comedor extensible MOMBASA

Roble anticuario
160/240 x 100 x 78 cm

LAS EXTESIONES SE GUARDAN APARTE



Detalle sistema BUTTERFLY
con la extensión en el interior



GRUPO muebles
INTERMOBEL



ABIERTA



CERRADA

Mesa comedor SAMOA butterfly
160/220 * 95 *78 cm.



Silla SAMOA
48 x 55 x 100 cm
Altura asiento: 47 cm.

muebles
INTERMOBEL



CERRADA

Mesa QUEBEC extensible 180
180/220 x 100 x 78 cm
La extensión se guarda fuera de la mesa

Mesa QUEBEC butterfly 145
145/185 x 85 x 77 cm
La extensión se guarda dentro de la mesa



ABIERTA



Detalle sistema BUTTERFLY con la extensión en el interior



ABIERTA



Silla QUEBEC

49 x 56 x 97 cm
Altura asiento: 46 cm.



ABIERTA

Mesa comedor BONANZA extensible

Color blanco patinado

Madera vista de olmo reciclado

160/240 x 90 x 78 cm



GRUPO MUEBLES
INTERMOBEL



Mesa centro SAMOA

120 x 70 x 45 cm



Mesa rincón SAMOA
50 x 50 x 55 cm



Carro abatible MOMBASA
Roble anticuario
115 x 70 x 86 cm

muebles
GRUPO INTERMOBEL

Mesa centro MOMBASA

Roble anticuario
145 x 85 x 45 cm

120 x 70 x 45 cm





Mesa comedor redonda
Extensible **AMBIENTES**
Color vainilla.
120/160 x 120 x 78 cm.

Cerrada



Abierta



Silla **AMBIENTES**
Color vainilla.
54 x 53 x 102 cm.
Altura asiento: 46 cm.



DETALLE APERTURA



**Mesa centro
AMBIENTES 115**
Color vainilla.
115 x 70 x 50 cm.



Mesa centro NIZA 90
90 x 90 x 46 cm



Mesa rectangular SAVOY fija

Tapa blanca / Patas de madera
120 x 80 x 73 cm.





CERRADA

Mesa extensible SAVOY

Tapa blanca / Patas de madera
120/150 x 80 x 73 cm.

muebles
GRUPO **INTERMOBEL**



ABIERTA

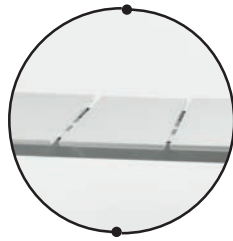

LA EXTENSIÓN SE GUARDA DENTRO DE LA MESA

Características

Las últimas tendencias en lámparas en acabado cobre lacado marcan el comienzo de una completa selección de lámparas de techo, mesa y pie, en diversos materiales como vidrio transparente, metal e incluso polipropileno.

Characteristics

On-trend lighting with a copper lacquer finish is just the start of an extensive collection of ceiling, table and floor lamps. The designs come in a variety of materials including clear glass, metal and polypropylene.

Lineamenti

Le ultime tendenze in lampade con finiture in rame laccato danno il via a una selezione completa di lampade da soffitto, da tavolo e da terra, in vari materiali quali vetro trasparente, metallo, ma anche polipropilene.

Caracteristiques

Les dernières tendances de lampes en cuivre laqué marquent le début d'une nouvelle ère de plafonniers, lampes de bureau et lampadaires. Divers matériaux sont disponibles tels que le verre transparent, le métal et le polypropylène.



18
COLECCIÓN
LÁMPARAS

Lámpara de mesa 825-A
Estructura metal, acabado latón
globo de cristal blanco
Casquillo E14 Ø20*25 cm.



Lámpara de mesa 825-B
Estructura metal, acabado latón,
globo de cristal blanco
Ø20*40 cm. Casquillo E14



Lámpara de mesa 825-C
Estructura metal, acabado latón
globo de cristal blanco
28*53 cm. Casquillo E14

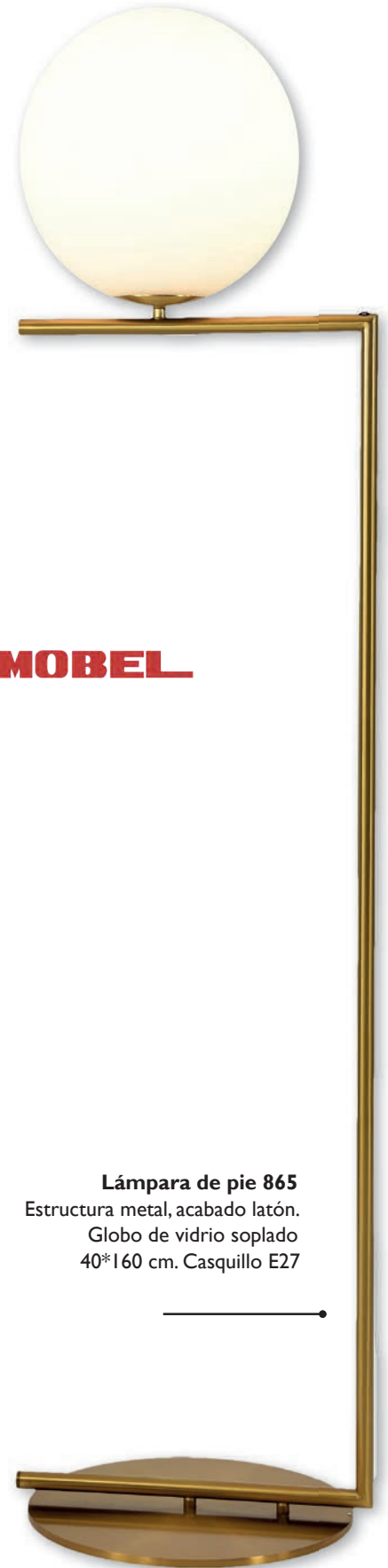

Lámpara de pie 865
Estructura metal, acabado latón.
Globo de vidrio soplado
40*160 cm. Casquillo E27

muebles
INTERMOBEL

Lámpara de pie 865-N
Estructura metal, acabado negro
Globo de vidrio soplado blanco
40*160 cm. Casquillo E27



Lámpara de mesa 825-B-N
Estructura metal, acabado negro
Globo de vidrio soplado blanco
20*40 cm. Casquillo E14



Lámpara de mesa 825-A-N
Estructura metal, acabado negro
Globo de vidrio soplado blanco
20*25 cm. Casquillo E14

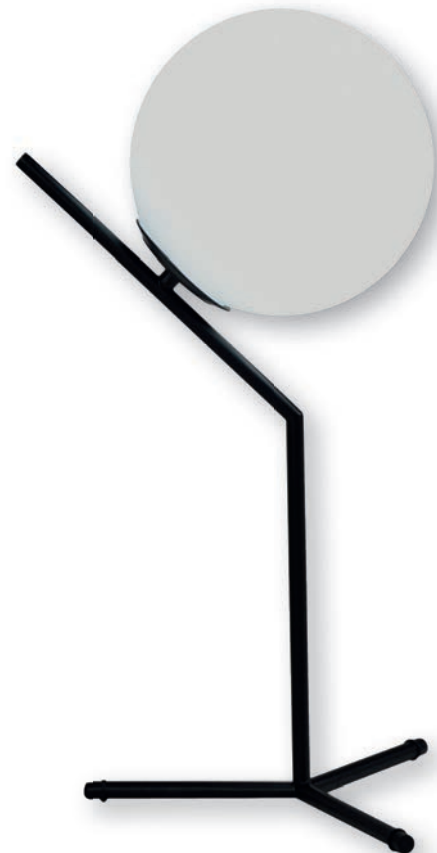

Lámpara de mesa 825-C-N
Estructura metal, acabado negro
Globo de vidrio soplado blanco
28*53 cm. Casquillo E14



Lámpara de mesa 732-B

Estructura metal y cobre
acabado negro y latón
Ajustable en altura
54*16*55 cm. Casquillo E27



Lámpara de mesa 732-C

Estructura metal y cobre
acabado negro y latón
Ajustable en altura
70*16,3*52 cm. Casquillo E27



Lámpara de mesa 716-B

Estructura metal blanco y
madera Tulipa algodón blanco
25*40 cm. Casquillo E27



Lámpara de mesa 83 I

Estructura metal, acabado
latón. Globo de cristal blanco
30*15*17,5 cm. Casquillo G9



Lámpara de mesa 826

Estructura marmol blanco y
metal acabado latón
Ø10*13 cm.

GRUPO
muebles
INTERMOBEL



Lámpara de mesa 1118-3

Estructura metal, acabado
latón 3 globos cristal opaco
30*60 cm. Casquillo G9



Lámpara de mesa 1105-5

Estructura metal, acabado
latón 5 globos cristal opaco
28*66 cm. Casquillo G9



Lámpara de mesa 943-B
Estructura metal acabado latón
Tulipa blanca 34*16*60 cm.
Casquillo E27



Lámpara de mesa 942-B
Estructura metal acabado plata
Tulipa blanca 38*20*54 cm.
Casquillo E27



Lámpara de mesa 708
Ø 38 x 57 cm.



Lámpara de mesa 43
Ø 32 x 58 cm.

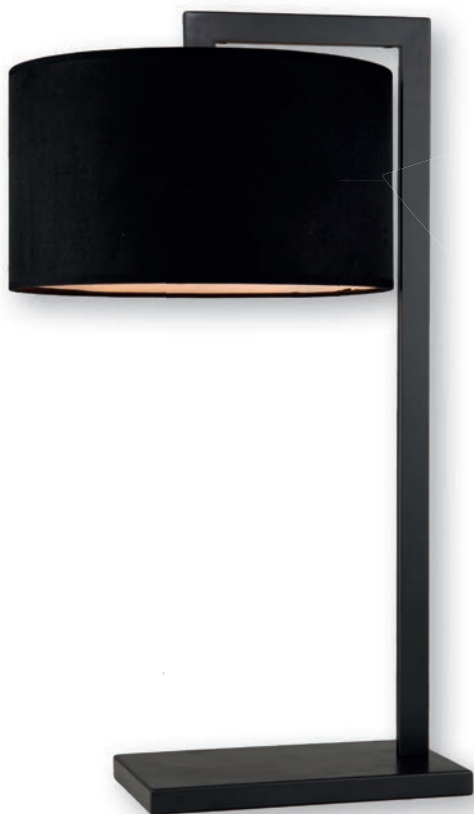

Lámpara de mesa 1242-N
Estructura metal, acabado negro
Pantalla de algodón negro
37*32*65 cm. Casquillo E27



Lámpara de mesa 1096
35 x 35 x 68 cm.



Lámpara de mesa 2059
Ø 18 x 52 cm.



Lámpara de mesa 216-C
COBRE
Ø 25 x 82 cm.



Lámpara de mesa
1065 grande
Ø 24 x 85 cm.



Lámpara de
mesa 2004
Ø 18 x 57 cm.



Lámpara de mesa 106-C
COBRE
Ø 18 x 52 cm.



Lámpara de mesa
2059-C
Ø 18 X 52 cm.

Lámpara de pie 997-4
Estructura metal, acabado latón
Globos de vidrio de color
Ø25*153 cm. Casquillo G9



GRUPO muebles
INTERMOBEL

Lámpara de mesa 997-2
Estructura metal, acabado latón
Globos de vidrio de color
18,5*18*63 cm. Casquillo E14



Lámpara de mesa 997-1
Estructura metal, acabado latón
Globo de vidrio de color
18,5*18*48,5 cm. Casquillo E14





Lámpara de pie 03
3 focos
Ø 35 x 120 x 180 cm.



Lámpara de pie 1242-N
Estructura metal, acabado negro
Pantalla de algodón negro
47*42*165 cm. Casquillo E27

Lámpara de pie 01
Ø 45 x 230 x 220 cm.

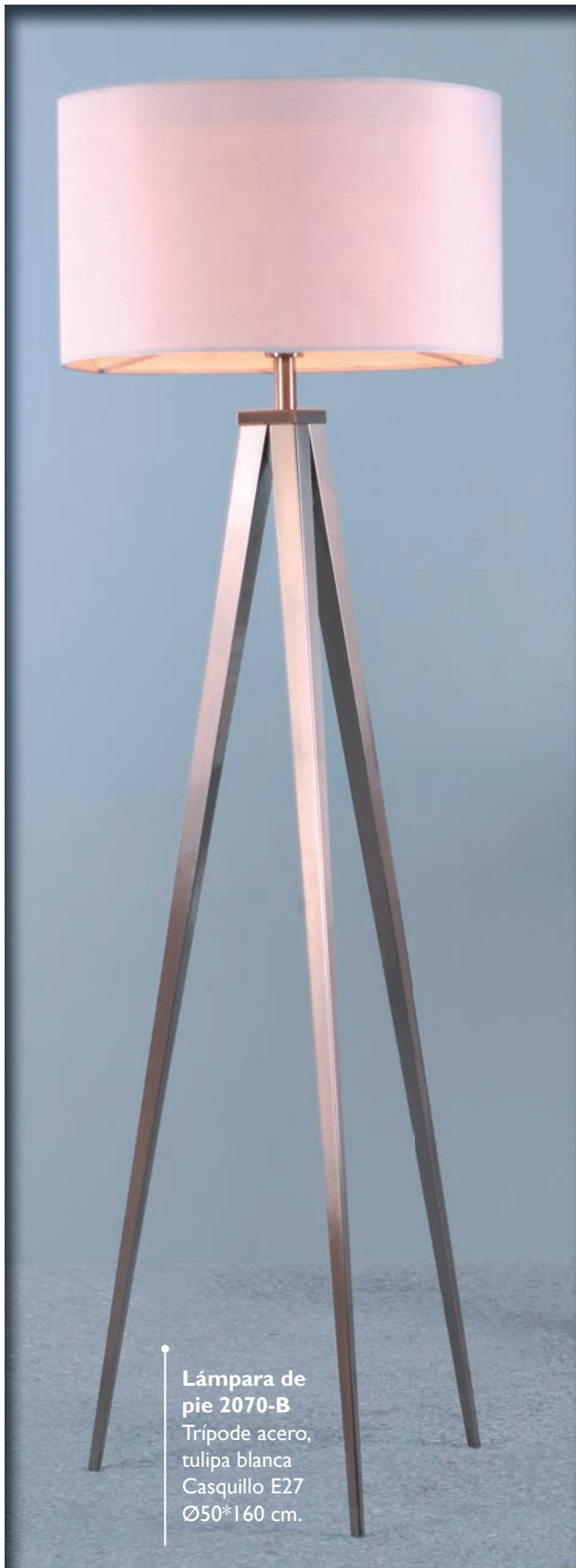

Lámpara de pie 2070-B
Trípode acero,
tulipa blanca
Casquillo E27
Ø50*160 cm.



Lámpara de pie 732
Metal acabado negro y latón
Casquillo E27
65*50*170/200 cm.



Lámpara de pie 1105-5
Estructura metal, acabado
latón 5 globos cristal opaco
Base de mármol Casquillo E14
35*170 cm.

GRUPO muebles
INTERMOBEL

Lámpara de techo 448B
Ø 30 x 28 cm.



Lámpara de techo 500-G
Ø 40 cm.

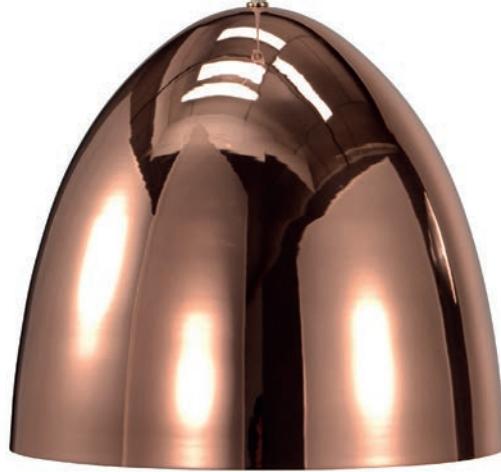

Lámpara de techo 448C
Ø 33,5 X 24 cm.

Lámpara de techo 449-P
Ø 25 cm.



Lámpara de techo 295-P
Ø 30 cm.



Lámpara de techo 449-G
Ø 35 cm.

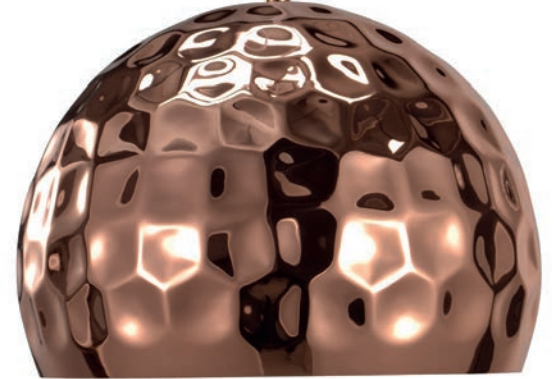

Lámpara de techo 510
Ø 36 x 25 cm.



Lámpara de techo 506
Ø 48 cm. x 24 cm.



Lámpara de techo 232
Metal. Mediana 44x50 cm.

Pequeña 33x38 cm.





Lámpara de techo 910-E
Acabado color latón
36*32*60 cm.
LED Luz cálida



Lámpara de techo 910-D
Acabado color latón
42*42*60 cm.
LED Luz cálida



Lámpara de techo 910-F
Acabado color latón
36*32*60 cm.
LED Luz cálida

muebles
GRUPO **INTERMOBEL**



Lámpara de techo 911-60
Acabado color latón
Cuentas de cristal
Ø60 cm.
LED Luz cálida



Lámpara de techo 911-80
Acabado color latón
Cuentas de cristal
Ø80 cm.
LED Luz cálida



Lámpara de techo I 100-G
Acabado color níquel
60*30*30 cm.
LED Luz cálida



Lámpara de techo I 100-M
Acabado color níquel
40*40*40 cm.
LED Luz cálida

muebles
INTERMOBEL



Lámpara de techo I 100-P
Acabado color níquel
40*20*20 cm.
LED Luz cálida



Lámpara de techo 910-A
Acabado color níquel
28*28*36 cm.
LED Luz cálida



Lámpara de techo 910-C
Acabado color níquel
26*26*42 cm.
LED Luz cálida



GRUPO
MUEBLES
INTERMOBEL

**PEÑA
VARGAS**
DESDE 1931

Carretera M-225, K 2,200, 28890 Loeches (Madrid)
Tel. 91 675 60 33 - Fax 91 676 66 12 - e-mail: ventas@pvargas.com
www.mobimundo.es - www.pvargas.com