

SISTEMAS DE ALMACENAJE  
Racking systems • Systèmes de rangement

2021

Julio • July • Juillet

CATÁLOGO

estanterías  
**JOMASI**



## TRADICIÓN FAMILIAR, MÁS DE TRES GENERACIONES

**Estanterías Jomasi S.L.**, una empresa con una gran tradición familiar, en la que generación tras generación hemos ido creciendo e innovando. Nuestra familia lleva **más de 50 años** dedicada al diseño, fabricación y distribución de sistemas de almacenaje, mobiliario para vestuarios y colectividades y equipamiento comercial. En el año 1999, basados en nuestra amplia experiencia en el sector, decidimos volver a empezar de cero en el término municipal de **Cuarte de Huerva** (Zaragoza).

El éxito de nuestra empresa es **el gran equipo humano que la compone**, la inversión en medios productivos de última generación y la apuesta continua en I+D+i. La suma de estos factores nos ha permitido la entrada en nuevos mercados internacionales : Bélgica, Colombia, Etiopía, Francia, Holanda, Italia, Luxemburgo, Portugal y Senegal.

Desde nuestros inicios, siempre hemos dado **prioridad a la calidad**. Desde el año 2006, el Sistema de Gestión de la calidad que avala todos nuestros procesos productivos está certificado por Bureau Veritas Certification.

Cada vez más concienciados con el cuidado de nuestro planeta, Estanterías Jomasi aplica su **Sistema de Gestión Medioambiental** expedido por Bureau Veritas Certification que involucra a todos los departamentos que constituyen la sociedad mercantil. En nuestro **compromiso por un mundo más sostenible**, hemos decidido apostar por la energías renovables y nuestra última inversión ha sido en energía verde, tras la instalación placas fotovoltaicas que generan más de la mitad de la energía que consumimos.

Por todas estas razones, nos apasiona nuestro trabajo y nos reinventamos todos los días para adaptarnos a las necesidades de nuestros clientes.

## A COMPANY WITH A LONG FAMILIAR TRADITION, MORE THAN THREE GENERATIONS

**Estanterías Jomasi S.L.** is a Spanish company with a long familiar tradition in which generation after generation, we have been growing and innovating. For **more than 50 years**, our family has been dedicated to the manufacture and distribution of storage systems, furniture for changing rooms and communities and commercial equipment. In the year 1999, based on our wide experience in this sector, we decided to start from zero in **Cuarte de Huerva**, Zaragoza.

The real success of our company is **the human team that composes it**. Apart from the investment in productive means of the last generation and the ongoing commitment towards R & D & I. The combination of these factors has allowed us to enter new markets like Belgium, Colombia, Ethiopia, France, Holland, Italy, Luxembourg, Portugal and Senegal.

From Jomasi´s beginnings, we have **always prioritized the quality of our products**. Since 2006, the Quality Management System, granted by Bureau Veritas Certification, guarantees all of our productive proceses.

We are also a company that cares for the environment. For this reason, Estanterías Jomasi applies in all of the departments of the company the Environmental Management System certified by Bureau Veritas Certification. In accordance with **our commitment to a more sustainable world**, we have decided to invest in renewable energies. And our latest investment has been in green energy after installing photovoltaic panels which generate more than a half of the energy our factory consumes.

For all of these reasons, we love our work and we reinvent ourselves every day with the purpose of adapting to the needs of our clients.

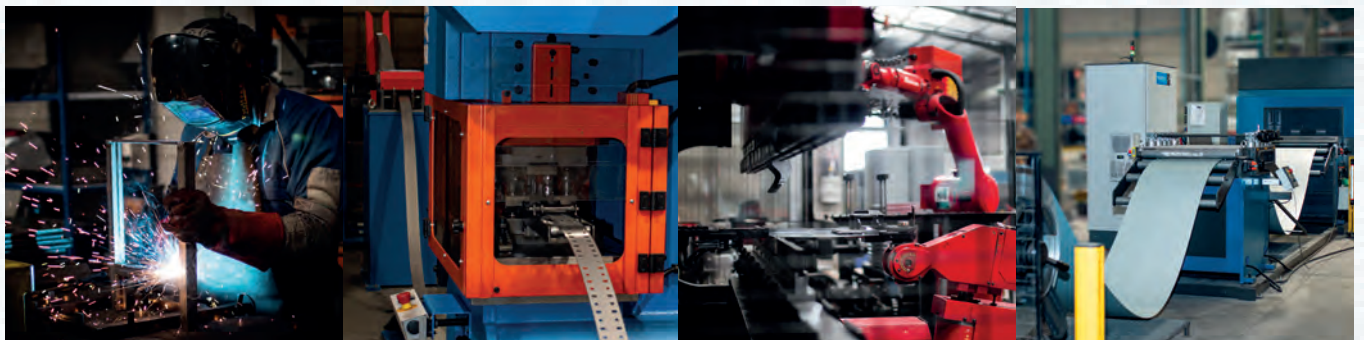

+34 976 504 103

atencionalcliente@estanteriasjomasi.com

WWW

[www.estanteriasjomasi.com](http://www.estanteriasjomasi.com)

## TRADITION FAMILIALE, PLUS DE TROIS GENERATIONS

**Rayonnages Jomasi S.L.**, est une entreprise ayant une grande tradition familiale, où génération après génération nous avons grandi et innové. Notre famille est consacrée depuis **plus de 50 ans** à la conception, la fabrication et la distribution de systèmes de rangement, de mobilier pour vestiaires, collectivités et d'équipements commerciaux. En 1999, sur la base de notre vaste expérience dans ce secteur, nous avons décidé de tout reprendre à zéro à la municipalité de **Cuarde de Huerva** (Saragosse).

Le succès de notre entreprise est **la grande équipe humaine qui la compose**, l'investissement dans des moyens de production de dernière génération et le déploiement continu d'efforts dans la recherche, le développement et l'innovation.

La somme de ces facteurs nous a permis de nous introduire sur de nouveaux marchés internationaux, la Belgique, la Colombie, l'Éthiopie, la France, les Pays-Bas, l'Italie, le Luxembourg, le Portugal et le Sénégal.

Depuis nos origines, nous avons toujours donné **la priorité absolue à la qualité**. Depuis 2006, le système de gestion en matière de qualité qui soutient tous nos processus de production a reçu le label de certification de bureau Veritas.

De plus en plus consciente de la préservation de notre planète, Rayonnages Jomasi applique ses systèmes de gestion environnementale certifiés par le bureau Veritas et fait intervenir tous les services qui composent notre société commerciale. Dans le cadre de **notre engagement pour un monde plus durable**, nous avons décidé d'opter pour les énergies renouvelables et nos derniers investissements ont été réalisés dans l'énergie verte, après l'installation de panneaux photovoltaïques, qui génèrent plus de la moitié de l'énergie que nous consommons.

Pour toutes ces raisons, nous sommes tous passionnés par notre travail et nous nous réinventons jour après jour pour nous adapter aux

**Calidad**  
quality / qualité



Estanterías Jomasi, S.L. diseña, fabrica, instala y comercializa estanterías metálicas, armarios para vestuario y colectividades y equipamiento comercial certificado por Bureau Veritas Certification, mediante su Sistema de Gestión de la Calidad UNE EN ISO 9001:00

Estanterías Jomasi, S.L. designs, manufactures, installs and markets, metal shelving and metal cabinets for locker rooms and community buildings and commercial equipment certified by Bureau Veritas Certification via its Quality Management System UNE EN ISO 9001:00

Estanterías Jomasi, S.L. conçoit, fabrique, installe et commercialise des rayonnages métalliques, des armoires de vestiaires et pour les collectivités et équipement commercial et est certifié par Bureau Veritas Certification, grâce à son Système de Gestion de la Qualité UNE EN ISO 9001:00.



**Medio ambiente**  
environment / environnement

Concienciados con el medio ambiente, aplicamos en todos nuestros procesos, tanto organizativos como productivos, el Sistema de Gestión Medioambiental de acuerdo con la norma UNE EN ISO 14001:04

We are very much aware of the need to protect our environment, and for this reason, in all of our productive and organizational processes we apply the UNE EN ISO 14001:04 Environmental Management System.

Sensibilisés à l'environnement, nous appliquons dans tous nos processus, d'organisation comme de production, le Système de Gestion Environnementale conforme à la norme UNE EN ISO 14001:04.

# 8-17

Ángulo ranurado  
Slotted angle shelving  
Cornière perforée

Sistema de almacenaje muy versátil y económico.  
A versatile and economical storage system option.  
L'option la plus économique.



Con tornillos  
With bolts  
Avec vis



125kg  
Peso por balda  
Weight per shelf  
Poids par tablette



# 18-27

J200 Sistema de encastre  
J200 Socket system  
J200 Cornière clipsable

Estantería Metálica sin tornillos muy fácil de montar.  
Metal shelving without screws very easy to assemble.  
Etagère métallique montage très facile.



275kg  
Peso por balda  
Weight per shelf  
Poids par tablette



Sin tornillos  
Without bolts  
Sans vis



Martillo nylon  
Nylon hammer  
Marteau nylon



# 28-45

J600 Sistema de encastre  
J600 Socket system  
J600 Cornière clipsable

Ideal para talleres y almacenes  
Ideal for workshops and warehouses.  
Parfait pour magasin, atelier, entrepôt ou garage.



600kg  
Peso por balda  
Weight per shelf  
Poids par tablette



Sin tornillos  
Without bolts  
Sans vis



Martillo nylon  
Nylon hammer  
Marteau nylon



# 36-45

Bancos de trabajo  
Work benches  
Établissements de travail



# 46-51

Media Carga  
Heavy-Duty Racking  
Charges Mi-lourd

Estantería picking de gran capacidad diseñada para una carga de forma manual.

High capacity picking rack designed for a manual charge.

Rayonnage Picking haute capacité conçu pour une charge manuelle.



975kg  
Peso por balda  
Weight per shelf  
Poids par tablette

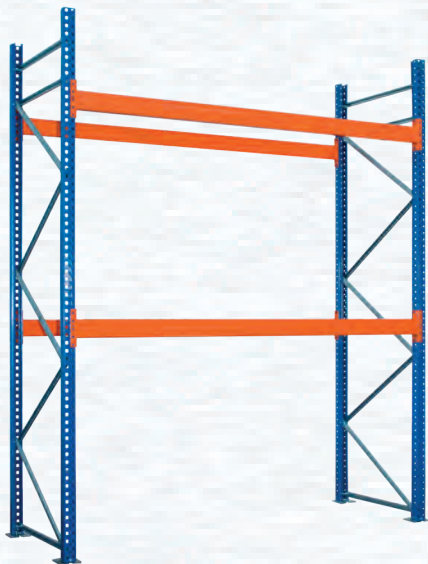

# 52-57

Paletización Convencional  
Pallet Racking  
Rack à palette

La solución más rentable y flexible para el almacenaje de productos paletizados.

The most economical and flexible solution for the storage of palletized products.

La solution la plus rentable et la plus flexible pour le stockage de produits palettisés.



Peso por balda  
Weight per shelf  
Poids par tablette

## Leyenda de símbolos / Symbol legend / Légende de symboles

**L**

**Longitud**

Length  
Longueur

**P**

**Profundidad**

Depth  
Profondeur

**H**

**Altura**

Height  
Hauteur

**A**

**Ancho**

Width  
Largueur

**Medidas mm / Measurements mm / Mesures mm**

**Peso kg / Weight kg / poids kg**

**Volumen m3 / Volumen m3 / volume m3**

## Características / Characteristics / Caracteristiques



**Con tornillos**

With bolts  
Avec vis



**Tiempo de montaje**

Assembly time  
Temps de montage



**Precaución**

Caution  
Prudence



**Sin tornillos**

Without screws  
Sans vis



**Pintado en Epoxi Poliester**

Painted in epoxy polyester  
Peinture en epoxi polyester



**Uso de guantes**

Use gloves  
Port de gants

**kg**



**Peso por balda**

Weight per shelf  
Poids par tablette



**Martillo nylon**

Nylon hammer  
Marteau nylon

GRUP m u e b l e s  
**INTERMOBEL**

estanterías  
**JOMASI**

# Ángulo ranurado / Slotted angle shelving / Rayonnage à visser

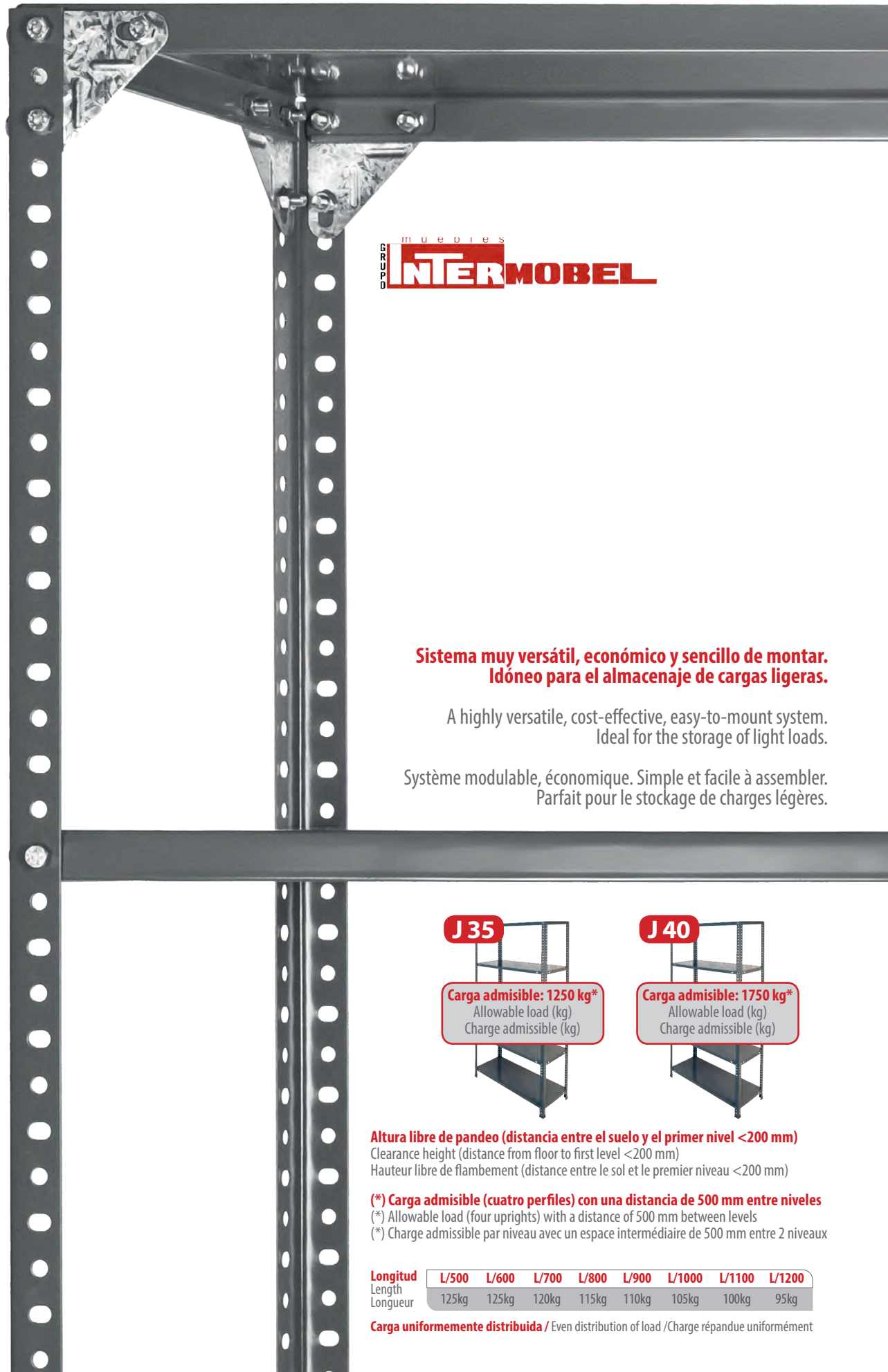

GRUPO muebles  
**INTERMOBEL**

**Sistema muy versátil, económico y sencillo de montar.  
Idóneo para el almacenaje de cargas ligeras.**

A highly versatile, cost-effective, easy-to-mount system.  
Ideal for the storage of light loads.

Système modulable, économique. Simple et facile à assembler.  
Parfait pour le stockage de charges légères.



**Altura libre de pandeo (distancia entre el suelo y el primer nivel <200 mm)**

Clearance height (distance from floor to first level <200 mm)

Hauteur libre de flambement (distance entre le sol et le premier niveau <200 mm)

**(\*) Carga admisible (cuatro perfiles) con una distancia de 500 mm entre niveles**

(\*) Allowable load (four uprights) with a distance of 500 mm between levels

(\*) Charge admissible par niveau avec un espace intermédiaire de 500 mm entre 2 niveaux

Longitud	L/500	L/600	L/700	L/800	L/900	L/1000	L/1100	L/1200
Length	125kg	125kg	120kg	115kg	110kg	105kg	100kg	95kg
Longueur								

**Carga uniformemente distribuida / Even distribution of load / Charge répartue uniformément**



**Perfil** / Upright / Montant



**Balda** / Shelf / Tablette



**Tornillo** / Bolt / Vis

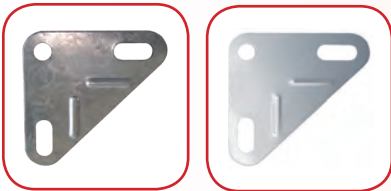

**Escuadra**  
Corner piece  
Équerre



**Base de plástico**  
Plastic foot  
Pied plastique



**Contenedor delantero**  
Front band  
Traverse avant conteneur



**Contenedor trasero**  
Back band  
Traverse arrière conteneur



**Divisor de contenedor**  
Band divider  
Séparateur de conteneur

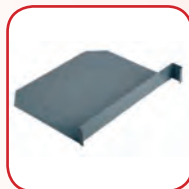

**Divisor de pestaña**  
Wall divider  
Séparateur onglet



**Cajón** / Bin / Tiroir

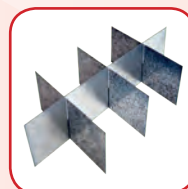

**Divisor cajón**  
Bin divider  
Séparateur tiroir



**Refuerzo balda**  
Shelf stiffeners  
Renfort tablette



**Chapa frontal**  
Front plate / Tôle frontale

**Chapa lateral**  
Side plate / Tôle latérale

muebles  
**INTERMOBEL**

# Ángulo ranurado / Slotted angle shelving / Rayonnage à visser

J/35



J/40

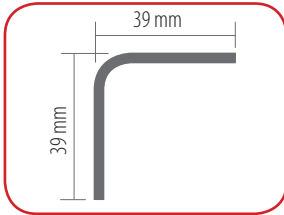
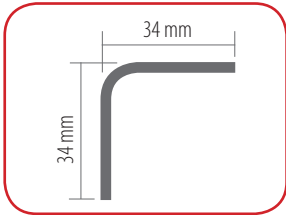

## Perfiles / Uprights / Montants

Artículo L Item L Article L	Referencia Reference Référence	Peso kg Weight kg Poids kg	Uds. paquete Units package Unités par paquet
J/35 de 2000	99013520	1,41	10
J/35 de 2500	99013525	1,76	10
J/35 de 3000	99013530	2,11	10

## Perfiles / Uprights / Montants

Artículo L Item L Article L	Referencia Reference Référence	Peso kg Weight kg Poids kg	Uds. paquete Units package Unités par paquet
J/40 de 2000	99014020	1,76	10
J/40 de 2500	99014025	2,20	10
J/40 de 3000	99014030	2,64	10

RAL 7046 Gris / Grey / Gris

RAL 7046 Gris / Grey / Gris

## Baldas / Shelves / Tablettes

Artículo LxP Item LxD Article LxP	Referencia Reference Référence	Peso kg Weight kg Poids kg	Uds. paquete Units package Unités par paquet
500 x 300	99010503	1,23	6
500 x 400	99010504	1,54	6
600 x 300	99010603	1,45	6
600 x 400	99010604	1,81	6
600 x 500	99010605	2,48	6
600 x 600	99010606	2,90	6
700 x 300	99010703	1,67	6
700 x 400	99010704	2,09	6
700 x 500	99010705	2,86	6
700 x 600	99010706	3,33	6
800 x 300	99010803	1,90	6
800 x 400	99010804	2,36	6
800 x 500	99010805	3,24	6
800 x 600	99010806	3,77	6
800 x 700	99010807	4,31	6
900 x 300	99010903	2,12	6
900 x 400	99010904	2,64	6
900 x 500	99010905	3,61	6
900 x 600	99010906	4,21	6
900 x 700	99010907	4,81	6
1000 x 300	99011003	2,34	6
1000 x 400	99011004	2,91	6
1000 x 500	99011005	3,99	6
1000 x 600	99011006	4,65	6
1000 x 700	99011007	5,31	6

RAL 7046 Gris / Grey / Gris

## Base sencilla / Single foot / Pied plastique

Artículo Item Article	Referencia Reference Référence	Peso kg Weight kg Poids kg	Unidades envase Units packs Unités par emballage
Base sencilla 35 Gris / Single foot Grey / Pied plastique Gris	99010011	0,04	Blister 4 / Blister pack / Blister
Base sencilla 40 Gris / Single foot Grey / Pied plastique Gris	99010013	0,04	Blister 4 / Blister pack / Blister
Base sencilla 35 Gris / Single foot Grey / Pied plastique Gris	99010015	0,65	Caja 100 / Box / Boîte
Base sencilla 40 Gris / Single foot Grey / Pied plastique Gris	99010017	0,67	Caja 100 / Box / Boîte
Base sencilla 35 Gris / Single foot Grey / Pied plastique Gris	99010019	9,75	Saco 1500 / Bag / Sac
Base sencilla 40 Gris / Single foot Grey / Pied plastique Gris	99010021	10,09	Saco 1500 / Bag / Sac



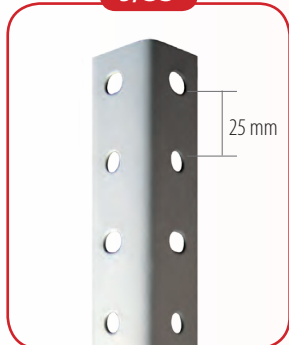
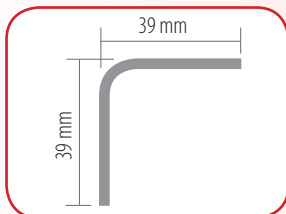
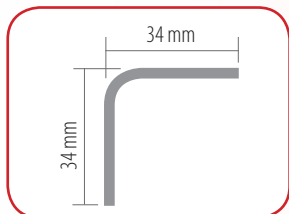
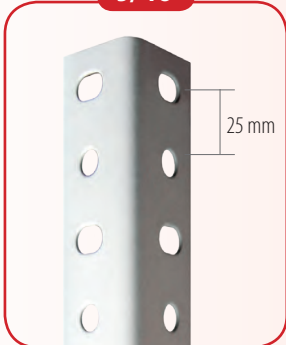

**J/35****J/40****Perfiles / Uprights / Montants**

Artículo L Item L Article L	Referencia Reference Référence	Peso kg Weight kg Poids kg	Uds. paquete Units package Unités par paquet
J/35 de 2000	99023520	1,41	10
J/35 de 2500	99023525	1,76	10
J/35 de 3000	99023530	2,11	10

RAL 9003 Blanco / White / Blanc

**Perfiles / Uprights / Montants**

Artículo L Item L Article L	Referencia Reference Référence	Peso kg Weight kg Poids kg	Uds. paquete Units package Unités par paquet
J/40 de 2000	99024020	1,76	10
J/40 de 2500	99024025	2,20	10
J/40 de 3000	99024030	2,64	10

RAL 9003 Blanco / White / Blanc

**Baldas / Shelves / Tablettes**

Artículo LxP Item LxD Article LxP	Referencia Reference Référence	Peso kg Weight kg Poids kg	Uds. paquete Units package Unités par paquet
600 x 300	99020603	1,45	6
600 x 400	99020604	1,81	6
600 x 500	99020605	2,48	6
600 x 600	99020606	2,90	6
700 x 300	99020703	1,67	6
700 x 400	99020704	2,09	6
700 x 500	99020705	2,86	6
700 x 600	99020706	3,33	6
800 x 300	99020803	1,90	6
800 x 400	99020804	2,36	6
800 x 500	99020805	3,24	6
800 x 600	99020806	3,77	6
900 x 300	99020903	2,12	6
900 x 400	99020904	2,64	6
900 x 500	99020905	3,61	6
900 x 600	99020906	4,21	6
1000 x 300	99021003	2,34	6
1000 x 400	99021004	2,91	6
1000 x 500	99021005	3,99	6
1000 x 600	99021006	4,65	6

RAL 9003 Blanco / White / Blanc

**Base sencilla / Single foot / Pied plastique**

Artículo Item Article	Referencia Reference Référence	Peso kg Weight kg Poids kg	Uds. envase Units packs Unités par emballage
Base sencilla 35 Blanca / Single foot White / Pied plastique Blanc	99010012	0,04	Blister 4 / Blister pack / Blister
Base sencilla 40 Blanca / Single foot White / Pied plastique Blanc	99010014	0,04	Blister 4 / Blister pack / Blister
Base sencilla 35 Blanca / Single foot White / Pied plastique Blanc	99010016	0,65	Caja 100 / Box / Boîte
Base sencilla 40 Blanca / Single foot White / Pied plastique Blanc	99010018	0,67	Caja 100 / Box / Boîte

 muebles  
**INTERMOBEL**

# Ángulo ranurado / Slotted angle shelving / Rayonnage à visser

J/35

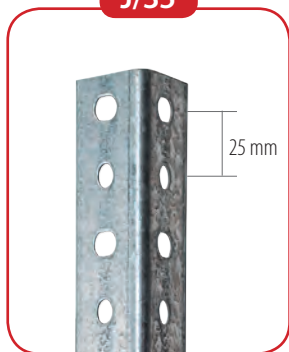

J/40

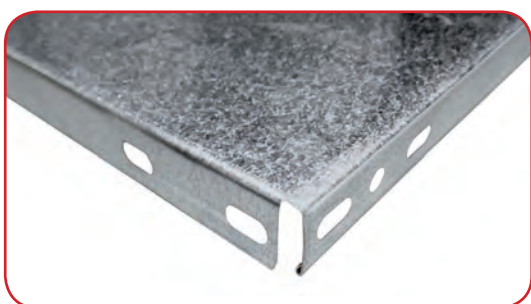
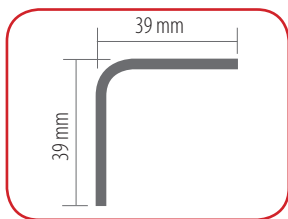
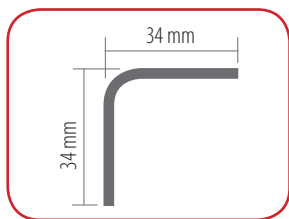
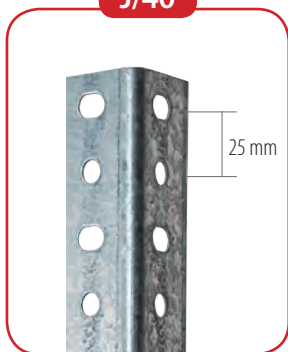

## Perfiles / Uprights / Montants

Artículo L Item L Article L	Referencia Reference Référence	Peso kg Weight kg Poids kg	Uds. paquete Units package Unités par paquet
J/35 de 2000	99093520	1,41	10
J/35 de 2500	99093525	1,76	10
J/35 de 3000	99093530	2,11	10

Galvanizado / galvanized / galvanisée

## Perfiles / Uprights / Montants

Artículo L Item L Article L	Referencia Reference Référence	Peso kg Weight kg Poids kg	Uds. paquete Units package Unités par paquet
J/40 de 2000	99094020	1,76	10
J/40 de 2500	99094025	2,20	10
J/40 de 3000	99094030	2,64	10

Galvanizado / galvanized / galvanisée

Corte a medida perfil: 0,35 €/neto / Upright cut-to size: 0.35 €/net / Coupe sur mesure profilé: 0,35 €/net

## Baldas / Shelves / Tablettes

Artículo LxP Item LxD Article LxP	Referencia Reference Référence	Peso kg Weight kg Poids kg	Uds. paquete Units package Unités paquet
800 x 300	99090803	1,90	6
800 x 400	99090804	2,36	6
800 x 500	99090805	3,24	6
800 x 600	99090806	3,77	6
900 x 300	99090903	2,12	6
900 x 400	99090904	2,64	6
900 x 500	99090905	3,61	6
900 x 600	99090906	4,21	6
1000 x 300	99091003	2,34	6
1000 x 400	99091004	2,91	6
1000 x 500	99091005	3,99	6
1000 x 600	99091006	4,65	6
1100 x 300	99091103	2,92	6
1100 x 400	99091104	3,65	6
1100 x 500	99091105	4,37	6
1100 x 600	99091106	5,09	6
1200 x 300	99091203	3,17	6
1200 x 400	99091204	3,96	6
1200 x 500	99091205	4,75	6
1200 x 600	99091206	5,53	6

Galvanizado / galvanized / galvanisée

GRUPO muebles  
**INTERMOBEL**

## Tornillos / Bolts / Boulons

Artículo Item Article	Referencia Reference Référence	Peso kg Weight kg Poids kg	Uds. envase Units pack Unités de l'emballage
Tornillo M8 x 16 ZC M8 x 16 ZC Bolt Boulon M8 x 16 ZC	99010001	0,59	Blister 40 40 Blister pack Blister 40
Tornillo M8 x 16 ZC M8 x 16 ZC Bolt Boulon M8 x 16 ZC	99010003	2,95	Caja 200 200 Box Boîte 200

**Escuadra galvanizada / Galvanized corner piece / Équerre galvanisée**

Artículo Item Article	Referencia Reference Référence	Peso kg Weight kg Poids kg	Uds. envase Units pack Unités par emballage
Escuadra galvanizada Galvanized corner piece Équerre galvanisée	99090006	0,20	Blister 8 8 Blister pack Blister 8
Escuadra galvanizada Galvanized corner piece Équerre galvanisée	99090007	2,70	Caja 100 100 Box Boîte 100
Escuadra galvanizada Galvanized corner piece Équerre galvanisée	99090009	30,00	Saco 1200 1200 Bag Sac 1200

Galvanizado / galvanized / galvanisée

**Escuadra blanca / White corner piece / Équerre blanc**

Artículo Item Article	Referencia Reference Référence	Peso kg Weight kg Poids kg	Uds. envase Units pack Unités de l'emballage
Escuadra blanca White corner piece Équerre blanc	99020006	0,20	Blister 8 8 Blister pack Blister 8
Escuadra blanca White corner piece Équerre blanc	99020007	2,70	Caja 100 100 Box Boîte 100

RAL 9003 Blanco / White / Blanc

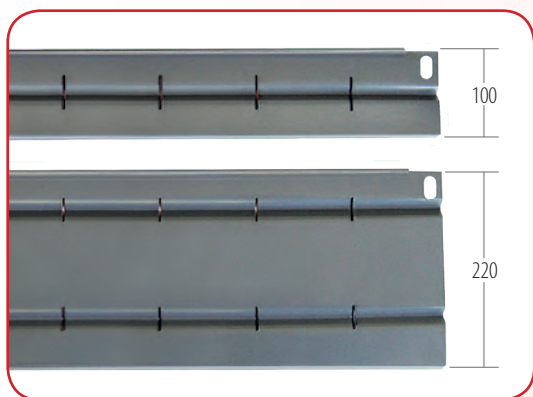
**Contenedores / Bands / Conteneur**

Artículo Item Article	Referencia Reference Référence	Peso kg Weight kg Poids kg	Uds. paquete Units package Unités par paquet
Delantero 600 / Front / Avant	99010042	0,43	10
Delantero 700 / Front / Avant	90010043	0,50	10
Delantero 800 / Front / Avant	99010044	0,57	10
Delantero 900 / Front / Avant	99010045	0,65	10
Delantero 1000 / Front / Avant	99010046	0,72	10
Trasero 600 / Back / Arrière	99010052	0,80	10
Trasero 700 / Back / Arrière	90010053	0,94	10
Trasero 800 / Back / Arrière	99010054	1,08	10
Trasero 900 / Back / Arrière	99010055	1,21	10
Trasero 1000 / Back / Arrière	99010056	1,35	10

RAL 7046 Gris / Grey / Gris

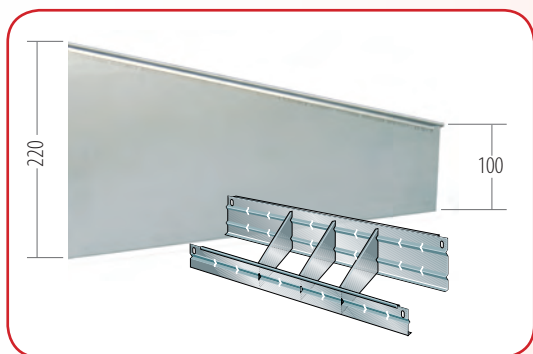
muebles  
**INTERMOBEL****Divisores de contenedor / Band dividers / Séparateurs de conteneur**

Artículo Item Article	Referencia Reference Référence	Peso kg Weight kg Poids kg	Uds. paquete Units package Unités par paquet
Divisor 300 / Divider / Séparateur	99090063	0,27	20
Divisor 400 / Divider / Séparateur	99090064	0,36	20
Divisor 500 / Divider / Séparateur	99090065	0,45	20
Divisor 600 / Divider / Séparateur	99090066	0,54	20

Galvanizado / galvanized / galvanisée

# Ángulo ranurado / Slotted angle shelving / Rayonnage à visser

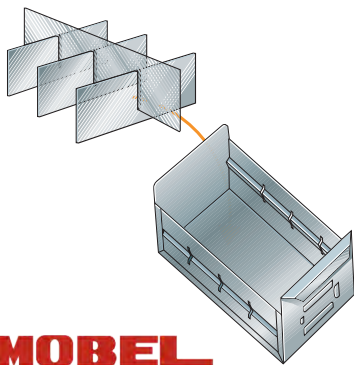
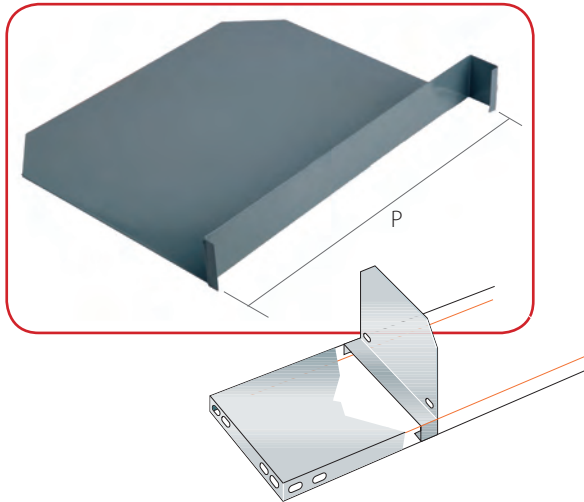

## Divisores de pestaña / Wall dividers / Séparateurs d'onglet

Artículo PxH Item PxH Article PxH	Referencia Reference Référence	Peso kg Weight kg Poids kg	Uds. paquete Units package Unités par paquet
Divisor 300 x 250H Divider / Séparateur	99010073	0,57	1
Divisor 400 x 250H Divider / Séparateur	99010074	0,75	1
Divisor 500 x 250H Divider / Séparateur	99010075	0,93	1
Divisor 600 x 250H Divider / Séparateur	99010076	1,11	1

RAL 7046 Gris / Grey / Gris

## Cajones / Bins / Tiroirs

Artículo PxA Item PxA Article PxA	Referencia Reference Référence	Peso kg Weight kg Poids kg	Uds. paquete Units package Unités par paquet
C/300 x 200	99010083	0,87	8
C/300 x 270	99010084	1,06	6
C/400 x 200	99010085	1,10	8
C/400 x 270	99010086	1,32	6
C/500 x 200	99010087	1,32	8
C/500 x 270	99010088	1,58	6

RAL 7046 Gris / Grey / Gris

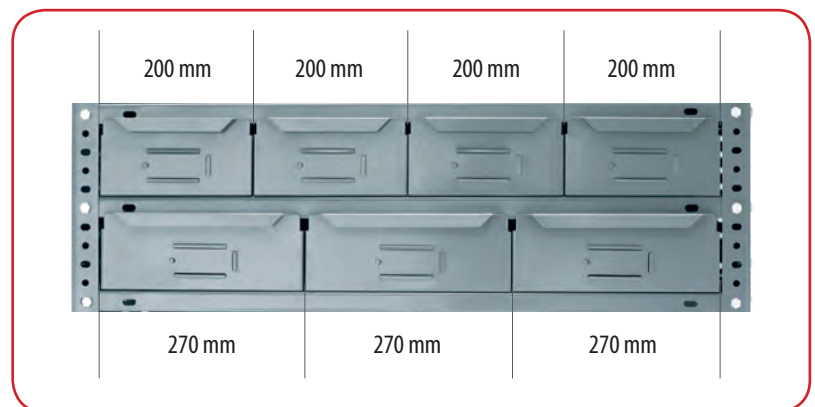

## Divisores de cajón / Bin dividers / Séparateurs tiroir

Artículo L Item L Article L	Referencia Reference Référence	Peso kg Weight kg Poids kg	Uds. paquete Units package Unités par paquet
Transversal 200 Width-wise / Transversal	99090091	0,08	---
Transversal 270 Width-wise / Transversal	99090092	0,11	---
Longitudinal 300 Depth-wise / Longitudinal	99090093	0,11	---
Longitudinal 400 Depth-wise / Longitudinal	99090094	0,15	---
Longitudinal 500 Depth-wise / Longitudinal	99090095	0,19	---

Galvanizado / galvanized / galvanisée

muebles  
**INTERMOBEL**

**Refuerzos para baldas / Shelf stiffeners / Renforts tablettes**

Artículo L Item L Article L	Referencia Reference Référence	Peso kg Weight kg Poids kg	Uds. paquete Units package Unités par paquet
R. Soldado/ 800 Welded stiffener / R.Soudé	99010104	---	---
R. Soldado 900 Welded stiffener / R.Soudé	99010105	---	---
R. Soldado 1000 Welded stiffener / R.Soudé	99010106	---	---
R. Atornillado 600 Bolted stiffener / R.Vissé	99010112	0,35	10
R. Atornillado 700 Bolted stiffener / R.Vissé	99010113	0,41	10
R. Atornillado 800 Bolted stiffener / R.Vissé	99010114	0,47	10
R. Atornillado 900 Bolted stiffener / R.Vissé	99010115	0,53	10
R. Atornillado 1000 Bolted stiffener / R.Vissé	99010116	0,59	10

RAL 7046 Gris / Grey / Gris

**Chapas laterales y frontales**

Side and front plates / Tôles latérales et avant

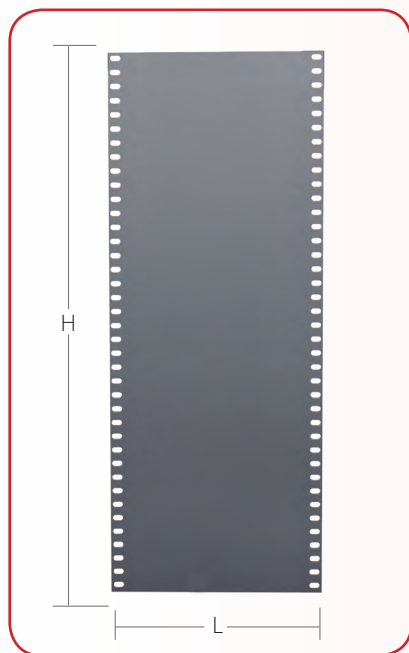

Artículo LxH Item LxH Article LxH	Referencia Reference Référence	Peso kg Weight kg Poids kg	Uds. paquete Units package Unités par paquet
Chapa 300 x 1000H Plate / Tôle	99010123	1,34	1
Chapa 400 x 1000H Plate / Tôle	99010124	1,80	1
Chapa 500 x 1000H Plate / Tôle	99010125	2,26	1
Chapa 600 x 1000H Plate / Tôle	99010126	2,72	1
Chapa 700 x 1000H Plate / Tôle	99010127	3,16	1
Chapa 800 x 1000H Plate / Tôle	99010128	3,62	1
Chapa 900 x 1000H Plate / Tôle	99010129	4,08	1
Chapa 1000 x 1000H Plate / Tôle	99010130	4,54	1

RAL 7046 Gris / Grey / Gris

# Ángulo ranurado / Slotted angle shelving / Rayonnage à visser

## Kits Almacén



  
RAL 9003 Blanco  
White  
Blanc

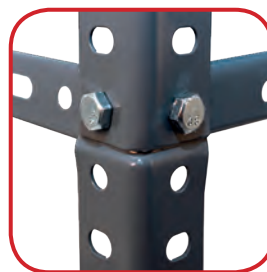

  
RAL 7046 Gris  
Grey  
Gris



muebles  
**INTERMOBEL**



Con tornillos  
With bolts  
Avec vis



Peso por balda  
Weight per shelf  
Poids par tablette

**Unidades**  
Units / Unités**Almacén 5.30**

Artículo Item Article	Referencia Reference Référence	Peso kg Weight kg Poids kg	Uds. paquete Units package Unités par paquet	Dim. pakaging Dim. packaging Dim. d'emballage	Unidades palé Pallet units Unités par palettes
Almacén 5.30	98017830	14,37	1	900H x 320W x 105D	40

RAL 9003 Blanco / White / Blanc

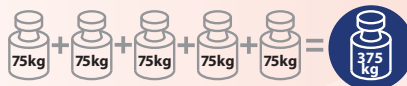
Tiempo de montaje  
Assembly time  
Temps de d'assemblage**Almacén 5.40**

Artículo Item Article	Referencia Reference Référence	Peso kg Weight kg Poids kg	Uds. paquete Units package Unités par paquet	Dim. pakaging Dim. packaging Dim. d'emballage	Unidades palé Pallet units Unités par palettes
Almacén 5.40	98017840	16,61	1	900H x 420W x 105D	26

RAL 9003 Blanco / White / Blanc

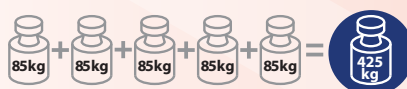
Tiempo de montaje  
Assembly time  
Temps de d'assemblage**Unidades**  
Units / Unités**Almacén 5.30**

Artículo Item Article	Referencia Reference Référence	Peso kg Weight kg Poids kg	Uds. paquete Units package Unités par paquet	Dim. pakaging Dim. packaging Dim. d'emballage	Unidades palé Pallet units Unités par palettes
Almacén 5.30	98017930	14,37	1	900H x 320W x 105D	40

RAL 7046 Gris / Grey / Gris

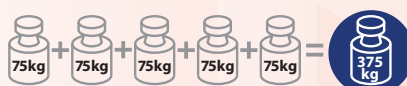
Tiempo de montaje  
Assembly time  
Temps de d'assemblage**Unidades**  
Units / Unités**Almacén 5.40**

Artículo Item Article	Referencia Reference Référence	Peso kg Weight kg Poids kg	Uds. paquete Units package Unités par paquet	Dim. pakaging Dim. packaging Dim. d'emballage	Unidades palé Pallet units Unités par palettes
Almacén 5.40	98017940	16,61	1	900Hx 420W x 105W	26

RAL 7046 Gris / Grey / Gris

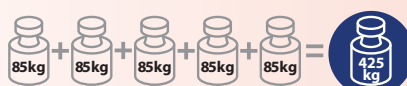
Tiempo de montaje  
Assembly time  
Temps de d'assemblage

GRUPPO  
muebles  
**INTERMOBEL**



**Ideal para poner orden en garajes y trasteros, muy fácil de montar, perfecta para almacenaje de cargas ligeras.**

Ideal to put order in garages and storage rooms, very easy to assemble, perfect for storage of light loads.

Idéal pour entreposer dans les garages, pièce de stockage et débarras, montage très facile, parfait pour stockage des charges légères.

**J 35**

**Carga admisible: 1250 kg\***  
Allowable load (kg)  
Charge admissible (kg)



**J 40**

**Carga admisible: 1750 kg\***  
Allowable load (kg)  
Charge admissible (kg)



**Altura libre de pandeo (distancia entre el suelo y el primer nivel <200 mm)**

Clearance height (distance from floor to first level <200 mm)

Hauteur libre de flambement (distance entre le sol et le premier niveau <200 mm)

**(\*) Carga admisible (cuatro perfiles) con una distancia de 500 mm entre niveles**

(\*) Allowable load (four uprights) with a distance of 500 mm between levels

(\*) Charge admissible par niveau avec un espace intermédiaire de 500 mm entre 2 niveaux

Longitud Length Longueur	L/700	L/800	L/900	L/1000
	275kg	255kg	235kg	215kg

**Carga uniformemente distribuida / Even distribution of load / Charge répartie uniformément**



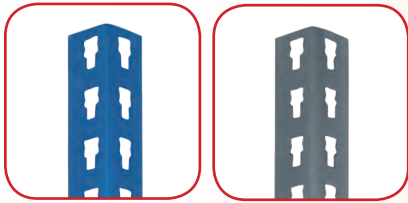

Perfil / Upright / Montant



Larguero V / V Beam / Lisse et traverse

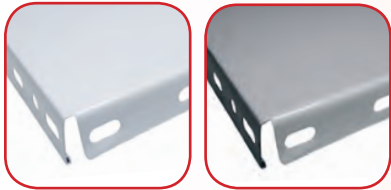

Balda / Shelf / Tablette

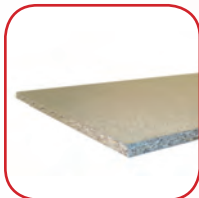

Aglomerado / Chipboard / Aggloméré



Base de plástico / Plastic foot / Pied plastique

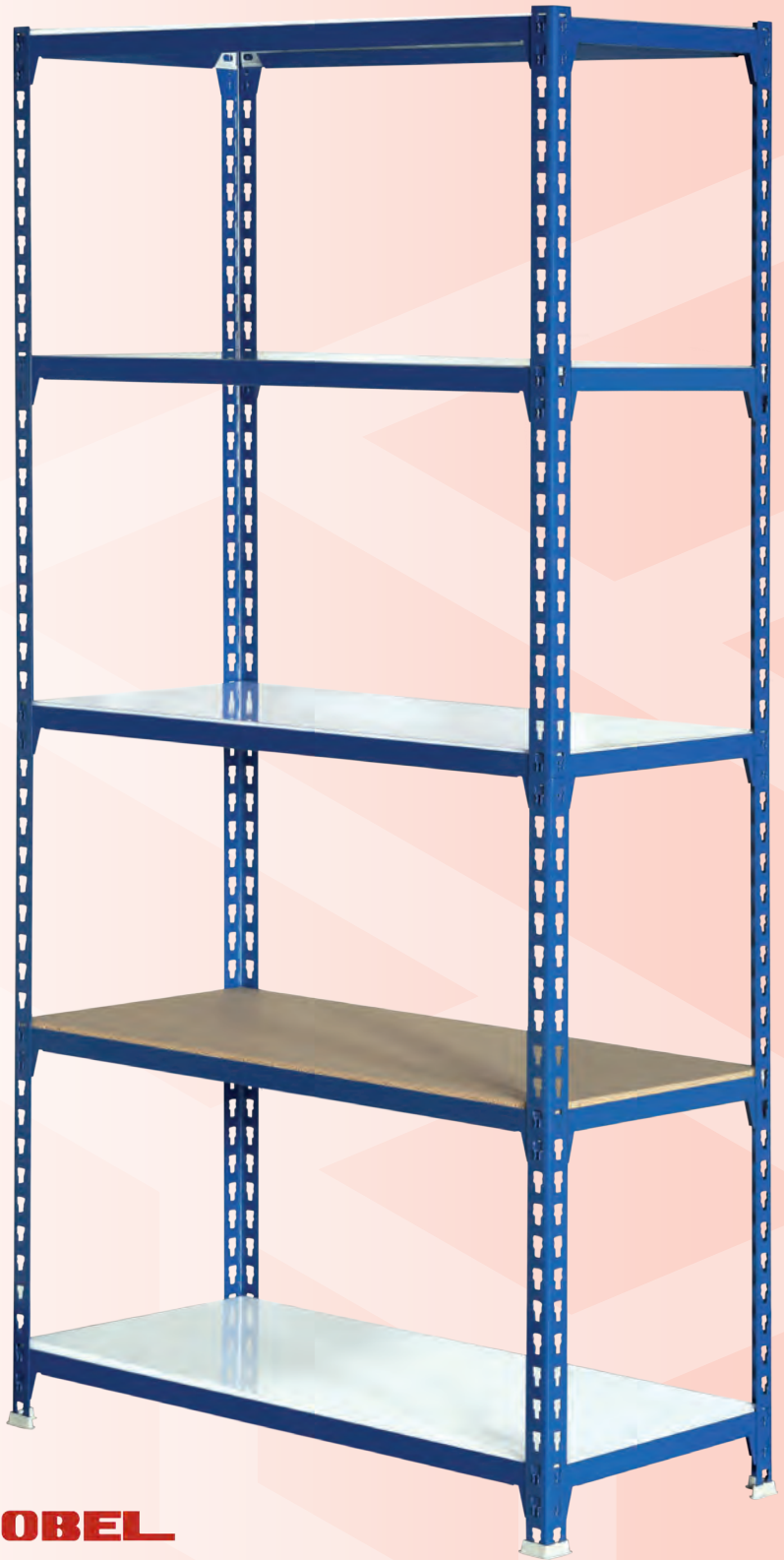

muebles  
GRUPO **INTERMOBEL**

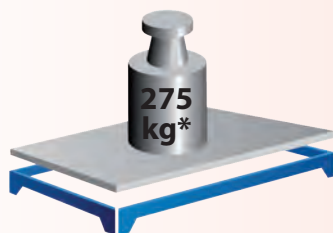

(\*) Carga uniformemente distribuida  
Even distribution of load / Charge répartie uniformément



# J200 sistema de encastre / socket system / système d'assemblage

J/35

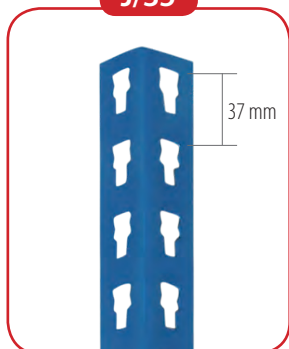

J/40

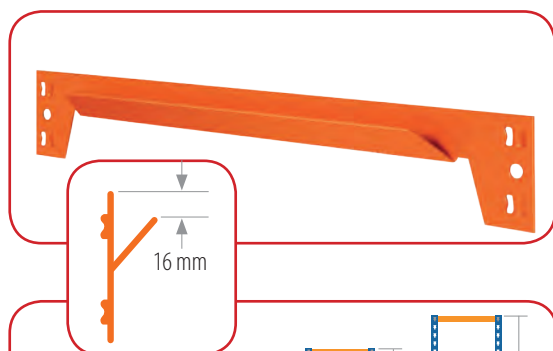
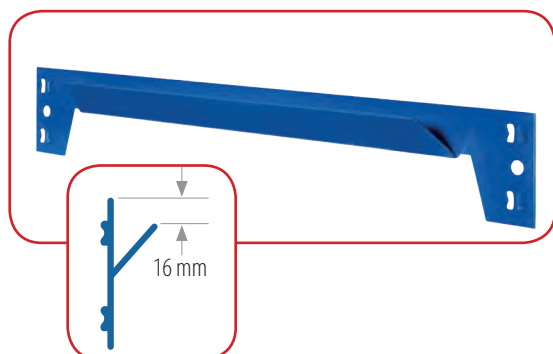
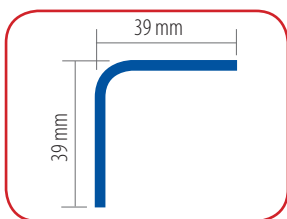
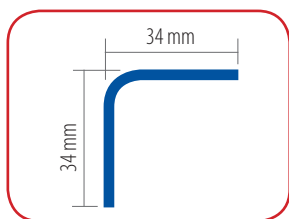
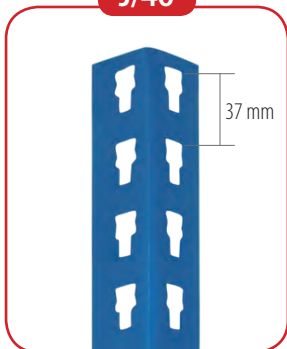

Número mínimo de largueros por altura  
Minimum number of beams by height.  
Nombre minimum de lisses par hauteur.

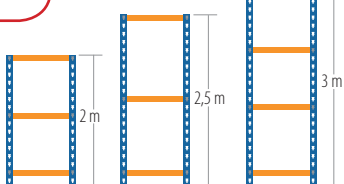

## Perfiles / Uprights / Montants

Artículo L Item L Article L	Ref. Azul Ref. Blue Réf. Bleu	Peso kg Weight kg Poids kg	Uds. Paquete Units Package Unités par paquet
J/35 de 888	73033509	0,66	10
J/35 de 999	73033510	0,74	10
J/35 de 1998	73033520	1,48	10
J/35 de 2479	73033525	1,84	10
J/35 de 2997	73033530	2,22	10

RAL 5010 Azul / Blue / Bleu

## Perfiles / Uprights / Montants

Artículo L Item L Article L	Ref. Azul Ref. Blue Réf. Bleu	Peso kg Weight kg Poids kg	Uds. Paquete Units Package Unités par paquet
J/40 de 1998	75034020	1,83	10
J/40 de 2479	75034025	2,27	10
J/40 de 2997	75034030	2,75	10

RAL 5010 Azul / Blue / Bleu

## Largueros "V" / "V" Beams / Lisses et traverses "V"

Artículo L Item L Article L	Ref. Azul Ref. Blue Réf. Bleu	Peso kg Weight kg Poids kg	Uds. Paquete Units Package Unités par paquet
300	73032030	0,23	10
400	73032040	0,30	10
500	73032050	0,37	10
600	73032060	0,44	10
700	73032070	0,51	10
800	73032080	0,58	10
900	73032090	0,65	10
1000	73032100	0,72	10

RAL 5010 Azul / Blue / Bleu

GRUPO m u e d i e s  
**INTERMOBEL**

## Largueros "V" / "V" Beams / Lisses et traverses "V"

Artículo L Item L Article L	Ref. Naranja Ref. Orange Réf. Orange	Peso kg Weight kg Poids kg	Uds. Paquete Units Package Unités par paquet
300	73042030	0,23	10
400	73042040	0,30	10
500	73042050	0,37	10
600	73042060	0,44	10
700	73042070	0,51	10
800	73042080	0,58	10
900	73042090	0,65	10
1000	73042100	0,72	10

RAL 2004 Naranja / Orange / Orange

**J 35**

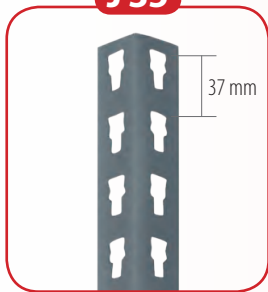

**J 40**

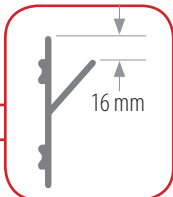
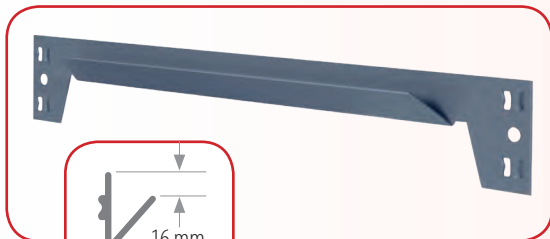
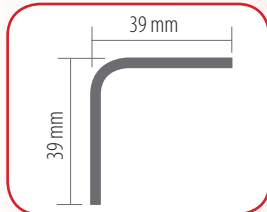
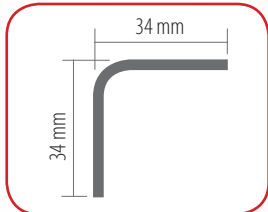
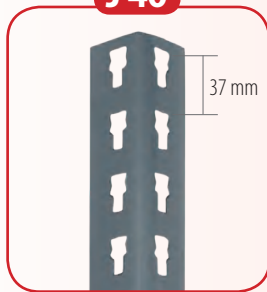

**Número mínimo de largueros por altura**

Minimum number of beams by height.

Minimum Barre transversale par hauteur.

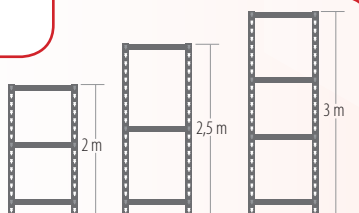

**Espesor / Thickness / Épaisseur**

**Perfiles / Uprights / Montants**

Artículo L Item L Article L	Ref. Gris Ref. Grey Réf. Gris	Peso kg Weight kg Poids kg	Uds. Paquete Units Package Unités par paquet
J/35 de 888	73013509	0,66	10
J/35 de 999	73013510	0,74	10
J/35 de 1998	73013520	1,48	10
J/35 de 2479	73013525	1,84	10
J/35 de 2997	73013530	2,22	10

**RAL 7046 Gris / Grey / Gris**

**Perfiles / Uprights / Montants**

Artículo L Item L Article L	Ref. Gris Ref. Grey Réf. Gris	Peso kg Weight kg Poids kg	Uds. Paquete Units Package Unités par paquet
J/40 de 1998	75014020	1,83	10
J/40 de 2479	75014025	2,27	10
J/40 de 2997	75014030	2,75	10

**RAL 7046 Gris / Grey / Gris**

**Largueros "V" / "V" Beams / Lisses et traverses "V"**

Artículo L Item L Article L	Ref. Gris Ref. Grey Réf. Gris	Peso kg Weight kg Poids kg	Uds. Paquete Units Package Unités par paquet
300	73012030	0,23	10
400	73012040	0,30	10
500	73012050	0,37	10
600	73012060	0,44	10
700	73012070	0,51	10
800	73012080	0,58	10
900	73012090	0,65	10
1000	73012100	0,72	10

**RAL 7046 Gris / Grey / Gris**

**Agglomerado / Chipboard / Aggloméré**

Artículo LxP Item LxD Article LxP	Referencia Reference Référence	Peso kg Weight kg Poids kg	Uds. Paquete Units Package Unités par paquet
690 x 300	73070030	2,12	1
690 x 400	73070040	2,83	1
690 x 500	73070050	3,53	1
690 x 600	73070060	4,24	1
790 x 300	73080030	2,43	1
790 x 400	73080040	3,24	1
790 x 500	73080050	4,04	1
790 x 600	73080060	4,85	1
890 x 300	73090030	2,73	1
890 x 400	73090040	3,65	1
890 x 500	73090050	4,56	1
890 x 600	73090060	5,47	1
990 x 300	73100030	3,04	1
990 x 400	73100040	4,06	1
990 x 500	73100050	5,07	1
990 x 600	73100060	6,08	1

# J200 sistema de encastre / socket system / système d'assemblage

J/35

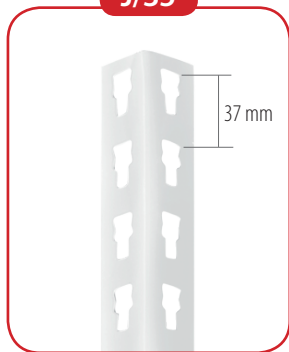

J/40

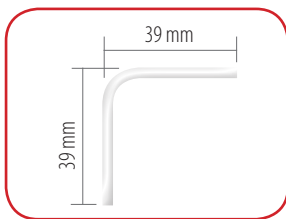
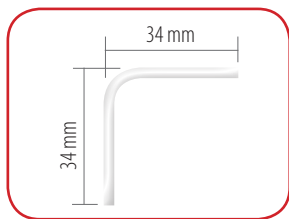
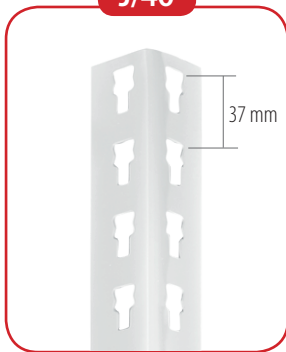

## Perfiles / Uprights / Montants

Artículo L Item L Article L	Ref. Azul Ref. Blue Réf. Bleu	Peso kg Weight kg Poids kg	Uds. Paquete Units Package Unités par paquet
J/35 de 888	73023509	0,66	10
J/35 de 999	73023510	0,74	10
J/35 de 1998	73023520	1,48	10
J/35 de 2479	73023525	1,84	10
J/35 de 2997	73023530	2,22	10

RAL 9003 Blanco / Blue / Bleu

## Perfiles / Uprights / Montants

Artículo L Item L Article L	Ref. Azul Ref. Blue Réf. Bleu	Peso kg Weight kg Poids kg	Uds. Paquete Units Package Unités par paquet
J/40 de 1998	75024020	1,83	10
J/40 de 2479	75024025	2,27	10
J/40 de 2997	75024030	2,75	10

RAL 9003 Blanco / Blue / Bleu

muebles  
**INTERMOBEL**

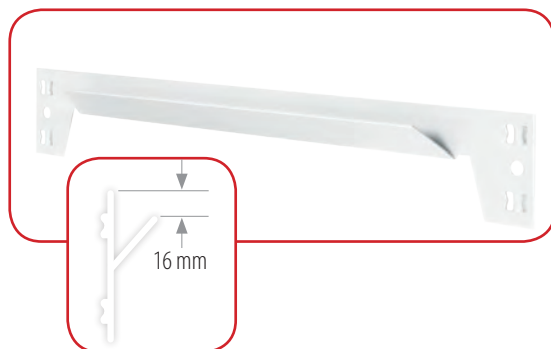

## Largueros "V" / "V" Beams / Lisses et traverses "V"

Artículo L Item L Article L	Ref. Azul Ref. Blue Réf. Bleu	Peso kg Weight kg Poids kg	Uds. Paquete Units Package Unités par paquet
300	73022030	0,23	10
400	73022040	0,30	10
500	73022050	0,37	10
600	73022060	0,44	10
700	73022070	0,51	10
800	73022080	0,58	10
900	73022090	0,65	10
1000	73022100	0,72	10

RAL 9003 Blanco / Blue / Bleu

## Accesorios / accessories / accessoires

Artículo L Item L Article L	Referencia Reference Référence	Peso kg Weight kg Poids kg	Uds. Paquete Units Package Unités par paquet
Pletina 1,5 mm. 1.5 mm L. plate P. de calage 1,5 mm.	75000008	0,02	4
Pie Metálico Metal foot Pied métallique	75000031	0,04	4
Unión Perfil - Gris Bracket union - Grey Union Profilé - Gris	75000032	0,09	4
Unión Perfil - Azul Bracket union - Blue Union Profilé - Bleu	75000033	0,09	4
Unión Perfil - Blanco Bracket union - White Union Profilé - Blanc	75000034	0,09	4
Anclaje M6x60/suelo M6x60 Anchor/ floor Ancrage M6x60/sol	75000035	0,01	4

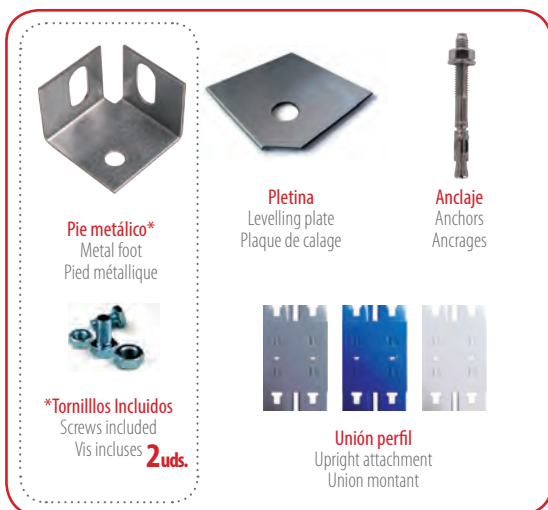

## Baldas / Shelves / Tablettes



Artículo LxP Item LxD Article LxP	Referencia Reference Référence	Peso kg Weight kg Poids kg	Uds. paquete Units package Unités par paquet
700 x 300	99020703	1,67	6
700 x 400	99020704	2,09	6
700 x 500	99020705	2,86	6
700 x 600	99020706	3,33	6
800 x 300	99020803	1,90	6
800 x 400	99020804	2,36	6
800 x 500	99020805	3,24	6
800 x 600	99020806	3,77	6
900 x 300	99020903	2,12	6
900 x 400	99020904	2,64	6
900 x 500	99020905	3,61	6
900 x 600	99020906	4,21	6
1000 x 300	99021003	2,34	6
1000 x 400	99021004	2,91	6
1000 x 500	99021005	3,99	6
1000 x 600	99021006	4,65	6

RAL 9003 Blanco / White / Blanc



GRUPO muebles  
**INTERMOBEL**

## Baldas / Shelves / Tablettes

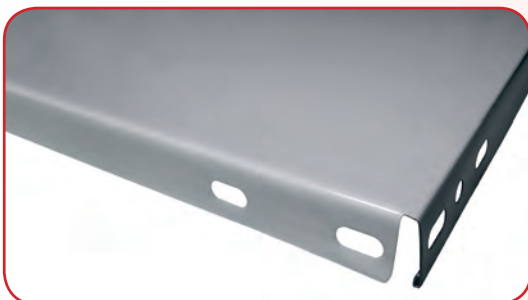

Artículo LxP Item LxD Article LxP	Referencia Reference Référence	Peso kg Weight kg Poids kg	Uds. paquete Units package Unités par paquet
700 x 300	99010703	1,67	6
700 x 400	99010704	2,09	6
700 x 500	99010705	2,86	6
700 x 600	99010706	3,33	6
800 x 300	99010803	1,90	6
800 x 400	99010804	2,36	6
800 x 500	99010805	3,24	6
800 x 600	99010806	3,77	6
900 x 300	99010903	2,12	6
900 x 400	99010904	2,64	6
900 x 500	99010905	3,61	6
900 x 600	99010906	4,21	6
1000 x 300	99011003	2,34	6
1000 x 400	99011004	2,91	6
1000 x 500	99011005	3,99	6
1000 x 600	99011006	4,65	6

RAL 7046 Gris / Grey / Gris



**RAL 7046 Gris**  
Grey  
Gris



**RAL 5010 Azul**  
Blue  
Bleu

**RAL 9003 Blanco**  
White  
Blanc

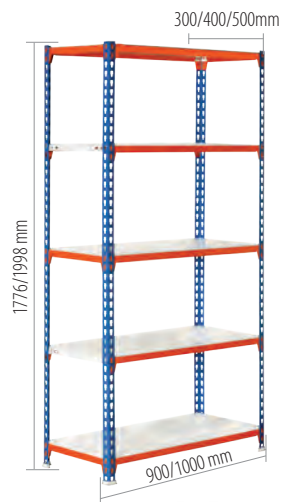

**RAL 5010 Azul**  
Blue  
Bleu

**RAL 2004 Naranja**  
Orange  
Orange

**RAL 9003 Blanco**  
White  
Blanc



**Sin tornillos**  
Without bolts  
Sans vis



**Martillo nylon**  
Nylon hammer  
Marteau nylon



**Tiempo de montaje**  
Assembly time  
Temps de d'assemblage

## J200 5 niveles / J200 5 levels / J200 5 niveaux

**Unidades**  
Units / Unités

**8**  
888 / 999 mm

**4**

**6**  
300/400/500 mm

**10**  
900/1000 mm

**5**  
900 x 300 mm  
900 x 400 mm  
900 x 500 mm  
1000 x 300 mm  
1000 x 400 mm  
1000 x 500 mm

Artículo Item Article	Ref. Gris Ref. Grey Réf. Gris	Peso kg Weight kg Poids kg	Uds. paquete Units package Unités par paquet	Dim. packaging Dim. packaging Dim. de l'emballage	Unidades palé Pallet units Unités par palettes
J200.1800.900.300.5B	731110935	23,76	1	900H x 315W x 105D	25
J200.1800.900.400.5B	731110945	26,78	1	900H x 415W x 105D	19
J200.1800.900.500.5B	731110955	32,05	1	900H x 515W x 105D	14
J200.2000.1000.300.5B	731111035	26,20	1	1000H x 315W x 105D	25
J200.2000.1000.400.5B	731111045	29,47	1	1000H x 415W x 105D	19
J200.2000.1000.500.5B	731111055	35,29	1	1000H x 515W x 105D	14

RAL 7046 Gris / Grey / Gris

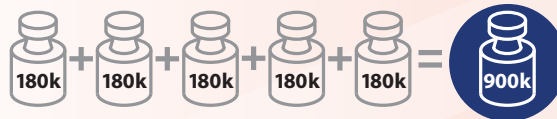

GRUPO **INTERMOBEL**

## J200 5 niveles / J200 5 levels / J200 5 niveaux

**Unidades**  
Units / Unités

**8**  
888 / 999 mm

**4**

**6**  
300/400/500 mm

**10**  
900/1000 mm

**5**  
900 x 300 mm  
900 x 400 mm  
900 x 500 mm  
1000 x 300 mm  
1000 x 400 mm  
1000 x 500 mm

Artículo Item Article	Ref. Azul / Blanco Ref. Blue / White Réf. Bleu / Blanc	Peso kg Weight kg Poids kg	Uds. paquete Units package Unités par paquet	Dim. packaging Dim. packaging Dim. de l'emballage	Unidades palé Pallet units Unités par palettes
J200.1800.900.300.5B	733320935	23,76	1	900H x 315W x 105D	25
J200.1800.900.400.5B	733320945	26,78	1	900H x 415W x 105D	19
J200.1800.900.500.5B	733320955	32,05	1	900H x 515W x 105D	14
J200.2000.1000.300.5B	733321035	26,20	1	1000H x 315W x 105D	25
J200.2000.1000.400.5B	733321045	29,47	1	1000H x 415W x 105D	19
J200.2000.1000.500.5B	733321055	35,29	1	1000H x 515W x 105D	14

RAL 5010 Azul / Blue / Bleu RAL 9003 Blanco / White / Blanc

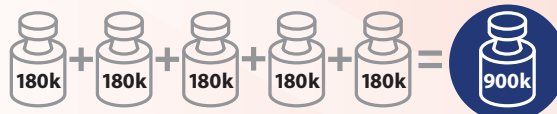

## J200 5 niveles / J200 5 levels / J200 5 niveaux

**Unidades**  
Units / Unités

**8**  
888 / 999 mm

**4**

**6**  
300/400/500 mm

**10**  
900/1000 mm

**5**  
900 x 300 mm  
900 x 400 mm  
900 x 500 mm  
1000 x 300 mm  
1000 x 400 mm  
1000 x 500 mm

Artículo Item Article	Ref. Azul / Naranja / Blanco Ref. Blue / Orange / White Réf. Bleu / Orange / Blanc	Peso kg Weight kg Poids kg	Uds. paquete Units package Unités par paquet	Dim. packaging Dim. packaging Dim. de l'emballage	Unidades palé Pallet units Unités par palettes
J200.1800.900.300.5B	733420935	23,76	1	900H x 315W x 105D	25
J200.1800.900.400.5B	733420945	26,78	1	900H x 415W x 105D	19
J200.1800.900.500.5B	733420955	32,05	1	900H x 515W x 105D	14
J200.2000.1000.300.5B	733421035	26,20	1	1000H x 315W x 105D	25
J200.2000.1000.400.5B	733421045	29,47	1	1000H x 415W x 105D	19
J200.2000.1000.500.5B	733421055	35,29	1	1000H x 515W x 105D	14

RAL 5010 Azul / Blue / Bleu RAL 2004 Naranja / Orange / Orange RAL 9003 Blanco / White / Blanc

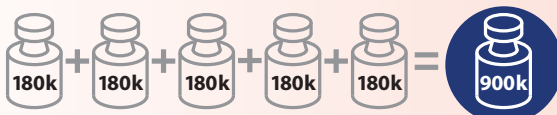

# kits juegos completos / complete kits / Kits étagère

Aglomerado / Chipboard / Aggloméré

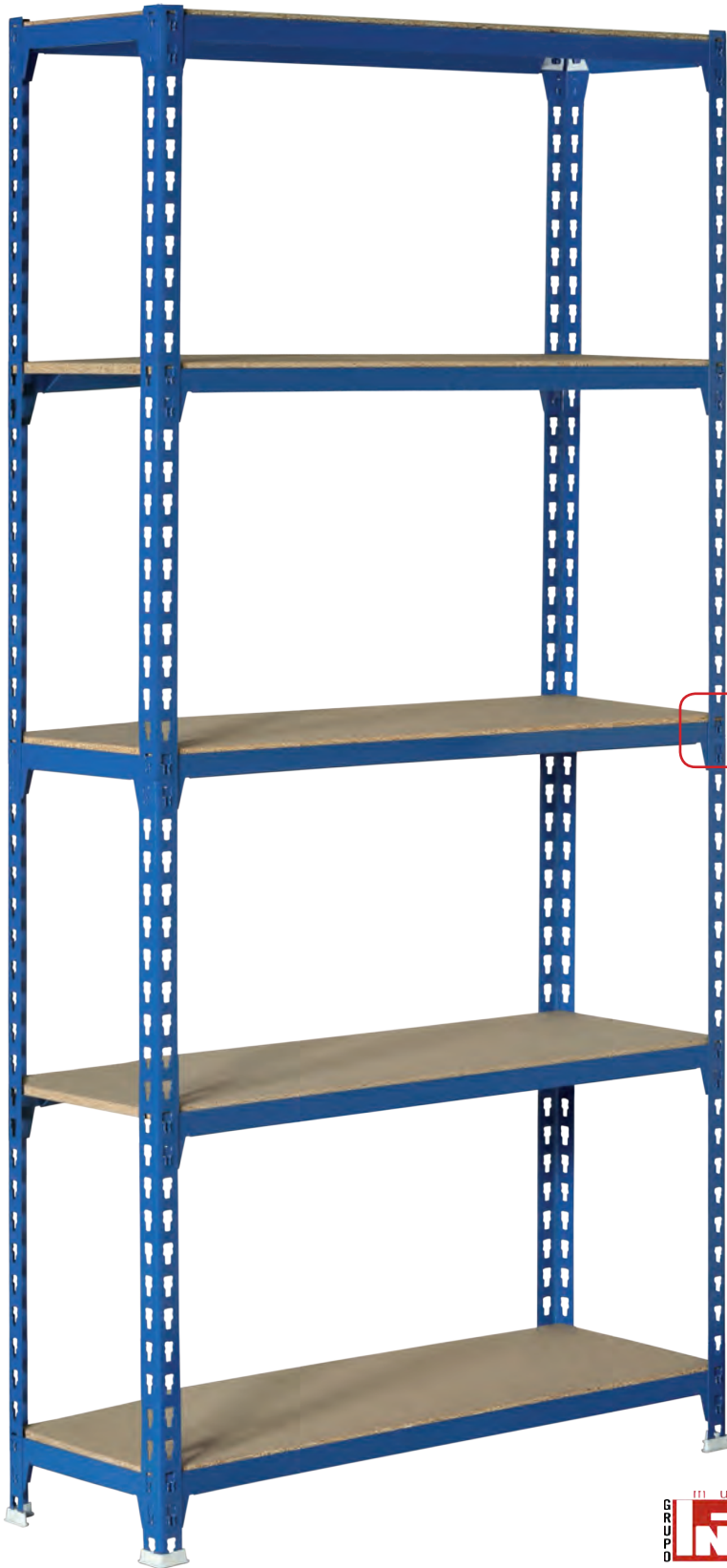

**RAL 7046 Gris**  
Grey  
Gris



**RAL 5010 Azul**  
Blue  
Bleu

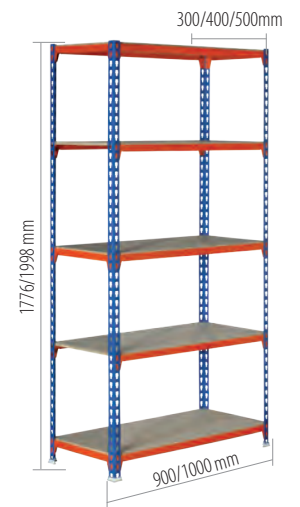

**RAL 5010 Azul** **RAL 2004 Naranja**  
Blue Orange  
Bleu Orange

muebles  
**INTERMOBEL**



**Sin tornillos**  
Without bolts  
Sans vis



**Martillo nylon**  
Nylon hammer  
Marteau nylon



**Tiempo de montaje**  
Assembly time  
Temps de assemblage



## J200 5 niveles / J200 5 levels / J200 5 niveaux

Unidades Units / Unités	
	<b>8</b> 888 / 999 mm
	<b>4</b>
	<b>6</b> 300/400/500 mm
	<b>10</b> 900/1000 mm
	<b>5</b> 890 x 300 mm 890 x 400 mm 890 x 500 mm 990 x 300 mm 990 x 400 mm 990 x 500 mm

Artículo Item Article	Ref. Gris Ref. Grey Réf. Gris	Peso kg Weight kg Poids kg	Uds. paquete Units package Unités par paquet	Dim. pakaging Dim. packaging Dim. de l'emballage	Unidades palé Pallet units Unités par palettes
J200.1800.900.300.5A	731100935	23,71	1	900H x 310W x 95D	27
J200/1800.900.400.5A	731100945	27,68	1	900H x 410W x 95D	21
J200.1800.900.500.5A	731100955	31,60	1	900H x 510W x 95D	14
J200.2000.1000.300.5A	731101035	26,25	1	1000H x 310W x 95D	27
J200.2000.1000.400.5A	731101045	30,62	1	1000H x 410W x 95D	21
J200.2000.1000.500.5A	731101055	34,94	1	1000H x 510W x 95D	14

RAL 7046 Gris / Grey / Gris

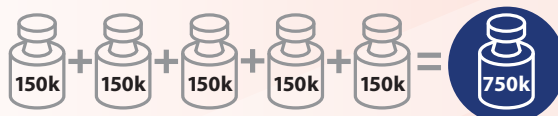

## J200 5 niveles / J200 5 levels / J200 5 niveaux

Unidades Units / Unités	
	<b>8</b> 888 / 999 mm
	<b>4</b>
	<b>6</b> 300/400/500 mm
	<b>10</b> 900/1000 mm
	<b>5</b> 890 x 300 mm 890 x 400 mm 890 x 500 mm 990 x 300 mm 990 x 400 mm 990 x 500 mm

Artículo Item Article	Ref. Azul Ref. Blue Réf. Bleu	Peso kg Weight kg Poids kg	Uds. paquete Units package Unités par paquet	Dim. pakaging Dim. packaging Dim. de l'emballage	Unidades palé Pallet units Unités par palettes
J200.1800.900.300.5A	733300935	23,71	1	900H x 310W x 95D	27
J200/1800.900.400.5A	733300945	27,68	1	900H x 410W x 95D	21
J200.1800.900.500.5A	733300955	31,60	1	900H x 510W x 95D	14
J200.2000.1000.300.5A	733301035	26,25	1	1000H x 310W x 95D	27
J200.2000.1000.400.5A	733301045	30,62	1	1000H x 410W x 95D	21
J200.2000.1000.500.5A	733301055	34,94	1	1000H x 510W x 95D	14

RAL 5010 Azul / Blue / Bleu



GRUPO **INTERMOBEL**

## J200 5 niveles / J200 5 levels / J200 5 niveaux

Unidades Units / Unités	
	<b>8</b> 888 / 999 mm
	<b>4</b>
	<b>6</b> 300/400/500 mm
	<b>10</b> 900/1000 mm
	<b>5</b> 890 x 300 mm 890 x 400 mm 890 x 500 mm 990 x 300 mm 990 x 400 mm 990 x 500 mm

Artículo Item Article	Ref. Azul / Naranja Ref. Blue / Orange Réf. Bleu / Orange	Peso kg Weight kg Poids kg	Uds. paquete Units package Unités par paquet	Dim. pakaging Dim. packaging Dim. de l'emballage	Unidades palé Pallet units Unités par palette
J200.1800.900.300.5A	733400935	23,71	1	900H x 310W x 95D	27
J200/1800.900.400.5A	733400945	27,68	1	900H x 410W x 95D	21
J200.1800.900.500.5A	733400955	31,60	1	900H x 510W x 95D	14
J200.2000.1000.300.5A	733401035	26,25	1	1000H x 310W x 95D	27
J200.2000.1000.400.5A	733401045	30,62	1	1000H x 410W x 95D	21
J200.2000.1000.500.5A	733401055	34,94	1	1000H x 510W x 95D	14

RAL 5010 Azul / Blue / Bleu RAL 2004 Naranja / Orange / Orange

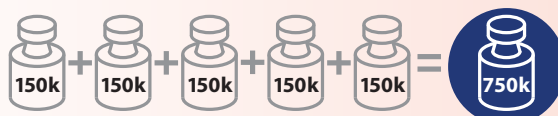



**Altura libre de pandeo**  
**(distancia entre el suelo y el primer nivel <200 mm)**  
 Clearance height  
 (distance from floor to first level <200 mm)  
 Hauteur libre de flambement  
 (distance entre le sol et le premier niveau <200 mm)

**(\*) Carga admisible (cuatro perfiles)**  
**con una distancia de 500 mm entre niveles**  
 (\*) Allowable load (four uprights)  
 with a distance of 500 mm between levels  
 (\*) Charge admissible (quatre montants)  
 avec une distance de 500 mm entre les niveaux

muebles  
**INTERMOBEL**

Larguero Beam Longueron	L/900	L/1200	L/1500	L/1800	L/2100	L/2400
	500 kg	500 kg	500 kg	500 kg	350 kg	350 kg

**Carga uniformemente distribuida**  
 Even distribution of load / Charge répartie uniformément

Perfil / Upright / Montant



**Base sencilla 40**  
Single foot / Pied pastique

Fondo "L"  
"L" Cross beam / Lisse



**Aglomerado**  
Chipboard  
Aggloméré

Larguero "C"  
"C" Beam / Traverse C

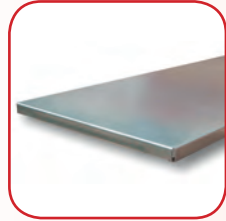

**Balda galvanizada**  
Galvanised shelf  
Tablette galvanisée

Travesaño de refuerzo  
Deck support / Barre de renfort



**Accesorios** / accessories / accessoires

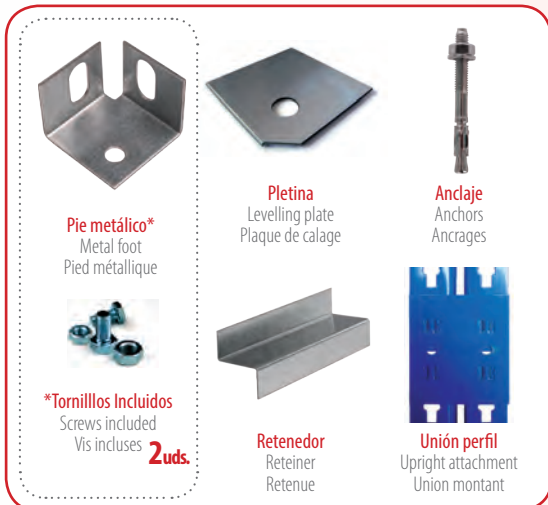

**Pie metálico\***  
Metal foot  
Pied métallique

**Pletina**  
Levelling plate  
Plaque de calage

**Andaje**  
Anchors  
Ancrages

\*Tornillos Incluidos  
Screws included  
Vis incluses **2uds.**

**Retenedor**  
Retainer  
Retenue

**Unión perfil**  
Upright attachment  
Union montant

Artículo L Item L Article L	Referencia Reference Référence	Peso k Weight k Poids k	Uds. Paquete Units Package Unités par paquet
Pletina 1,5 mm. 1.5 mm L. plate P. de calage 1,5 mm.	75000008	0,02	4
Pie Metálico Metal foot Pied métallique	75000031	0,04	4
Unión Perfil Upright attachment Cornière d'assemblage	75000033	0,09	4
Andaje M6x60/suelo M6x60 Anchor/floor Ancrage M6x60/sol	75000035	0,01	4
Retenedor GV. Retainer GV. Retenue GV.	75000036	0,03	2

# J600 sistema de encastre / socket system / système d'assemblage

GRUPO muebles  
**INTERMOBEL**

J/40

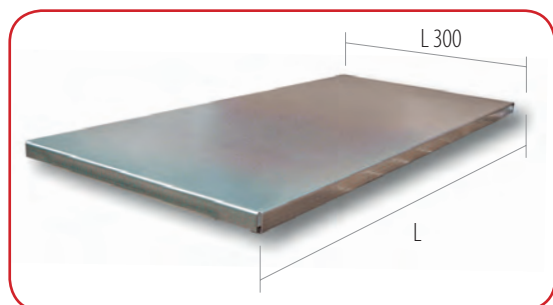
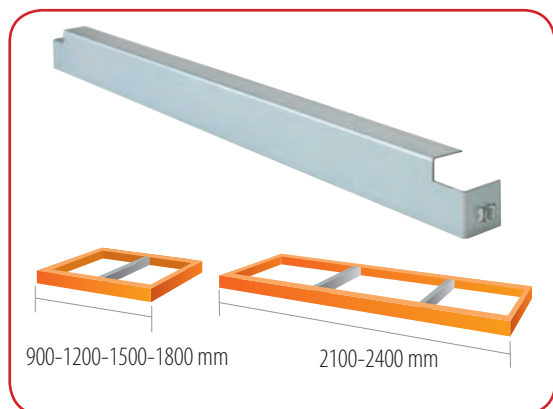
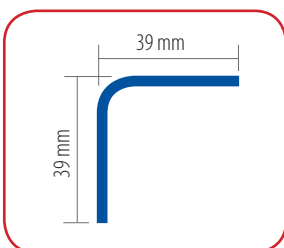
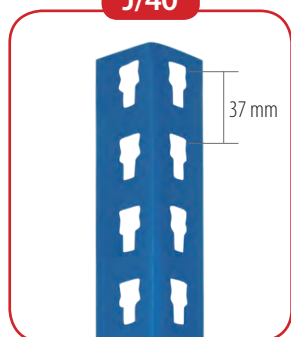

## Perfiles / Uprights / Montants

Artículo L Item L Article L	Ref. Azul Ref. Blue Réf. Bleu	Peso kg Weight kg Poids kg	Uds. Paquete Units Package Unités Paquet
J/40 de 1998	75034020	1,83	10
J/40 de 2479	75034025	2,27	10
J/40 de 2997	75034030	2,75	10

RAL 5010 Azul / Blue / Bleu

## Fondos "L" / "L" Cross beams / Traverses "L"

Artículo L Item L Article L	Ref. Naranja Ref. Orange Réf. Orange	Peso kg Weight kg Poids kg	Uds. Paquete Units Package Unités Paquet
L0300 / L	75041030	0,30	10
L0450 / L	75041045	0,45	10
L0600 / L	75041060	0,60	10
L0750 / L	75041075	0,75	10
L0900 / L	75041090	0,90	10
L1000 / L	75041100	1,00	10

RAL 2004 Naranja / Orange / Orange

## Largueros "C" / "C" Beams / Lisses "C"

Artículo L Item L Article L	Ref. Naranja Ref. Orange Réf. Orange	Peso kg Weight kg Poids kg	Uds. Paquete Units Package Unités Paquet
L0900 / C	75042090	1,15	10
L1200 / C	75042120	1,53	10
L1500 / C	75042150	1,91	10
L1800 / C	75042180	2,74	6
L2100 / C	75042210	3,20	6
L2400 / C	75042240	3,66	6

RAL 2004 Naranja / Orange / Orange

## Travesaños de refuerzo / Deck supports / Barres de renforcement

Artículo L Item L Article L	Ref. Naranja Ref. Orange Réf. Orange	Peso kg Weight kg Poids kg	Uds. Paquete Units Package Unités Paquet
L0450	75093045	0,44	10
L0600	75093060	0,57	10
L0750	75093075	0,70	10
L0900	75093090	0,83	10
L1000	75093100	0,92	10
L1200	75093120	0,96	10
L1500	75093150	1,09	10

Galvanizado / Galvanised / Galvanisée

## Baldas / Shelves / Tablettes

Artículo LxP Item LxD Article LxP	Referencia Reference Référence	Peso kg Weight kg Poids kg	Uds. Paquete Units Package Unités Paquet
300 x 300	75094030	0,75	10
450 x 300	75094045	1,04	10
600 x 300	75094060	1,33	10
750 x 300	75094075	1,62	10
900 x 300	75094090	1,91	10
1000 x 300	75094100	2,09	10

Galvanizado / Galvanised / Galvanisée

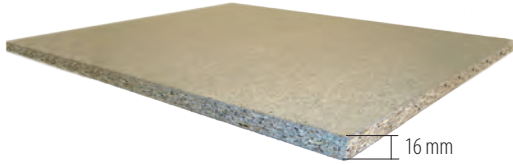

Espesor / Thickness / Épaisseur

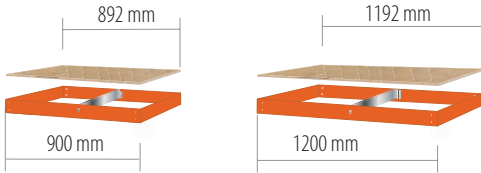

### Aglomerado 1 pieza / Chipboard 1 item / Aggloméré 1 pièce

Artículo LxP Item LxD Article LxP	Referencia Reference Référence	Peso kg Weight kg Poids kg	Uds. Paquete Units Package Unités par paquet
892 x 294	75090030	2,66	1
892 x 444	75090045	4,10	1
892 x 594	75090060	5,43	1
892 x 744	75090075	6,76	1
892 x 894	75090090	8,19	1
892 x 994	75090100	9,11	1
1192 x 294	75120030	3,58	1
1192 x 444	75120045	5,43	1
1192 x 594	75120060	7,27	1
1192 x 744	75120075	9,11	1
1192 x 894	75120090	10,96	1
1192 x 994	75120100	12,08	1

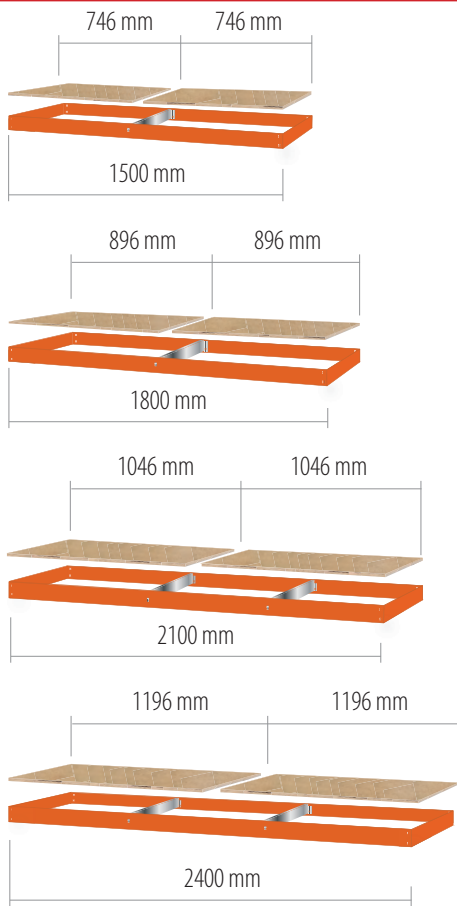

### Aglomerado 2 piezas / Chipboard 2 items / Aggloméré 2 pièces

Artículo LxP Item LxD Article LxP	Referencia Reference Référence	Peso kg Weight kg Poids kg	Uds. Paquete Units Package Unités par paquet
746 + 746 x 294	75150030	4,51	1 + 1
746 + 746 x 444	75150045	6,76	1 + 1
746 + 746 x 594	75150060	9,11	1 + 1
746 + 746 x 744	75150075	11,37	1 + 1
746 + 746 x 894	75150090	13,62	1 + 1
746 + 746 x 994	75150100	15,16	1 + 1
896 + 896 x 294	75180030	5,43	1 + 1
896 + 896 x 444	75180045	8,19	1 + 1
896 + 896 x 594	75180060	10,85	1 + 1
896 + 896 x 744	75180075	13,62	1 + 1
896 + 896 x 894	75180090	16,38	1 + 1
896 + 896 x 994	75180100	18,23	1 + 1
1046 + 1046 x 294	75210030	6,35	1 + 1
1046 + 1046 x 444	75210045	9,52	1 + 1
1046 + 1046 x 594	75210060	12,70	1 + 1
1046 + 1046 x 744	75210075	15,97	1 + 1
1046 + 1046 x 894	75210090	19,15	1 + 1
1046 + 1046 x 994	75210100	21,30	1 + 1
1196 + 1196 x 294	75240030	7,17	1 + 11
1196 + 1196 x 444	75240045	10,85	1 + 1
1196 + 1196 x 594	75240060	14,54	1 + 1
1196 + 1196 x 744	75240075	18,23	1 + 1
1196 + 1196 x 894	75240090	21,91	1 + 1
1196 + 1196 x 994	75240100	24,37	1 + 1

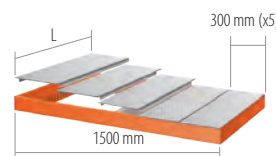
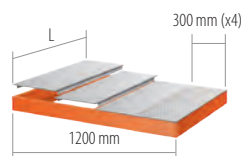
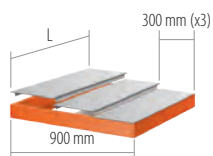

Baldas / Shelves / Tablettes

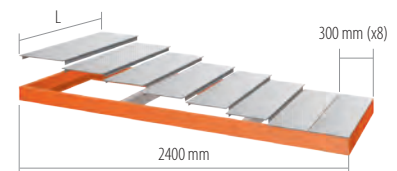
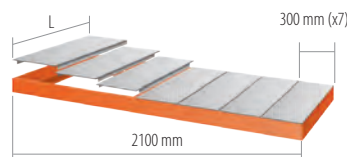
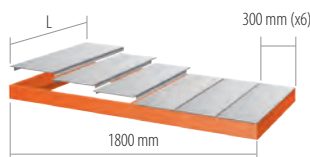

# kits juegos completos / complete kits / Kits étagère

Aglomerado / Chipboard / Aggloméré



**J 40**

**Carga admisible: 1750 kg\***  
Allowable load (kg)  
Charge admissible (kg)



Sin tornillos  
Without bolts  
Sans vis



Martillo nylon  
Nylon hammer  
Marteau nylon



Tiempo de montaje  
Assembly time  
Temps de montage

Larguero Beam Longueron	L/1200	L/1500	L/1800
	500 kg	500 kg	500 kg

GRUPO **INTERMOBEL**

Instrucciones de montaje / Assembly instructions / Instructions d'assemblage

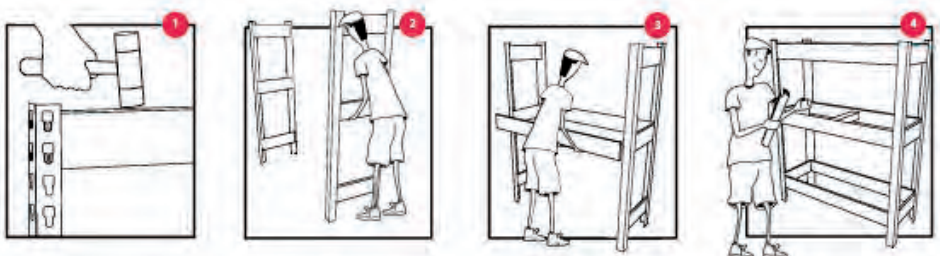

1200.450.3 / 1200.600.3



1500.450.3 / 1500.600.3



1800.450.3 / 1800.600.3

**Unidades**  
Units / Unités

1200.450.3 / 1200.600.3



**4**  
1998 mm



**4**  
40 x 40 mm



**6**  
450/600 mm



**6**  
1200 mm

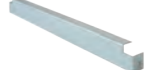

**3**  
450/600 mm

### J600 3 niveles / J600 3 levels / J600 3 niveaux

Artículo Item Article	Ref. Azul / Naranja Ref. Blue / Orange Réf. Bleu / Orange	Peso kg Weight kg Poids kg	Uds. paquete Units package Unités par paquet	Dim. pakaging Dim. packaging Dim. de l'emballage	Unidades palé Pallet units Unités par palettes
J600/1200.450.3	75031243	20,52	1	2000H x 120W x 80D	30
J600/1200.600.3	75031263	21,81	1	2000H x 120W x 80D	30

RAL 5010 Azul / Blue / Bleu RAL 2004 Naranja / Orange / Orange



### Aglomerado / Chipboard / Aggloméré

Artículo Item Article	Referencia Reference Référence	Peso kg Weight kg Poids kg	Uds. envase Units pack Unités emballage	Dim. pakaging Dim. packaging Dim. de l'emballage	Unidades palé Pallet units Unités par palettes
1192 x 444	75120453	16,29	3	1192W x 444D x 48H	30
1192 x 594	75120603	21,81	3	1192W x 594D x 48H	30

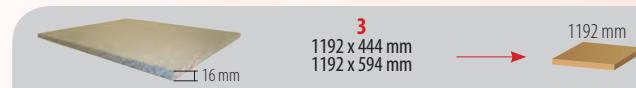

**Unidades**  
Units / Unités

1500.450.3 / 1500.600.3



**4**  
1998 mm



**4**  
40 x 40 mm



**6**  
450/600 mm



**6**  
1500 mm

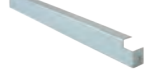

**3**  
450/600 mm

### J600 3 niveles / J600 3 levels / J600 3 niveaux

Artículo Item Article	Ref. Azul / Naranja Ref. Blue / Orange Réf. Bleu / Orange	Peso kg Weight kg Poids kg	Uds. paquete Units package Unités par paquet	Dim. pakaging Dim. packaging Dim. de l'emballage	Unidades palé Pallet units Unités par palettes
J600/1500.450.3	75031543	22,80	1	2000H x 120W x 80D	30
J600/1500.600.3	75031563	24,09	1	2000H x 120W x 80D	30

RAL 5010 Azul / Blue / Bleu RAL 2004 Naranja / Orange / Orange



### Aglomerado / Chipboard / Aggloméré

Artículo Item Article	Referencia Reference Référence	Peso kg Weight kg Poids kg	Uds. envase Units pack Unités emballage	Dim. pakaging Dim. packaging Dim. de l'emballage	Unidades palé Pallet units Unités par palettes
746 + 746 x 444	75075453	20,28	3 + 3	746W x 444D x 96H	30
746 + 746 x 594	75075603	27,33	3 + 3	746W x 594D x 96H	30



**Unidades**  
Units / Unités

1800.450.3 / 1800.600.3



**4**  
1998 mm



**4**  
40 x 40 mm



**6**  
450/600 mm



**6**  
1800 mm

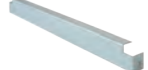

**3**  
450/600 mm

### J600 3 niveles / J600 3 levels / J600 3 niveaux

Artículo Item Article	Ref. Azul / Naranja Ref. Blue / Orange Réf. Bleu / Orange	Peso kg Weight kg Poids kg	Uds. paquete Units package Unités par paquet	Dim. pakaging Dim. packaging Dim. de l'emballage	Unidades palé Pallet units Unités par palettes
J600/1800.450.3	75031843	27,78	1	2000H x 120W x 80D	30
J600/1800.600.3	75031863	29,07	1	2000H x 120W x 80D	30

RAL 5010 Azul / Blue / Bleu RAL 2004 Naranja / Orange / Orange



### Aglomerado / Chipboard / Aggloméré

Artículo Item Article	Referencia Reference Référence	Peso kg Weight kg Poids kg	Uds. envase Units pack Unités emballage	Dim. pakaging Dim. packaging Dim. de l'emballage	Unidades palé Pallet units Unités par palettes
896 + 896 x 444	75090453	24,57	3 + 3	896W x 444D x 96H	30
896 + 896 x 594	75090603	32,55	3 + 3	896W x 594D x 96H	30



GRUPO **INTERMOBEL**

# kits juegos completos / complete kits / Kits étagère

Aglomerado / Chipboard / Aggloméré



1200.450.4 / 1200.600.4



1500.450.4 / 1500.600.4



1800.450.4 / 1800.600.4

**J 40**

**Carga admisible: 1750 kg\***  
Allowable load (kg)  
Charge admissible (kg)



**Sin tornillos**  
Without bolts  
Sans vis



**Martillo nylon**  
Nylon hammer  
Marteau nylon



**Tiempo de montaje**  
Assembly time  
Temps de montage

Larguero Beam Longueron	L/1200	L/1500	L/1800
	500 kg	500 kg	500 kg

GRUP mUEBLES  
**INTERMOBEL**

Instrucciones de montaje / Assembly instructions / Instructions d'assemblage

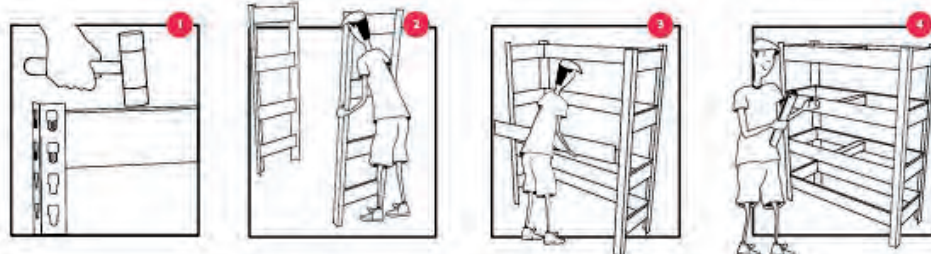



**Unidades**  
Units / Unités

1200.450.3 / 1200.600.3



**4**  
1998 mm



**4**  
40 x 40 mm



**8**  
450/600 mm



**8**  
1200 mm

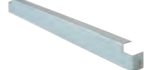

**4**  
450/600 mm

### J600 4 niveles / J600 4 levels / J600 4 niveaux

Artículo Item Article	Ref. Azul / Naranja Ref. Blue / Orange Réf. Bleu / Orange	Peso kg Weight kg Poids kg	Uds. paquete Units package Unités par paquet	Dim. pakaging Dim. packaging Dim. de l'emballage	Unidades palé Pallet units Unités par palettes
J600/1200.450.4	75031244	24,92	1	2000H x 145W x 80D	25
J600/1200.600.4	75031264	26,64	1	2000H x 145W x 80D	25

RAL 5010 Azul / Blue / Bleu RAL 2004 Naranja / Orange / Orange



### Aglomerado / Chipboard / Aggloméré

Artículo Item Article	Referencia Reference Référence	Peso kg Weight kg Poids kg	Uds. envase Units pack Unités emballage	Dim. pakaging Dim. packaging Dim. de l'emballage	Unidades palé Pallet units Unités par palettes
1192 x 444	75120454	21,72	4	1192W x 444D x 64H	25
1192 x 594	75120604	29,08	4	1192W x 594D x 64H	25

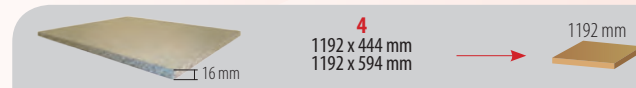

**Unidades**  
Units / Unités

1500.450.3 / 1500.600.3



**4**  
1998 mm



**4**  
40 x 40 mm



**8**  
450/600 mm



**8**  
1500 mm



**4**  
450/600 mm

### J600 4 niveles / J600 4 levels / J600 4 niveaux

Artículo Item Article	Ref. Azul / Naranja Ref. Blue / Orange Réf. Bleu / Orange	Peso kg Weight kg Poids kg	Uds. paquete Units package Unités par paquet	Dim. pakaging Dim. packaging Dim. de l'emballage	Unidades palé Pallet units Unités par palettes
J600/1500.450.4	75031544	27,96	1	2000H x 145W x 80D	25
J600/1500.600.4	75031564	29,68	1	2000H x 145W x 80D	25

RAL 5010 Azul / Blue / Bleu RAL 2004 Naranja / Orange / Orange



### Aglomerado / Chipboard / Aggloméré

Artículo Item Article	Referencia Reference Référence	Peso kg Weight kg Poids kg	Uds. envase Units pack Unités emballage	Dim. pakaging Dim. packaging Dim. de l'emballage	Unidades palé Pallet units Unités par palettes
746 + 746 x 444	75075454	27,04	4 + 4	746W x 444D x 128H	25
746 + 746 x 594	75075604	36,44	4 + 4	746W x 594D x 128H	25



**Unidades**  
Units / Unités

1800.450.3 / 1800.600.3



**4**  
1998 mm



**4**  
40 x 40 mm



**8**  
450/600 mm



**8**  
1800 mm

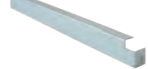

**4**  
450/600 mm

### J600 4 niveles / J600 4 levels / J600 4 niveaux

Artículo Item Article	Ref. Azul / Naranja Ref. Blue / Orange Réf. Bleu / Orange	Peso kg Weight kg Poids kg	Uds. paquete Units package Unités par paquet	Dim. pakaging Dim. packaging Dim. de l'emballage	Unidades palé Pallet units Unités par palettes
J600/1800.450.4	75031844	34,60	1	2000H x 145W x 80D	25
J600/1800.600.4	75031864	36,32	1	2000H x 145W x 80D	25

RAL 5010 Azul / Blue / Bleu RAL 2004 Naranja / Orange / Orange



### Aglomerado / Chipboard / Aggloméré

Artículo Item Article	Referencia Reference Référence	Peso kg Weight kg Poids kg	Uds. envase Units pack Unités emballage	Dim. pakaging Dim. packaging Dim. de l'emballage	Unidades palé Pallet units Unités par palettes
896 + 896 x 444	75090454	32,76	4 + 4	896W x 444D x 128H	25
896 + 896 x 594	75090604	43,40	4 + 4	896W x 594D x 128H	25



# kits bancos de trabajo / workbenches / Établis de travail

## BTS 900 / 1200 / 1500

### bancos de trabajo / work benches / bancs de travail

Artículo Item Article	Ref. Azul / Naranja Ref. Bleu / Orange Réf. Bleu / Orange	Peso kg Weight kg Poids kg	Uds. paquete Units package Unités paquet	Dim. pakaging Dim. packaging Dim. d'emballage	Unidades palé Pallet units Unités palettes
BTS / 900	75030091	21,64	1	900H x 600W x 70D	16
BTS / 1200	75030121	26,84	1	1200H x 600W x 70D	16
BTS / 1500	75030151	32,04	1	1500H x 600W x 70D	16

RAL 5010 Azul / Blue / Bleu RAL 2004 Naranja / Orange / Orange



muebles  
**INTERMOBEL**

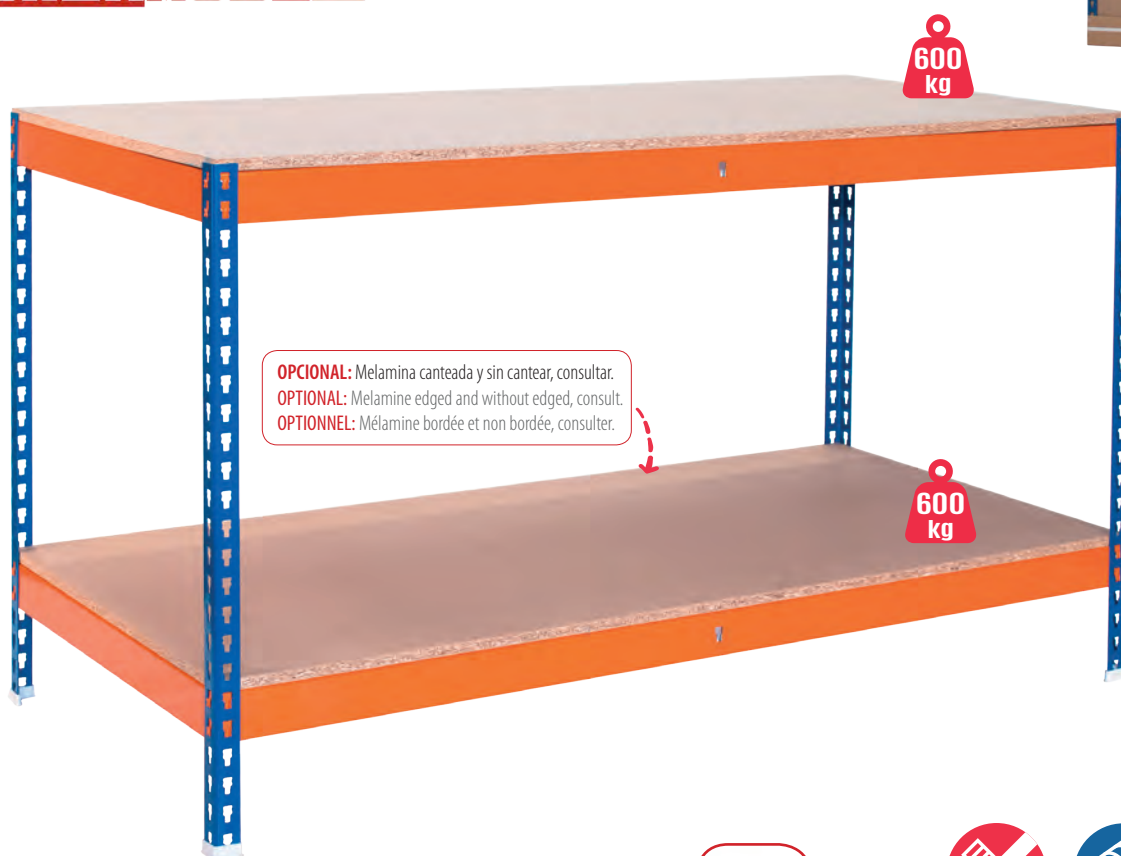

**OPCIONAL:** Melamina canteada y sin cantear, consultar.  
**OPTIONAL:** Melamine edged and without edged, consult.  
**OPTIONNEL:** Mélamine bordée et non bordée, consulter.

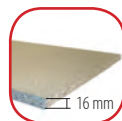

**Sin tornillos**  
Without bolts  
Sans vis



**Martillo nylon**  
Nylon hammer  
Marteau nylon



**Tiempo de montaje**  
Assembly time  
Temps d'assemblage





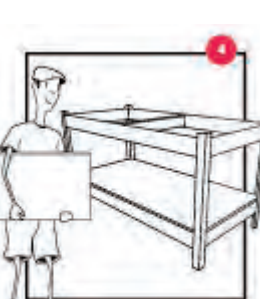
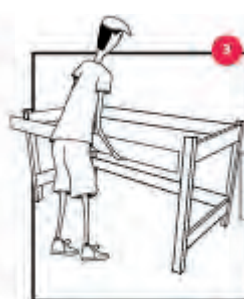

#### Instrucciones de montaje

Assembly instructions







Instructions d'assemblage







**Unidades**  
Units / Unités  
**BTS / 900**

	<b>4</b> 888 mm
	<b>4</b> 35 x 35 mm
	<b>4</b> 600 mm
	<b>4</b> 900 mm
	<b>2</b> 600 mm
	<b>2</b> 892 x 594 mm

**Unidades**  
Units / Unités  
**BTS / 1200**

	<b>4</b> 888 mm
	<b>4</b> 35 x 35 mm
	<b>4</b> 600 mm
	<b>4</b> 1200 mm
	<b>2</b> 600 mm
	<b>2</b> 1192 x 594 mm

**Unidades**  
Units / Unités  
**BTS / 1500**

	<b>4</b> 888 mm
	<b>4</b> 35 x 35 mm
	<b>4</b> 600 mm
	<b>4</b> 1500 mm
	<b>2</b> 600 mm
	<b>2</b> 1492 x 594 mm

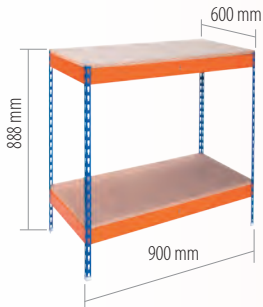

**BTS 900**

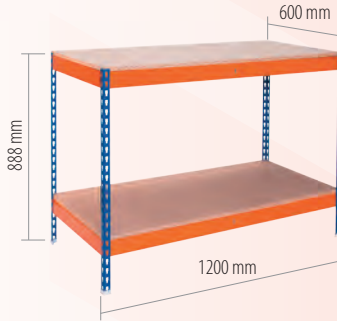



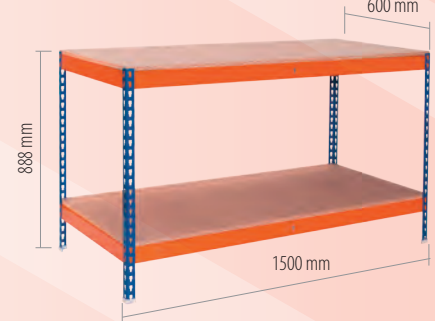

**BTS 1200**



**BTS 1500**

muebles  
**INTERMOBEL**

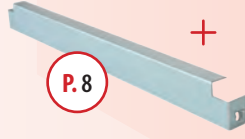
Configure su banco de trabajo según su necesidad  
Configure your workbench as needed / Configurez votre établi de travail selon vos besoins

<p><b>Perfil</b> Upright / Montant</p> <p><b>P. 20</b></p>  <p>888</p>	<p><b>Fondo "L"</b> "L" Cross beam / Lisse</p> <p><b>P. 8</b></p>  <table border="1"> <tr><td>300</td></tr> <tr><td>450</td></tr> <tr><td>600</td></tr> <tr><td>750</td></tr> <tr><td>900</td></tr> <tr><td>1000</td></tr> </table>	300	450	600	750	900	1000	<p><b>Larguero "C"</b> "C" Beam / Traverse C</p> <p><b>P. 8</b></p>  <table border="1"> <tr><td>900</td></tr> <tr><td>1200</td></tr> <tr><td>1500</td></tr> <tr><td>1800</td></tr> <tr><td>2100*</td></tr> <tr><td>2400*</td></tr> </table>	900	1200	1500	1800	2100*	2400*	<p><b>Travesaño de refuerzo</b> Deck support / Barre de renfort</p> <p><b>P. 8</b></p>  <table border="1"> <tr><td>450</td></tr> <tr><td>600</td></tr> <tr><td>750</td></tr> <tr><td>900</td></tr> <tr><td>1000</td></tr> </table>	450	600	750	900	1000	<p><b>Aglomerado</b> Chipboard / Aggloméré</p> <p><b>P. 9</b></p>  <table border="1"> <thead> <tr><th>W</th><th>D</th></tr> </thead> <tbody> <tr><td>892</td><td>294</td></tr> <tr><td>1192</td><td>444</td></tr> <tr><td>1492**</td><td>594</td></tr> <tr><td>1792**</td><td>744</td></tr> <tr><td>2092**</td><td>894</td></tr> <tr><td>2392**</td><td>994</td></tr> </tbody> </table>	W	D	892	294	1192	444	1492**	594	1792**	744	2092**	894	2392**	994
300																																			
450																																			
600																																			
750																																			
900																																			
1000																																			
900																																			
1200																																			
1500																																			
1800																																			
2100*																																			
2400*																																			
450																																			
600																																			
750																																			
900																																			
1000																																			
W	D																																		
892	294																																		
1192	444																																		
1492**	594																																		
1792**	744																																		
2092**	894																																		
2392**	994																																		

\*Necesarios 2 travesaños de refuerzo por nivel / 2 Deck support required per level / 2 Barres de renfort requis par niveau

\*\* En 2 piezas / In 2 pieces / En 2 pièces

# kits bancos de trabajo / workbenches / Établis de travail

## BTP 900 / 1200 / 1500



### bancos de trabajo / work benches / bancs de travail

Artículo Item Article	Ref. Azul / Naranja Ref. Blue / Orange Ref. Bleu / Orange	Peso kg Weight kg Poids kg	Uds. paquete Units package Unités paquet	Dim. pakaging Dim. packaging Dim. d'emballage	Unidades palé Pallet units Unités palettes
BTP / 900	75030092	28,38	1	1500H x 600W x 70D	16
BTP / 1200	75030122	35,36	1	1500H x 600W x 70D	16
BTP / 1500	75030152	42,36	1	1500H x 600W x 70D	16

RAL 5010 Azul / Blue / Bleu RAL 2004 Naranja / Orange / Orange

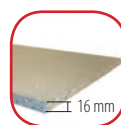
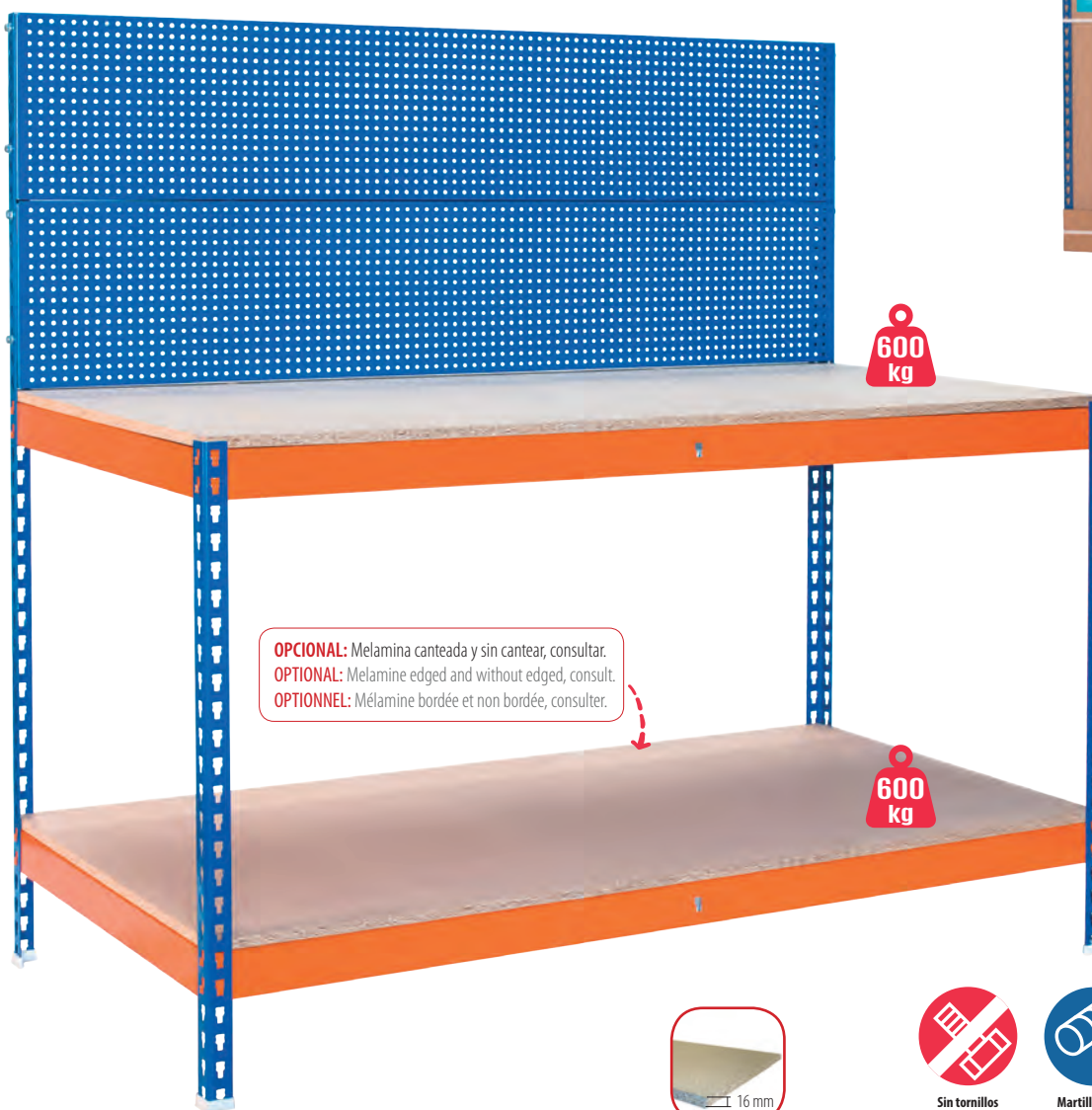

**Sin tornillos**  
Without bolts  
Sans vis



**Martillo nylon**  
Nylon hammer  
Marteau nylon



**Tiempo de montaje**  
Assembly time  
Temps d'assemblage

#### Instrucciones de montaje





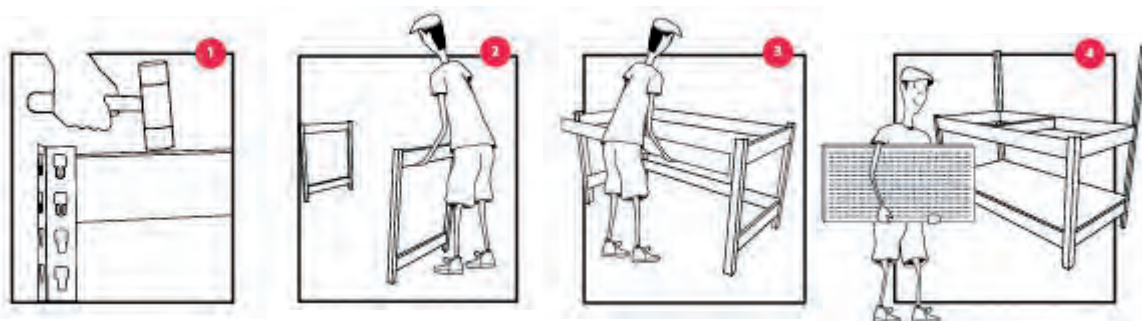



Assembly instructions

Instructions d'assemblage

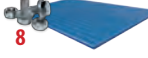

Unidades Units / Unités	
BTP / 900	
	2 888 mm 2 1480 mm
	4 35 x 35 mm
	4 600 mm
	4 900 mm
	2 600 mm
	2 892 x 594 mm
	2 900 x 300 mm
	8
	10

Unidades Units / Unités	
BTP / 900	
	2 888 mm 2 1480 mm
	4 35 x 35 mm
	4 600 mm
	4 1200 mm
	2 600 mm
	2 1192 x 594 mm
	2 1200 x 300 mm
	8
	10

Unidades Units / Unités	
BTP / 900	
	2 888 mm 2 1480 mm
	4 35 x 35 mm
	4 600 mm
	4 1500 mm
	2 600 mm
	2 1492 x 594 mm
	2 1500 x 300 mm
	8
	10

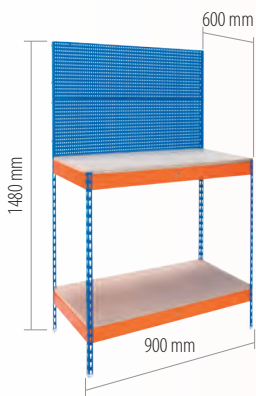

BTP 900

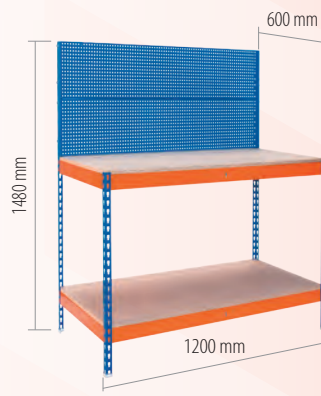



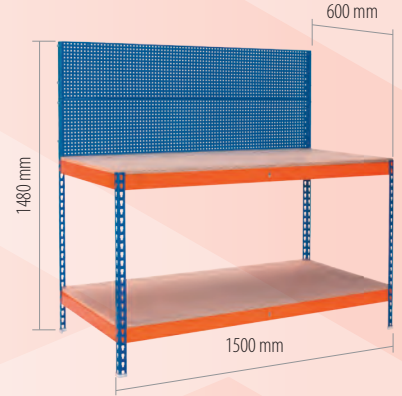



BTP 1200



BTP 1500

## Configure su banco de trabajo según su necesidad

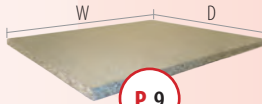
Configure your workbench as needed / Configurez votre établi de travail selon vos besoins

Perfil Upright Montant	Fondo "L" "L" Cross beam Lisse "L"	Larguero "C" "C" Beam Traverse C	Travesaño de refuerzo Deck support Barre de renfort	Aglomerado Chipboard Aggloméré	Panel Perforado Perfo panels panneaux porte-outils
					
<b>P. 20</b>	<b>P. 8</b>	<b>P. 8</b>	<b>P. 8</b>	<b>P. 9</b>	<b>P. 21</b>
888 1480	300 450 600 750 900 1000	900 1200 1500	450 600 750 900 1000 1200 1500	W 892 1192 1492*	D 294 444 594 744 894 994
					H 300 W 900 1200 1500

\* En 2 piezas / In 2 pieces / En 2 pièces

# kits bancos de trabajo / workbenches / Établis de travail

## BTE 900 / 1200 / 1500

### bancos de trabajo / work benches / bancs de travail

Artículo Item Article	Ref. Azul / Naranja Ref. Blue / Orange Réf. Bleu / Orange	Peso kg Weight kg Poids kg	Uds. paquete Units package Unités paquet	Dim. pakaging Dim. packaging Dim. d'emballage	Unidades palé Pallet units Unités palettes
BTE / 900	75030093	38,04	1	1500H x 750W x 70D	14
BTE / 1200	75030123	47,62	1	1500H x 750W x 70D	14
BTE / 1500	75030153	57,04	1	1500H x 750W x 70D	14

RAL 5010 Azul / Blue / Bleu RAL 2004 Naranja / Orange / Orange



**OPCIONAL:** Melamina canteada y sin cantear, consultar.  
**OPTIONAL:** Melamine edged and without edged, consult.  
**OPTIONNEL:** Méลามine bordée et non bordée, consulter.

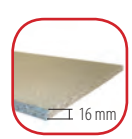



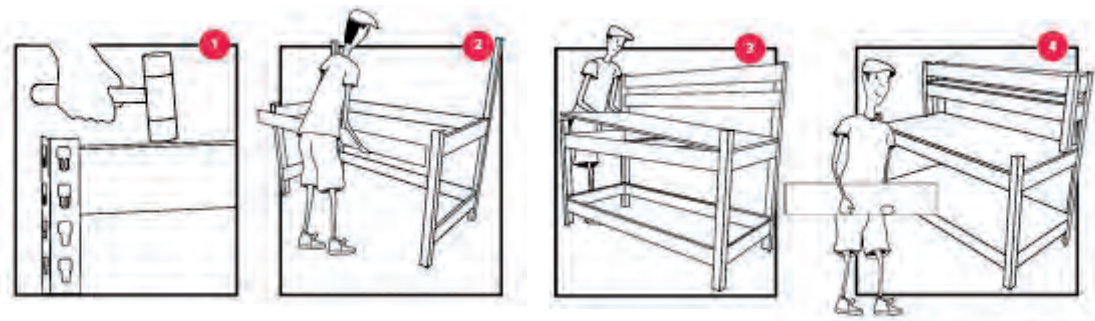



Instrucciones de montaje  
 Assembly instructions  
 Instructions d'assemblage



**Unidades**  
Units / Unités

**BTE / 900**

	2 592 mm 2 888 mm 2 1480 mm
	4 35 x 35 mm
	4 300 mm 4 750 mm
	8 900 mm
	2 750 mm
	2 892 x 294 mm 2 892 x 744 mm







**Unidades**  
Units / Unités

**BTE / 1200**

	2 592 mm 2 888 mm 2 1480 mm
	4 35 x 35 mm
	4 300 mm 4 750 mm
	8 1200 mm
	2 750 mm
	2 1192 x 294 mm 2 1192 x 744 mm

**Unidades**  
Units / Unités

**BTE / 1500**

	2 592 mm 2 888 mm 2 1480 mm
	4 35 x 35 mm
	4 300 mm 4 750 mm
	8 1500 mm
	2 750 mm
	2 1492 x 294 mm 2 1492 x 744 mm



**BTE 900**

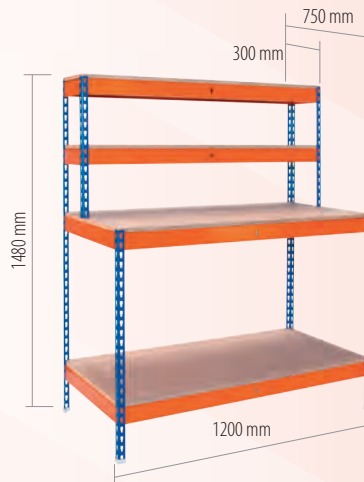



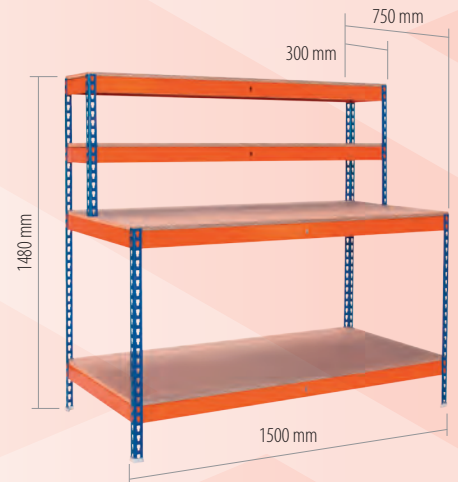

**BTE 1200**



**BTE 1500**

Configure su banco de trabajo según su necesidad  
Configure your workbench as needed / Configurez votre établi de travail selon vos besoins

Perfil Upright / Montant	Fondo "L" "L" Cross beam / Lisse	Larguero "C" "C" Beam / Traverse C	Travesaño de refuerzo Deck support / Barre de renfort	Aglomerado Chipboard / Aggloméré														
 <b>P. 20</b>	 <b>P. 8</b>	 <b>P. 8</b>	 <b>P. 8</b>	 <b>P. 9</b>														
592 888 1480	300 450 600 750 900 1000	900 1200 1500 1800 2100* 2400*	450 600 750 900 1000	<table border="1"> <thead> <tr> <th>W</th> <th>D</th> </tr> </thead> <tbody> <tr><td>892</td><td>294</td></tr> <tr><td>1192</td><td>444</td></tr> <tr><td>1492**</td><td>594</td></tr> <tr><td>1792**</td><td>744</td></tr> <tr><td>2092**</td><td>894</td></tr> <tr><td>2392**</td><td>994</td></tr> </tbody> </table>	W	D	892	294	1192	444	1492**	594	1792**	744	2092**	894	2392**	994
W	D																	
892	294																	
1192	444																	
1492**	594																	
1792**	744																	
2092**	894																	
2392**	994																	

\*Necesarios 2 travesaños de refuerzo por nivel / 2 Deck support required per level / 2 Barres de renfort requis par niveau

\*\* En 2 piezas / In 2 pieces / En 2 pièces

# Bancos de trabajo / workbenches / Établis de travail

Nuevo / New / Nouveau

muebles  
**INTERMOBEL**

J/35

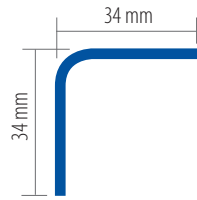
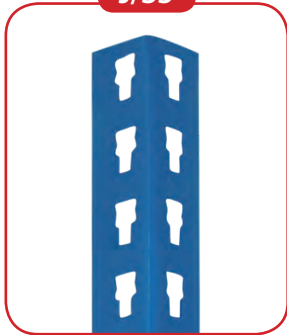

## Perfiles / Uprights / Montants

Artículo L Item L Article L	Ref. Naranja Ref. Orange Réf. Orange	Peso kg Weight kg Poids kg	Uds. Paquete Units Package Unités Paquet
J/35 de 592	73033506	0,44	2
J/35 de 814	73033508	0,58	2
J/35 de 888	73033509	0,66	2
J/35 de 1480	73033515	1,10	2

RAL 5010 Azul / Blue / Bleu



## Fondos "L-I" / "L-I" Cross beams / Traverses "L-I"

Artículo L - I Item L - I Article L - I	Ref. Naranja Ref. Orange Réf. Orange	Peso kg Weight kg Poids kg	Uds. Paquete Units Package Unités Paquet
L0300 / L - I	75045030	0,30	10
L0450 / L - I	75045045	0,45	10
L0600 / L - I	75045060	0,60	10
L0750 / L - I	75045075	0,75	10
L0900 / L - I	75045090	0,90	10
L1000 / L - I	75045100	1,00	10

RAL 2004 Naranja / Orange / Orange



Sin tornillos  
Without bolts  
Sans vis



Martillo nylon  
Nylon hammer  
Marteau nylon

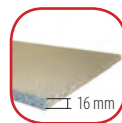

OPCIONAL: Melamina canteada y sin cantear, consultar.  
OPTIONAL: Melamine edged and without edged, consult.  
OPTIONNEL: Mélangine bordée et non bordée, consulter.





P. 20

Perfiles no incluidos, necesarios para sujeción a pared  
Uprights not included, necessary for wall mounting  
Montants non inclus, nécessaires pour le montage mural

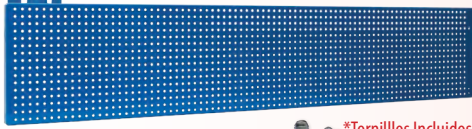

4uds.

## Paneles perforados / Perfo panels / Panneaux porte-outils

Artículo LxH Item LxP Article LxP	Ref. Azul Ref. Blue Réf. Bleu	Peso kg Weight kg Poids kg	Uds. Paquete Units Package Unités Paquet
900 x 300	75PP030903	2,90	2
1200 x 300	75PP031203	3,79	2
1500 x 300	75PP031503	4,69	2

RAL 5010 Azul / Blue / Bleu

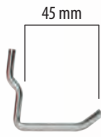

75GSC-ECO

20uds.



75GSC-405

10uds.

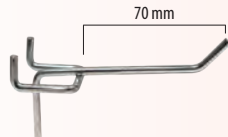

75GSC-410

10uds.

## Ganchos / Hooks / Crochets

Artículo Item Article	Referencia Referencia Referencia	Peso kg Weight kg Poids kg	Uds. Envase Units Pack Unités del emballage
45 - Ø 5	75GSC-ECO	0,28	20
20 - Ø 4	75GSC-405	0,18	10
70 - Ø 4	75GSC-410	0,23	10

GRUPO muebles **INTERMOBEL**

## Configure su banco de trabajo según su necesidad

Configure your workbench as needed / Configurez votre établi de travail selon vos besoins

Perfil  
Upright  
Montant

P. 20



592  
888  
1480

Fondo "L-I"  
"L - I" Cross beam  
Lisse "L - I"

P. 20



300  
450  
600  
750  
900  
1000

Fondo "L"  
"L" Cross beam  
Lisse "C"

P. 8



300  
450  
600  
750  
900  
1000

Larguero "C"  
"C" Beam  
Traverse "C"

P. 8



900  
1200  
1500  
1800  
2100\*  
2400\*

Travesaño de refuerzo  
Deck support  
Barre de renfort

P. 8



450  
600  
750  
900  
1000  
1200  
1500

Aglomerado  
Chipboard  
Aggloméré



P. 9

W	D
892	294
1192	444
1492**	594
1792**	744
2092**	894
2392**	944

Paneles perforados  
Perfo Panels  
Panneaux porte-outils

\*Tornillos Incluidos  
Screws included  
Vis incluses

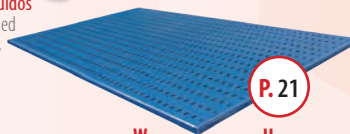

P. 21

W	H
900	300
1200	
1500	

Ganchos  
Hooks  
Crochets

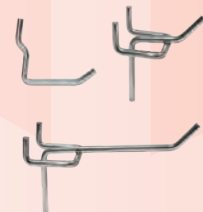

P. 21

\*Necesarios 2 travesaños de refuerzo por nivel / 2 Decks support required per level / 2 Barres de renfort requis par niveau

\*\*En 2 piezas / In 2 pieces / En 2 pièces

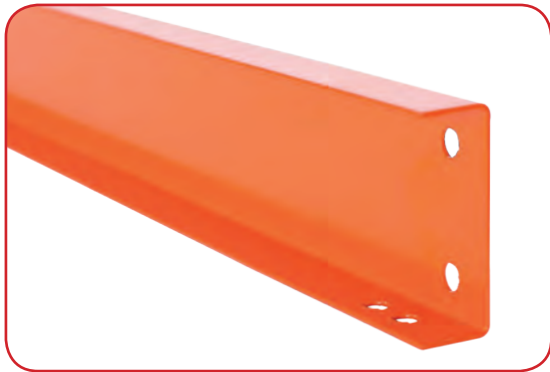

Ref. 75000037



Ref. 75000038



Ref. 75000036

**12 uds.**  
\*Tornillos incluidos  
Screws included  
Vis incluses

### Fondos y largueros "R"

Beams and Cross beams "R" / Traverses et Lisses "R"

Artículo L Item L Article L	Ref. Naranja Ref. Orange Réf. Orange	Peso kg Weight kg Poids kg	Uds. Paquete Units Package Unités Paquet
L0220 / R	75046030	0,28	2
L0370 / R	75046045	0,48	2
L0520 / R	75046060	0,67	2
L0670 / R	75046075	0,86	2
L0820 / R	75046090	1,05	2
L0920 / R	75046100	1,18	2
L1120 / R	75046120	1,44	2
L1420 / R	75046150	1,84	2
L1720 / R	75056180	2,65	2
L2020 / R	75046210	3,11	2
L2320 / R	75046240	3,57	2

RAL 2004 Naranja / Orange / Orange

### Rueda y adaptador / Wheel and adapter / roue et adaptateur

Artículo L Item L Article L	Ref. Naranja Ref. Orange Réf. Orange	Peso kg Weight kg Poids kg	Uds. Paquete Units Package Unités Paquet
Adaptador Rueda	75000036	0,24	4
Rueda 60 NYL	75000037	0,56	2
Rueda 60 FA NYL	75000038	0,63	2

**!** Carga máxima: 100 kg por rueda / Maximum load: 100 kg per wheel / Charge maximale: 100 kg par roue



**OPCIONAL:** Melamina canteada y sin cantear, consultar.  
**OPTIONAL:** Melamine edged and without edged, consult.  
**OPTIONNEL:** Mèlamine bordée et non bordée, consulter.





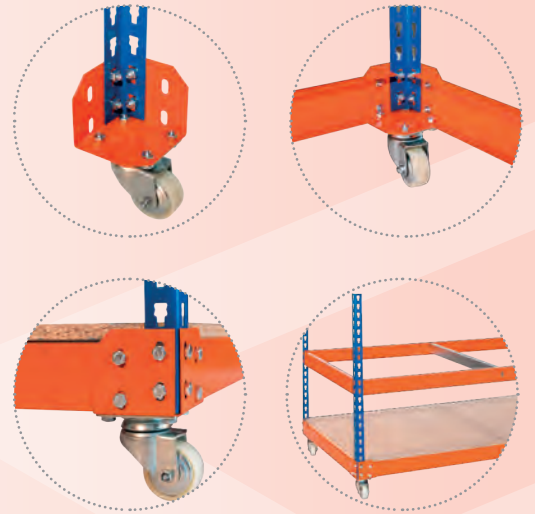





Martillo nylon  
Nylon hammer  
Marteau nylon



GRUPO **INTERMOBEL**

Configure su banco de trabajo según su necesidad  
Configure your workbench as needed / Configurez votre établi de travail selon vos besoins

<p><b>Perfil</b> Upright Montant</p> <p><b>P. 20</b></p>  <p>814</p>	<p><b>Adaptador ruedas</b> Wheel adapter Adaptateur de roue</p> <p><b>P. 22</b></p> 	<p><b>Ruedas</b> wheels roues</p> <p><b>P. 22</b></p> 	<p><b>Fondo "R"</b> "R" Cross beam Lisse "R"</p> <p><b>P. 22</b></p>  <table border="0"> <tr><td>220</td></tr> <tr><td>370</td></tr> <tr><td>520</td></tr> <tr><td>670</td></tr> <tr><td>820</td></tr> <tr><td>920</td></tr> </table>	220	370	520	670	820	920	<p><b>Larguero "R"</b> "R" Beam Traverse "R"</p> <p><b>P. 22</b></p>  <table border="0"> <tr><td>820</td></tr> <tr><td>1120</td></tr> <tr><td>1420</td></tr> <tr><td>1720</td></tr> <tr><td>2020*</td></tr> <tr><td>2320*</td></tr> </table>	820	1120	1420	1720	2020*	2320*																		
220																																		
370																																		
520																																		
670																																		
820																																		
920																																		
820																																		
1120																																		
1420																																		
1720																																		
2020*																																		
2320*																																		
<p><b>Fondo "L"</b> "L" Cross beam Lisse "C"</p> <p><b>P. 8</b></p>  <table border="0"> <tr><td>300</td></tr> <tr><td>450</td></tr> <tr><td>600</td></tr> <tr><td>750</td></tr> <tr><td>900</td></tr> <tr><td>1000</td></tr> </table>	300	450	600	750	900	1000	<p><b>Larguero "C"</b> "C" Beam Traverse "C"</p> <p><b>P. 8</b></p>  <table border="0"> <tr><td>900</td></tr> <tr><td>1200</td></tr> <tr><td>1500</td></tr> <tr><td>1800</td></tr> <tr><td>2100*</td></tr> <tr><td>2400*</td></tr> </table>	900	1200	1500	1800	2100*	2400*	<p><b>Travesaño de refuerzo</b> Deck support Barre de renfort</p> <p><b>P. 8</b></p>  <table border="0"> <tr><td>450</td></tr> <tr><td>600</td></tr> <tr><td>750</td></tr> <tr><td>900</td></tr> <tr><td>1000</td></tr> </table>	450	600	750	900	1000	<p><b>Aglomerado</b> Chipboard Aggloméré</p> <p><b>P. 9</b></p>  <table border="0"> <thead> <tr> <th>W</th> <th>D</th> </tr> </thead> <tbody> <tr><td>892</td><td>294</td></tr> <tr><td>1192</td><td>444</td></tr> <tr><td>1492**</td><td>594</td></tr> <tr><td>1792**</td><td>744</td></tr> <tr><td>2092**</td><td>894</td></tr> <tr><td>2392**</td><td>944</td></tr> </tbody> </table>	W	D	892	294	1192	444	1492**	594	1792**	744	2092**	894	2392**	944
300																																		
450																																		
600																																		
750																																		
900																																		
1000																																		
900																																		
1200																																		
1500																																		
1800																																		
2100*																																		
2400*																																		
450																																		
600																																		
750																																		
900																																		
1000																																		
W	D																																	
892	294																																	
1192	444																																	
1492**	594																																	
1792**	744																																	
2092**	894																																	
2392**	944																																	

\*Necesarios 2 travesaños de refuerzo por nivel / 2 Decks support required per level / 2 Barres de renfort requis par niveau

\*\*En 2 piezas / In 2 pieces / En 2 pièces



**Media Carga**, almacenamiento para cargas voluminosas .  
Diseñado para carga manual en entornos industriales, comerciales  
y minoristas.

**Heavy-Duty Racking**, Storage for bulky loads. Designed for  
manual loading in industrial, commercial and retail settings.

**Charges Mi-lourd**, stockage pour charges volumineuses. Conçu  
pour le chargement manuel dans les environnements industriels,  
commerciaux et de vente au détail.

**\*Altura libre de pandeo (distancia entre el suelo y el primer nivel)**

\*Clearance height (distance from floor to first level)

\*Hauteur libre de flambage (distance entre le sol et le premier niveau)

<b>h* (mm)</b>	1000	1400	1800	2000
<b>Kg**</b>	5000	4800	3300	2600

**\*\*Carga Admisible / Allowable load / Charge admissible**



<b>longitud (mm)</b>	<b>L/900</b>	<b>L/1200</b>	<b>L/1500</b>	<b>L/1800</b>	<b>L/2100</b>	<b>L/2400</b>
length (mm)	1430 kg	1150 kg	900 kg	750 kg	575 kg	425 kg
Longueur (mm)						



**Bastidor** / Upright / Échelle



**Larguero** / Beam / Lisse



**Perno de seguridad**  
Safety pin  
Goupille de sécurité

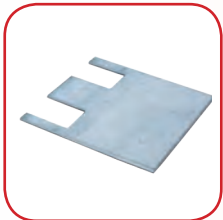

**Pletina**  
Levelling  
Plaque de calage



**Travesaño aglomerado**  
Chipboard cross member  
Traverse bois

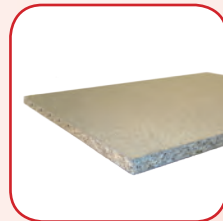

**Aglomerado**  
Chipboard  
Aggloméré

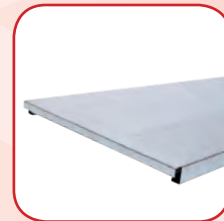

**Balda galvanizada**  
Galvanised shelf  
Tablette galvanisée



**Anclaje** / Anchor / Ancre



**Unión bifrontal**  
Bi-frontal attachment  
Union d'échelle



**Unión a pared**  
Attachment to wall  
Fixation au mur

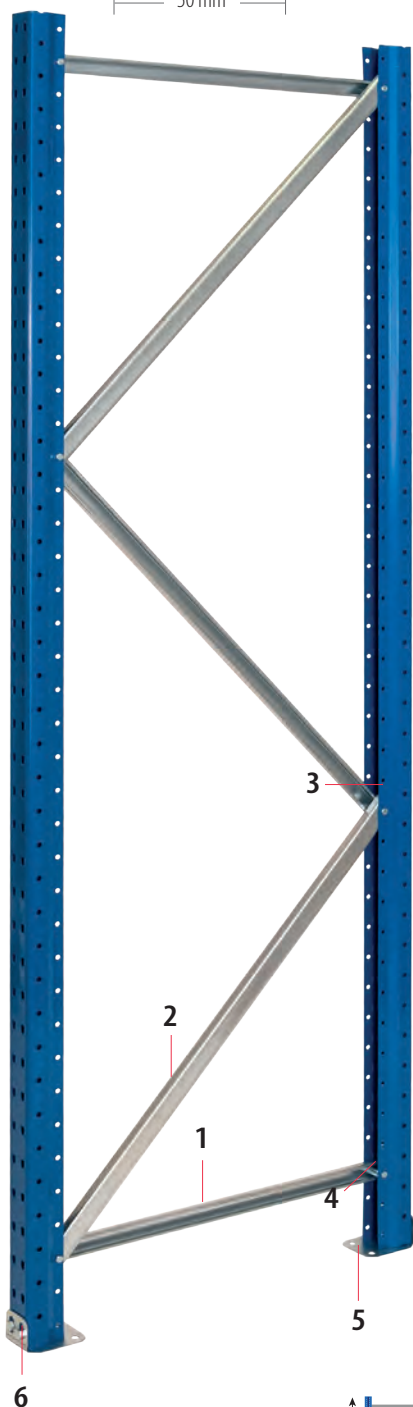
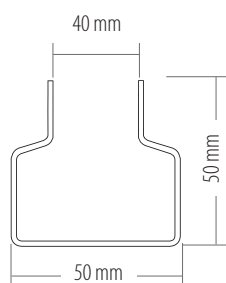

## Bastidor / Upright / Échelle

Artículo HxP Item HxD Article HxP	Referencia Reference Référence	Peso kg Weight kg Poids kg	Uds. Paquete Units package Unités par paquet
2000 x 400	59002004	8,80	1
2000 x 500	59002005	9,00	1
2000 x 600	59002006	9,20	1
2000 x 800	59002008	9,60	1
2000 x 1000	59002010	10,00	1
2000 x 1200	59002012	10,50	1
2500 x 400	59002504	10,60	1
2500 x 500	59002505	10,80	1
2500 x 600	59002506	11,00	1
2500 x 800	59002508	11,40	1
2500 x 1000	59002510	11,90	1
2500 x 1200	59002512	12,40	1
3000 x 400	59003004	12,80	1
3000 x 500	59003005	13,00	1
3000 x 600	59003006	13,30	1
3000 x 800	59003008	13,80	1
3000 x 1000	59003010	14,30	1
3000 x 1200	59003012	14,90	1

RAL 5156 Azul / Blue / Bleu

Galvanizado / Galvanized / Galvanisée

## Componentes Bastidor / Upright components / Composants d'échelle

Altura Height Hauteur	Horizontales <sup>1</sup> Horizontal Horizontale	Diagonales <sup>2</sup> Diagonal Diagonale	Tornillo M6x40 <sup>3</sup> Screw M6x40 Vis M6x40	Casquillo <sup>4</sup> bushing douille	Pié Metálico <sup>5</sup> Metal foot Pied métallique	Tornillo M8x20 <sup>6</sup> Screw M8x20 Vis M8x20
1000	3	1	6	4	2	4
1500	2	2	5	2	2	4
2000	2	3	6	2	2	4
2500	3	3	8	4	2	4
3000	3	4	9	4	2	4

## Medidas de las Dagonales y horizontales

Horizontal and diagonal measurements / Mesures horizontales et diagonales

Profundidad / Depth / Profondeur	400	500	600	800	1000	1200
Horizontales / Horizontal / Horizontale	348	448	548	748	948	1148
Diagonales / Diagonal / Diagonale	713	765	825	968	1125	1303

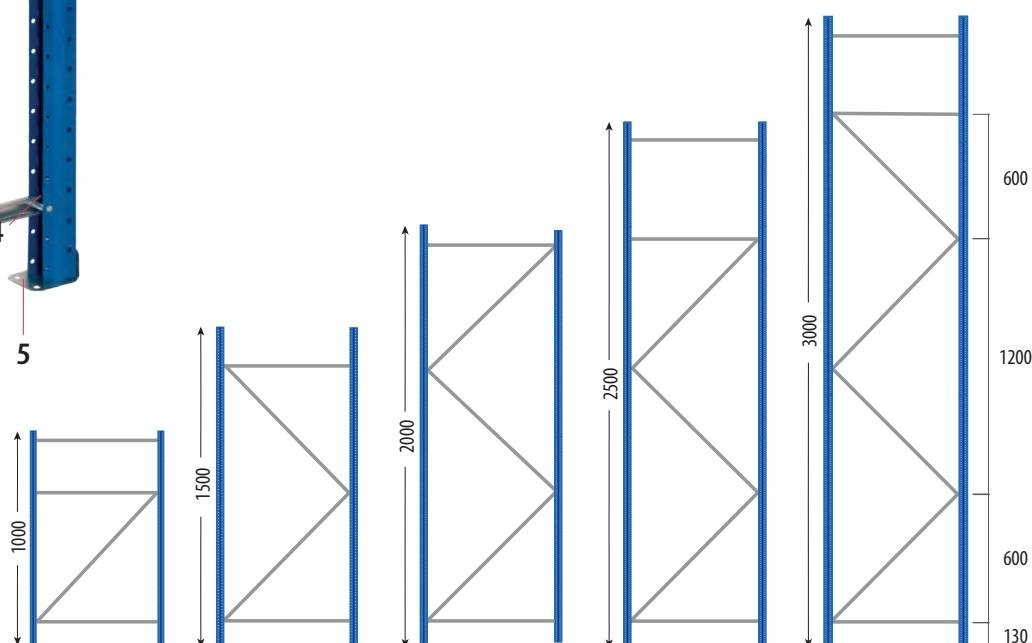

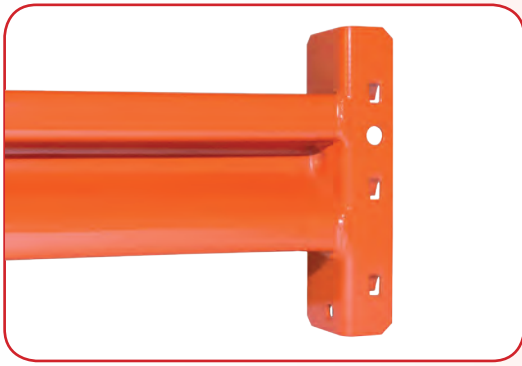
**Largueros /** Beams / Lisses

Artículo L Item L Article L	Referencia Reference Référence	Peso kg Weight kg Poids kg	Uds. Paquete Units package Unités paquet
Z80 x 30 / 900	59008409	2,00	2
Z80 x 30 / 1200	59008412	2,51	2
Z80 x 30 / 1500	59008415	3,02	2
Z80 x 30 / 1800	59008418	3,53	2
Z80 x 30 / 2100	59008421	4,04	2
Z80 x 30 / 2400	59008424	4,55	2

RAL 2154 Naranja / Orange / Orange

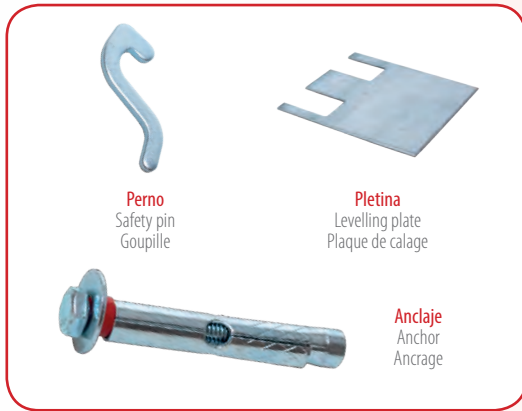
**Accesorios /** Accessories / Accessoires

Artículo Item Article	Referencia Reference Référence	Peso kg Weight kg Poids kg	Uds. Paquete Units package Unités paquet
Perno de seguridad / Larguero Safety pin / Beam Goupille de sécurité / Lisse	59000001	0,01	2
Pletina de nivelación 1,5 mm Levelling plate 1,5 mm Plaques de calage 1,5 mm	59000008	0,05	2
M6 x 60/9 anclaje / Suelo M6 x 60/9 Anchor / Floor Ancrage M6 x 60/9 / Sol	59000034	0,02	2

Galvanizado / Galvanized / Galvanisée

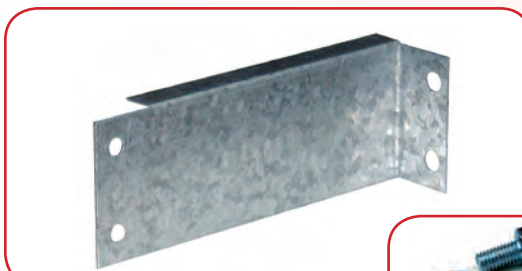

Tornillería incluida / Screws included / Vis incluses

**Uniones /** Attachment / Unions

Artículo Item Article	Referencia Reference Référence	Peso kg Weight kg Poids kg	Uds. Paquete Units package Unités paquet
Unión a pared 100 mm Attachment to wall 100 mm Fixation au mur 100 mm	59000036	0,24	1
Unión a pared 200 mm Attachment to wall 200 mm Fixation au mur 200 mm	59000038	0,38	1
Unión a pared 300 mm Attachment to wall 300 mm Fixation au mur 300 mm	59000040	0,52	1
Unión bifrontal 100 mm Bi-frontal attachment 100 mm Union bifrontale 100 mm	59000046	0,27	1
Unión bifrontal 200 mm Bi-frontal attachment 200 mm Union bifrontale 200 mm	59000047	0,41	1
Unión bifrontal 300 mm Bi-frontal attachment 300 mm Union bifrontale 300 mm	59000048	0,55	1

Galvanizado / Galvanized / Galvanisée

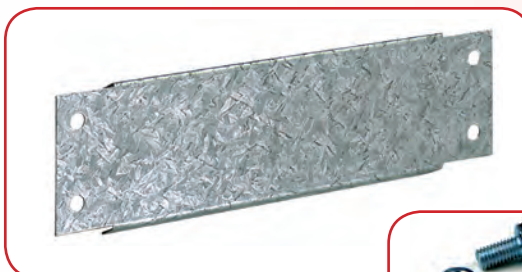

Tornillería incluida / Screws included / Vis incluses



muebles  
**INTERMOBEL**

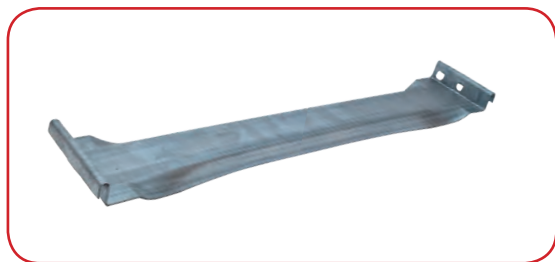

## Travesaños / Cross members / Traverses

Artículo L Item L Article L	Referencia Reference Référence	Peso kg Weight kg Poids kg	Uds. Paquete Units package Unités paquet
400	59000055	0,40	1
500	59000056	0,48	1
600	59000057	0,56	1
800	59000058	0,72	1
1000	59000059	0,88	1
1200	59000060	1,04	1

Galvanizado / Galvanized / Galvanisée

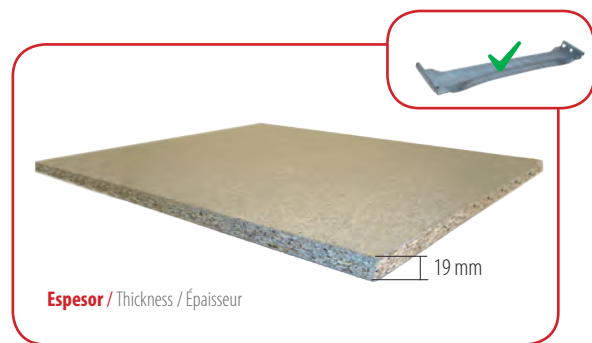

## Aglomerado 1 pieza / Chipboard 1 item / Aggloméré 1 pièce

Para niveles con travesaño / For shelves with cross members / Pour étagères avec traverse

Artículo LxP Item LxD Article LxP	Referencia Reference Référence	Peso kg Weight kg Poids kg	Uds. Paquete Units Package Unités par paquet
894 x 385	59089038	4,03	1
894 x 485	59089048	5,10	1
894 x 585	59089058	6,17	1
894 x 785	59089078	8,30	1
894 x 985	59089098	10,44	1
894 x 1185	59089118	12,57	1
1194 x 385	59119038	5,46	1
1194 x 485	59119048	6,88	1
1194 x 585	59119058	8,30	1
1194 x 785	59119078	11,15	1
1194 x 985	59119098	13,99	1
1194 x 1185	59119118	16,72	1

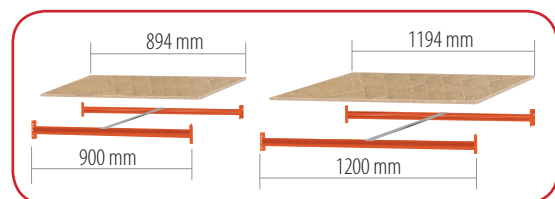

## Aglomerado 2 piezas / Chipboard 2 items / Aggloméré 2 pièces

Para niveles con travesaño /

Artículo LxP Item LxD Article LxP	Referencia Reference Référence	Peso kg Weight kg Poids kg	Uds. Paquete Units Package Unités par paquet
747 + 747 x 385	59149038	6,88	1 + 1
747 + 747 x 485	59149048	8,54	1 + 1
747 + 747 x 585	59149058	10,32	1 + 1
747 + 747 x 785	59149078	13,88	1 + 1
747 + 747 x 985	59149098	17,43	1 + 1
747 + 747 x 1185	59149118	20,99	1 + 1
897 + 897 x 385	59179038	8,18	1 + 1
897 + 897 x 485	59179048	10,32	1 + 1
897 + 897 x 585	59179058	12,45	1 + 1
897 + 897 x 785	59179078	16,72	1 + 1
897 + 897 x 985	59179098	20,99	1 + 1
897 + 897 x 1185	59179118	25,26	1 + 1
1047 + 1047 x 385	59209038	9,61	1 + 1
1047 + 1047 x 485	59209048	12,10	1 + 1
1047 + 1047 x 585	59209058	14,47	1 + 1
1047 + 1047 x 785	59209078	19,45	1 + 1
1047 + 1047 x 985	59209098	24,43	1 + 1
1047 + 1047 x 1185	59209118	29,41	1 + 1
1197 + 1197 x 385	59239038	10,91	1 + 1
1197 + 1197 x 485	59239048	13,76	1 + 1
1197 + 1197 x 585	59239058	16,60	1 + 1
1197 + 1197 x 785	59239078	22,30	1 + 1
1197 + 1197 x 985	59239098	27,99	1 + 1
1197 + 1197 x 1185	59239118	33,68	1 + 1

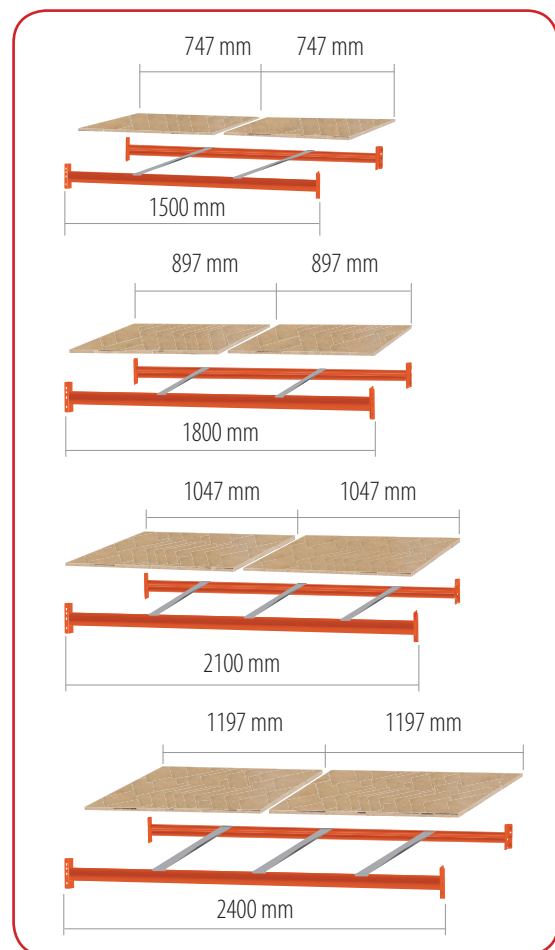



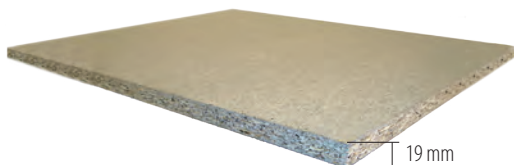

Espesor / Thickness / Épaisseur

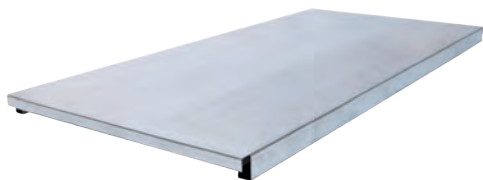
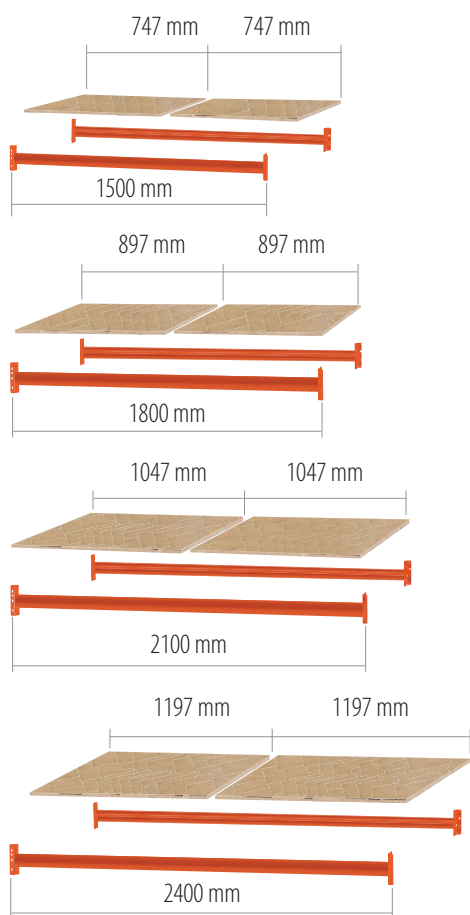
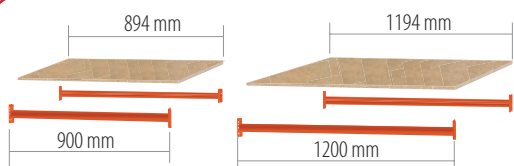
**Aglomerado 1 pieza /** Chipboard 1 item / Aggloméré 1 pièce

Para niveles sin travesaño /

	<b>Artículo LxP</b>	<b>Referencia</b>	<b>Peso kg</b>	<b>Uds. Paquete</b>
	Item LxD Article LxP	Reference Référence	Weight kg Poids kg	Units Package Unités par paquet
900 mm	894 x 395	59089039	4,15	1
	894 x 495	59089049	5,22	1
	894 x 595	59089059	6,29	1
	894 x 795	59089079	8,42	1
	894 x 995	59089099	10,56	1
	894 x 1195	59089119	12,69	1
1200 mm	1194 x 395	59119039	5,57	1
	1194 x 495	59119049	7,00	1
	1194 x 595	59119059	8,42	1
	1194 x 795	59119079	11,27	1
	1194 x 995	59119099	14,11	1
	1194 x 1195	59119119	16,96	1

**Aglomerado 2 piezas /** Chipboard 2 items / Aggloméré 2 pièces

Para niveles sin travesaño /

	<b>Artículo LxP</b>	<b>Referencia</b>	<b>Peso kg</b>	<b>Uds. Paquete</b>
	Item LxD Article LxP	Reference Référence	Weight kg Poids kg	Units Package Unités par paquet
1500 mm	747 + 747 x 395	59149039	7,00	1 + 1
	747 + 747 x 495	59149049	8,78	1 + 1
	747 + 747 x 595	59149059	10,56	1 + 1
	747 + 747 x 795	59149079	14,11	1 + 1
	747 + 747 x 995	59149099	17,67	1 + 1
	747 + 747 x 1195	59149119	21,23	1 + 1
1800 mm	897 + 897 x 395	59179039	8,42	1 + 1
	897 + 897 x 495	59179049	10,56	1 + 1
	897 + 897 x 595	59179059	12,69	1 + 1
	897 + 897 x 795	59179079	16,96	1 + 1
	897 + 897 x 995	59179099	21,23	1 + 1
	897 + 897 x 1195	59179119	25,38	1 + 1
2100 mm	1047 + 1047 x 395	59209039	9,84	1 + 1
	1047 + 1047 x 495	59209049	12,33	1 + 1
	1047 + 1047 x 595	59209059	14,83	1 + 1
	1047 + 1047 x 795	59209079	19,69	1 + 1
	1047 + 1047 x 995	59209099	24,67	1 + 1
	1047 + 1047 x 1195	59209119	29,65	1 + 1
2400 mm	1197 + 1197 x 395	59239039	11,27	1 + 1
	1197 + 1197 x 495	59239049	14,11	1 + 1
	1197 + 1197 x 595	59239059	16,84	1 + 1
	1197 + 1197 x 795	59239079	22,53	1 + 1
	1197 + 1197 x 995	59239099	28,23	1 + 1
	1197 + 1197 x 1195	59239119	33,92	1 + 1

**Baldas /** Shelves / Tablettes

<b>Artículo L</b>	<b>Referencia</b>	<b>Peso kg</b>	<b>Uds. Paquete</b>
Item L Article L	Reference Référence	Weight kg Poids kg	Units package Unités paquet
400 x 300	59090403	0,67	10
500 x 300	59090503	0,84	10
600 x 300	59090603	1,01	10
800 x 300	59090803	1,35	10
1000 x 300	59091003	1,69	10
1200 x 300	59091203	2,03	10

Galvanizado / Galvanized / Galvanisée



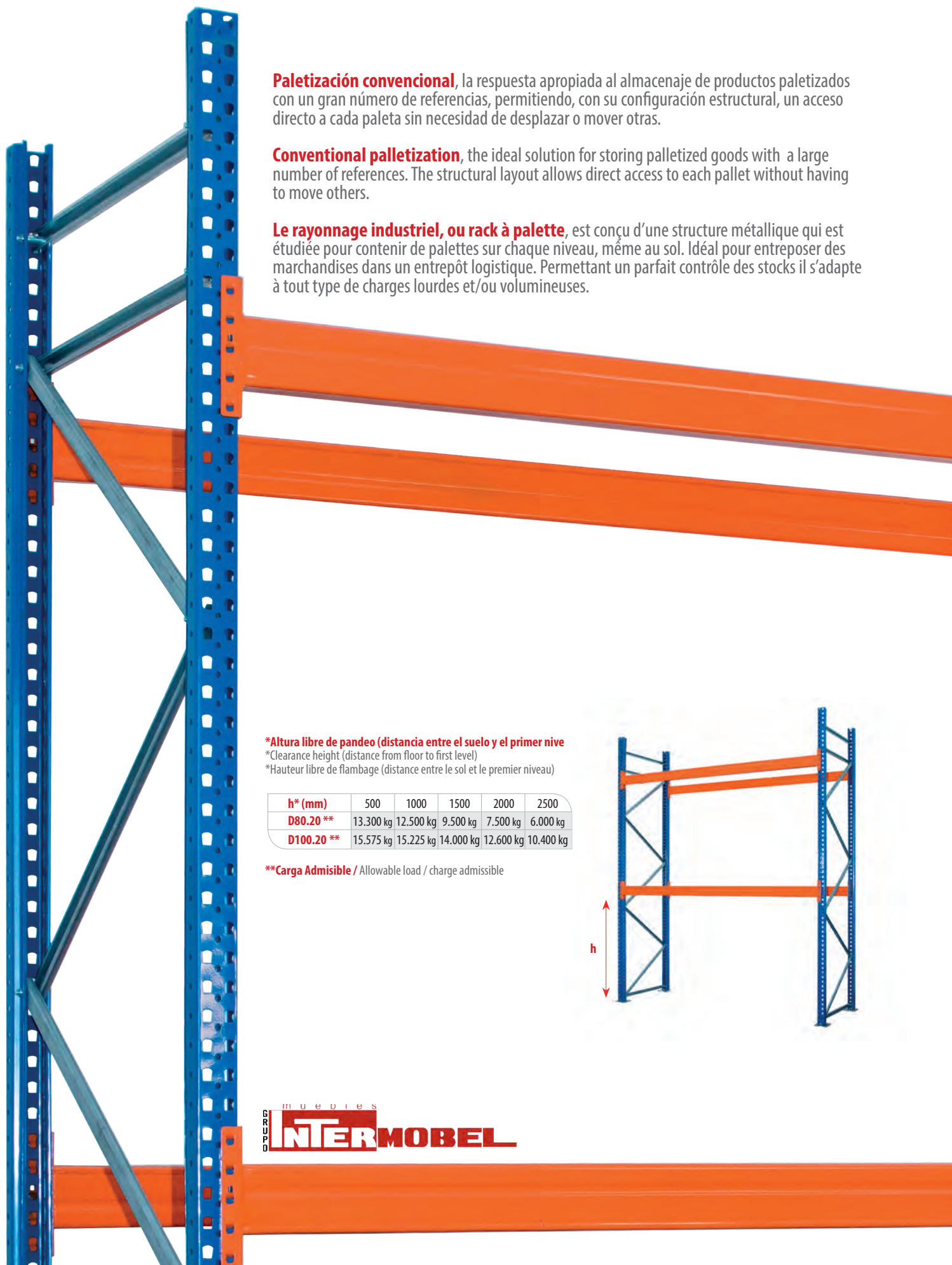

**Paletización convencional**, la respuesta apropiada al almacenaje de productos paletizados con un gran número de referencias, permitiendo, con su configuración estructural, un acceso directo a cada paleta sin necesidad de desplazar o mover otras.

**Conventional palletization**, the ideal solution for storing palletized goods with a large number of references. The structural layout allows direct access to each pallet without having to move others.

**Le rayonnage industriel, ou rack à palette**, est conçu d'une structure métallique qui est étudiée pour contenir de palettes sur chaque niveau, même au sol. Idéal pour entreposer des marchandises dans un entrepôt logistique. Permettant un parfait contrôle des stocks il s'adapte à tout type de charges lourdes et/ou volumineuses.

**\*Altura libre de pandeo (distancia entre el suelo y el primer nivel)**

\*Clearance height (distance from floor to first level)

\*Hauteur libre de flambage (distance entre le sol et le premier niveau)

h* (mm)	500	1000	1500	2000	2500
<b>D80.20 **</b>	13.300 kg	12.500 kg	9.500 kg	7.500 kg	6.000 kg
<b>D100.20 **</b>	15.575 kg	15.225 kg	14.000 kg	12.600 kg	10.400 kg

**\*\*Carga Admisible / Allowable load / charge admissible**

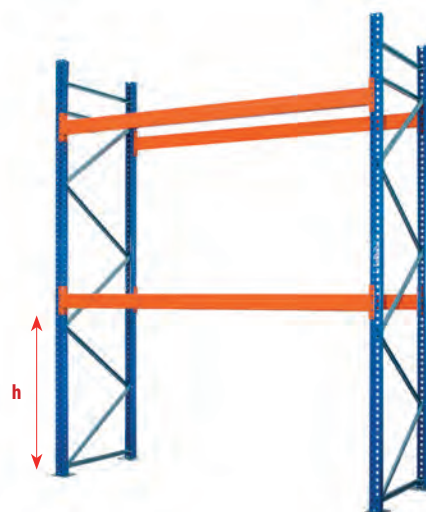

muebles  
**INTERMOBEL**

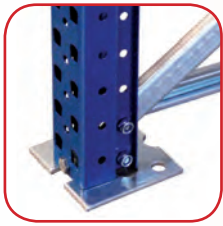

**Bastidor** / Upright / Échelle



**Larguero** / Beam / Lisse



**Perno de seguridad**  
Safety pin  
Goupille de sécurité

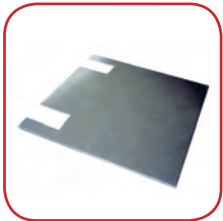

**Pletina**  
Levelling / Plaque de calage



**Anclaje** / Anchor / Ancrage



muebles  
**INTERMOBEL**



**Unión bifrontal**  
Bi-frontal attachment  
Union d'échelle



**Travesaño exterior aglomerado**  
External chipboard cross member  
Traverse bois



**Travesaño interior paleta**  
Internal palletcross member  
Traverse palette



**Protección bastidor**  
Upright protection  
Protection échelle



**Protección lateral**  
Side protection  
Protection latérale



**Anclaje protector bastidor**  
Anchor protector upright  
Ancrage protection échelle

# Paletización convencional / Pallet Racking / Rack à palette

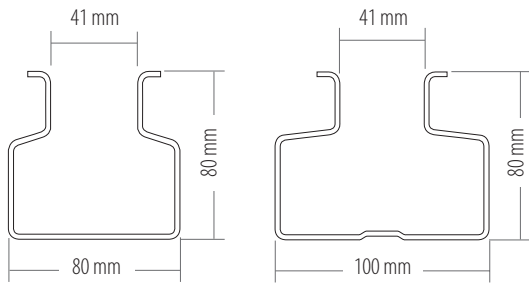

GRUPO **INTERMOBEL**

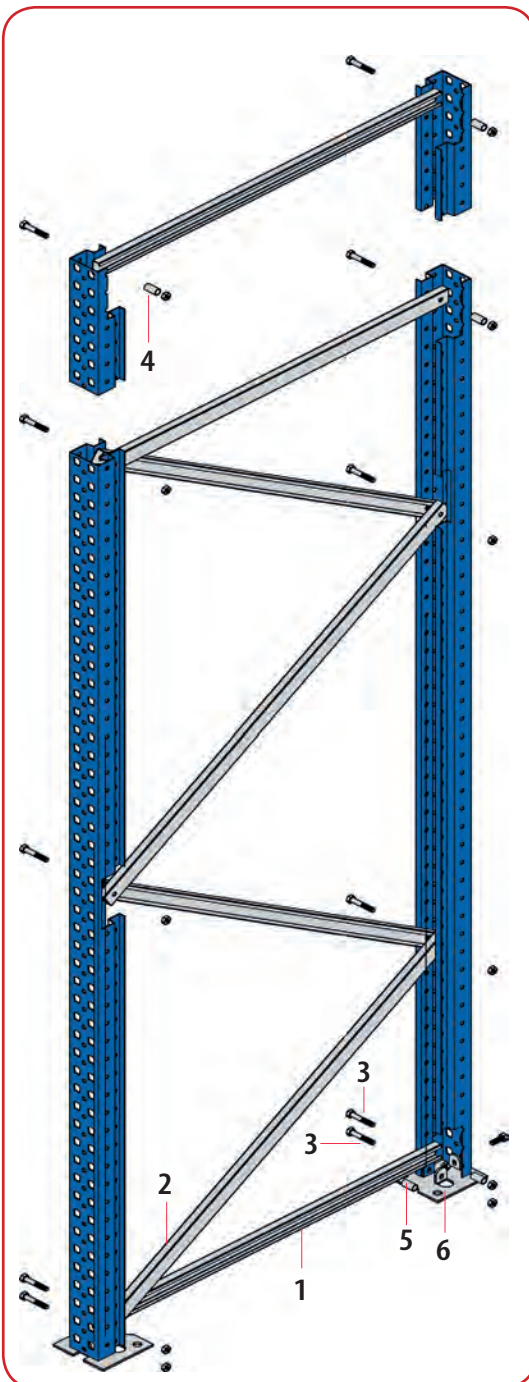

## Bastidor D80.20 / D80.20 Upright / Échelle D80.20

Artículo HxD Item HxD Article HxP	Referencia Reference Référence	Peso kg Weight kg Poids kg	Uds. Paquete Units package Unités par paquet
2000 x 1050	77021121	24,56	1
2500 x 1050	77021122	29,84	1
3000 x 1050	77021124	35,03	1
3500 x 1050*	77021126	40,31	1
4000 x 1050*	77021127	44,49	1
4500 x 1050*	77021129	49,77	1
5000 x 1050*	77021131	55,06	1
5500 x 1050*	77021132	60,34	1
6000 x 1050*	77021134	65,53	1

RAL 5010 azul / Blue / Bleu

Galvanizado / Galvanized / Galvanisée

## Bastidor D100.20 / D100.20 Upright / Échelle D100.20

Artículo HxD Item HxD Article HxP	Referencia Reference Référence	Peso kg Weight kg Poids kg	Uds. Paquete Units package Unités paquet
4000 x 1050*	77021055	49,26	1
4500 x 1050*	77021057	55,14	1
5000 x 1050*	77021059	61,02	1
5500 x 1050*	77021060	66,90	1
6000 x 1050*	77021062	72,90	1

RAL 5010 azul / Blue / Bleu

Galvanizado / Galvanized / Galvanisée

## Componentes Bastidor / Upright components / Composants d'échelle

Altura Height Hauteur	Horizontales <sup>1</sup> Horizontal Horizontale	Diagonales <sup>2</sup> Diagonal Diagonale	Tornillo M10x60 <sup>3</sup> Screw M10x60 Vis M10x60	Casquillo <sup>4/5</sup> bushing douille	Pié Metálico <sup>6</sup> Metal foot Pied métallique	Tornillo M10x20 <sup>7</sup> Screw M10x20 Vis M10x20
2000	2	3	8	2 2 41 38	2	2
2500	2	4	9	2 2	2	2
3000	3	4	11	2 4	2	2
3500	3	5	12	2 4	2	2
4000	2	6	11	2 2	2	2
4500	2	7	12	2 2	2	2
5000	2	8	13	2 2	2	2
5500	2	9	14	2 2	2	2
6000	3	9	16	2 4	2	2

**Bastidores en fondo 700 y 850, consultar**  
Uprights with 700 and 850 depth, please consult  
Échelle profondeur 700 et 850 à consulter

- 1 Horizontal / Horizontal / Horizontale**
- 2 Diagonal / Diagonal / Diagonale**
- 3 Tornillo M10 x 60 DIN-933.8.8 / Bolt / Boulon**  
**Tuerca M10 DIN-985.8 / Nut / Écrou**
- 4 Casquillo Ø 16/13 L= 38 mm / bushing / douille**
- 5 Casquillo Ø 16/13 L= 28 mm / bushing / douille**
- 6 Pie metálico / Footplate / Pied métallique**
- 7 Tornillo M10 x 20 DIN-933.8.8 / Bolt / Boulon**  
**Tuerca M10 DIN-934.8 / Nut / Écrou**

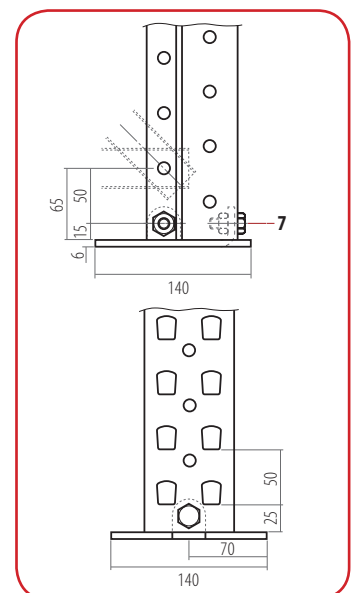

\*En **Bastidores y largueros** con longitud superior a 3 metros se aplicará un suplemento de transporte del 6% sobre tarifa base, con un mínimo de 50€.

\*In **Uprights and beams** with a length greater than 3 meters, a transport supplement of 6% will be applied on the base rate, with a minimum of € 50.

\* Dans les **Échelles et lisses** d'une longueur supérieure à 3 mètres, un supplément transport de 6% sera appliqué sur le tarif de base, avec un minimum de 50 €.



## Larguero CC2 / CC2 beam / Lisse CC2

Artículo L Item L Article L	Referencia Reference Référence	Peso kg Weight kg Poids kg	Uds. Paquete Units package Unités paquet
CC2 80 / 1825	77010029	9,35	2
CC2 100 / 1825	77010104	10,20	2
CC2 80 / 2225	77010030	11,06	2
CC2 100 / 2225	77010105	12,11	2
CC2 80 / 2700	77010031	13,10	2
CC2 100 / 2700	77010106	14,37	2
CC2 120 / 2700	77010256	15,63	2
CC2 145 / 2700	77010257	17,22	2
CC2 145 / 3300*	77010258	20,71	2

RAL 2004 Naranja / Orange / Orange

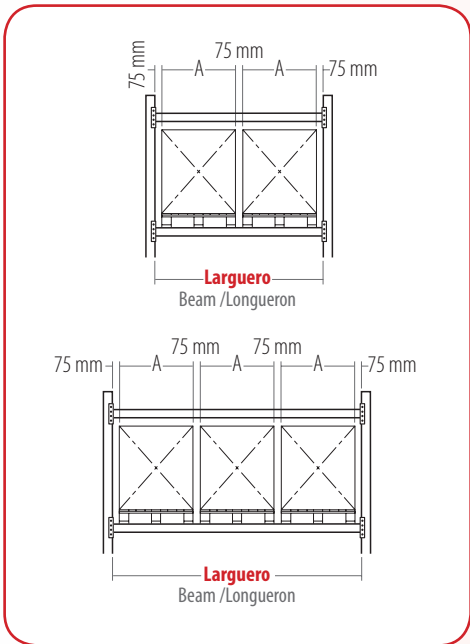
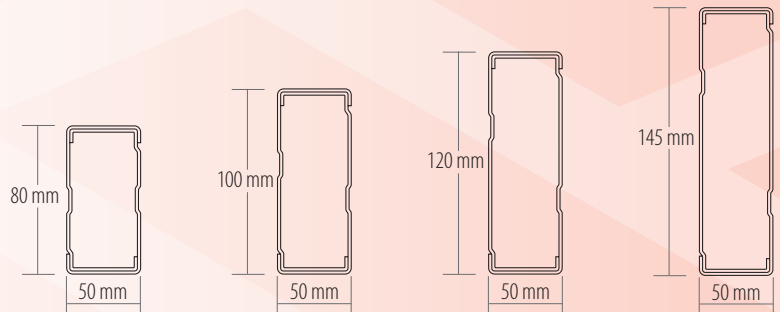

Larguero Beam Lisse	L / 1825	L / 2225	L / 2700	L / 3300
CC2 80	2600 kg	2200 kg	1900 kg	-
CC2 100	3200 kg	3000 kg	2500 kg	-
CC2 120	-	-	2900 kg	-
CC2 145	-	-	3900 kg	3300 kg

Capacidad de carga por par de largueros / Load capacity per pair of beams / Capacité de charge par couple de longuerons

Nº de paletas No. of pallets Nº de palettes	Paleta Palet / Palette (A) 800 x 1200	Paleta Palet / Palette (A) 1000 x 1200	Paleta Palet / Palette (A) 1200 x 1200
2	(L) 1825	(L) 2225	(L) 2700
3	(L) 2700	(L) 3300	-

(L) Longitud larguero / (L) Length of beam / (L) Longueur du longueron

muebles  
**INTERMOBEL**

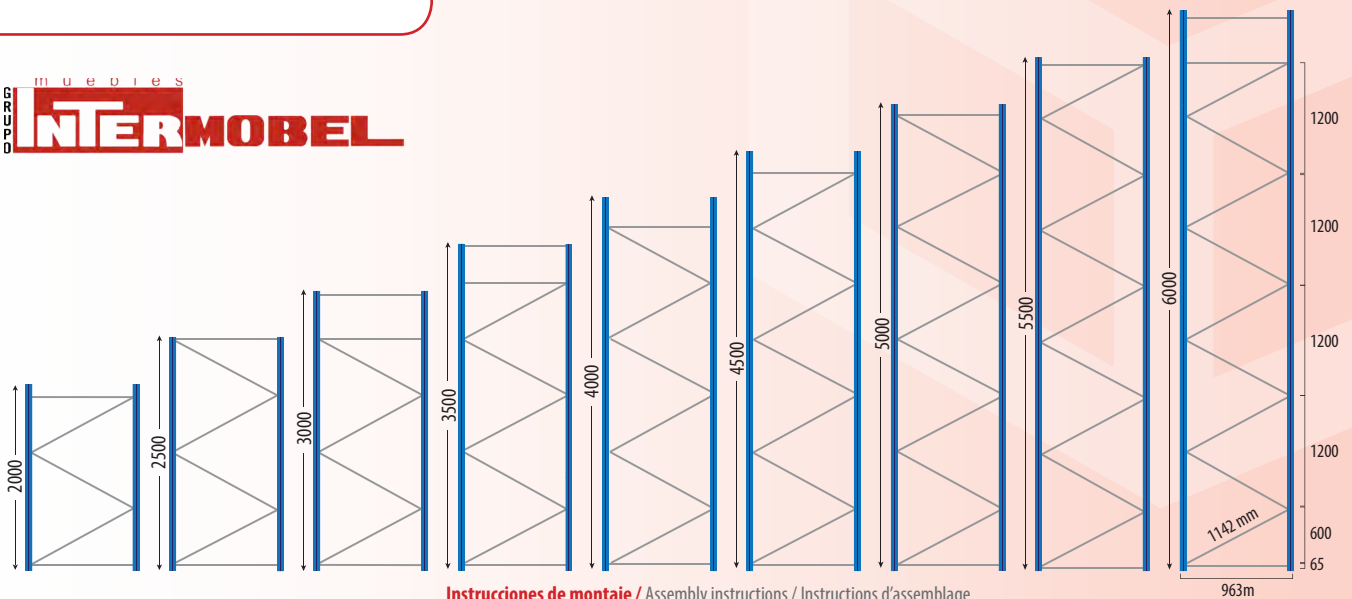

Instrucciones de montaje / Assembly instructions / Instructions d'assemblage

# Paletización convencional / Pallet Racking / Rack à palette



**Perno de seguridad / Safety pin / Goupille de sécurité**

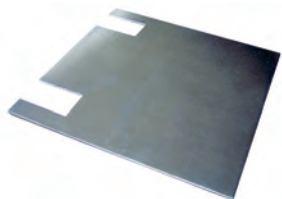

**Pletina de nivelación / Levelling plate / Plaques de calage**



**Anclaje M10 x 70 / Anchor M10 x 70 / Ancrage M10 x 70**



**Anclajes no incluidos**  
Anchors not included  
Ancrages non inclus



**Tornillería incluida**  
Screws included  
Vis incluses



## Accesorios / Accessories / Accessoires

Artículo Item Article	Referencia Reference Référence	Peso kg Weight kg Poids kg	Uds. Paquete Units package Unités paquet
Perno de seguridad / Larguero Safety pin / Beam Goupille de sécurité / Lisse	77000001	0,01	2
Pletina de nivelación 1,5 mm Levelling plate 1,5 mm Plaques de calage 1,5 mm	77000008	0,21	2
Anclaje M10 x 70/14 / Suelo Anchor M10 x 70/14 / Floor Ancrage M10 x 70/14 / Sol	77000032	0,07	4

**Galvanizado / Galvanized / Galvanisée**



## Protecciones y anclaje / Protections ans ancrors / Protections et ancrage

Artículo Item Article	Referencia Reference Référence	Peso kg Weight kg Poids kg	Uds. Paquete Units package Unités paquet
Protección bastidor Upright protection Protection échelle	77000033	8,39	1
Protección lateral 1150 mm Side protection 1150 mm Protection latérale 1150 mm	77000034	6,18	1
Protección lateral 2500 mm Side protection 2500 mm Protection latérale 2500 mm	77000035	19,48	1
Anclaje M16 x 110/20 / Protector Anchor M16 x 110/20 / Protector Ancrage M16 x 110/20 / Protecteur	77000036	0,27	4

**RAL 1003 amarillo / Yellow / Jaune**





Tornillería incluida / Screws included / Vis incluses



2uds.



Tornillería incluida / Screws included / Vis incluses



4uds.

**Uniones /** Attachment / Unions

Artículo Item Article	Referencia Reference Référence	Peso kg Weight kg Poids kg	Uds. Paquete Units package Unités paquet
Unión a pared 100 mm Attachment to wall 100 mm Fixation au mur 100 mm	77000037	0,24	1
Unión a pared 200 mm Attachment to wall 200 mm Fixation au mur 200 mm	77000038	0,38	1
Unión a pared 300 mm Attachment to wall 300 mm Fixation au mur 300 mm	77000039	0,52	1
Unión bifrontal 300 mm Bi-frontal attachment 300 mm Union bifrontale 300 mm	77000048	0,55	1

Galvanizado / Galvanized / Galvanisée

**Travesaños /** Cross members / Traverses

Artículo Item Article	Referencia Reference Référence	Peso kg Weight kg Poids kg	Uds. Paquete Units package Unités paquet
Travesaño exterior aglomerado 1050 mm External chipboard cross member 1050 mm Traverse extérieure bois 1050 mm	77000053	3,21	1
Travesaño interior paleta 1050 mm Internal pallet cross member 1050 mm Traverse intérieure palette 1050 mm	77000056	4,12	1

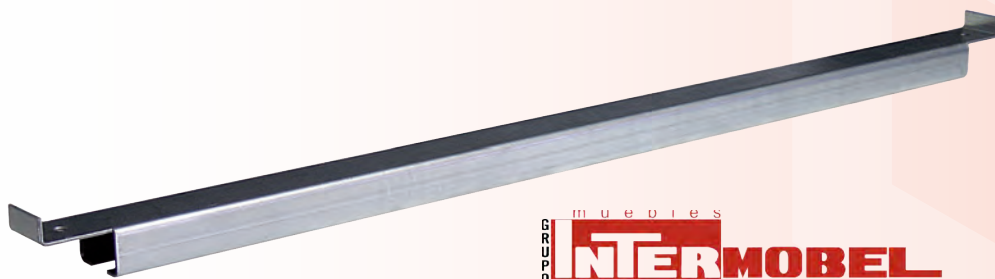

Galvanizado / Galvanized / Galvanisée

Referencia / Reference / Référence: 77000053

GRUP  
O m u e b l e s  
**INTERMOBEL**

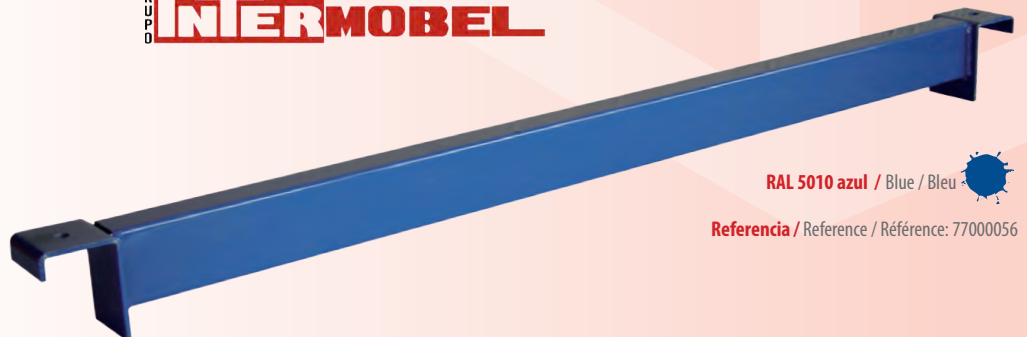

RAL 5010 azul / Blue / Bleu

Referencia / Reference / Référence: 77000056

*e s t a n t e r í a s*  
**JOMASI**  
SOCIEDAD LIMITADA

 Parque Industrial "El Polígono" Avda. Río Ebro, 18  
50410 Cuarte de Huerva (Zaragoza) España  
Teléfono (+34) 976 504 103  
info@estanteriasjomasi.com

*m u e b l e s*  
**GRUPO INTERMOBEL**