



SONRÍE Do it again!

MOBILIARIO JUVENIL



MUEBLES
GRUPO
INTERMOBEL

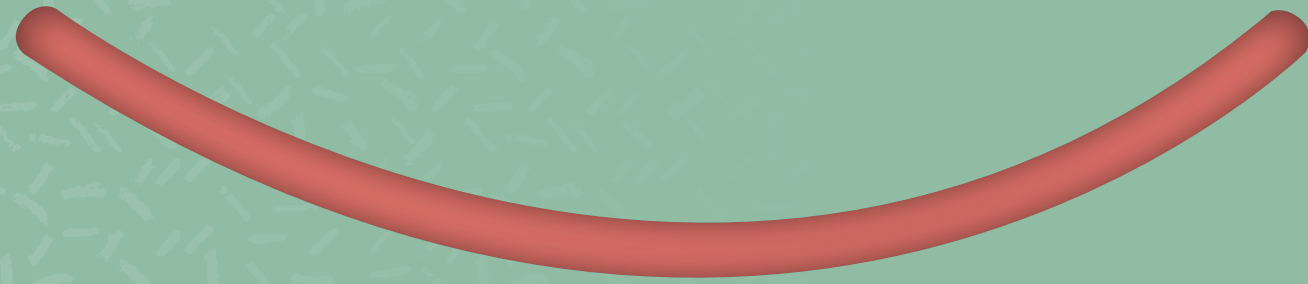

SONRÍE

Do it again!

Muebles Orts

MOBILIARIO JUVENIL.....

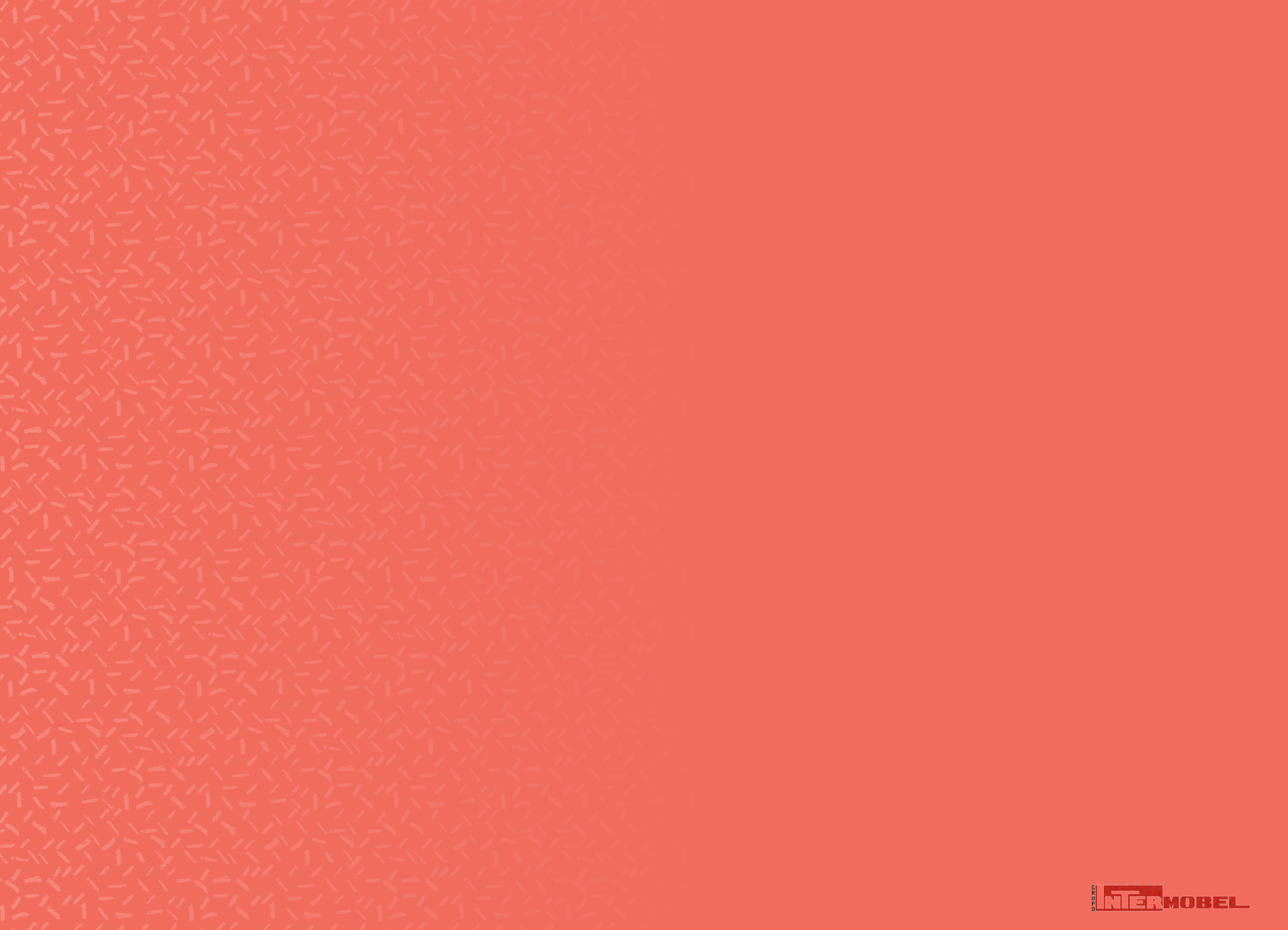

Muebles Orts



GRUPO
MUEBLES
INTERMOBEL

Piensa en algo que te guste mucho, dibuja esa imagen en tu mente y empieza a sentir lo que te provoca. Poco a poco notarás un ligero movimiento en tus labios, deja que la boca se acerque y que se muestren tus dientes. Muéstrale al mundo el poder de la sonrisa dibujada en tu rostro. Las sonrisas provocan emociones positivas en los demás, sonreír te alegrará a ti y también a las personas que te rodean.



SONRÍE

Do it again!



Medidas especiales

Una esquina complicada, un techo demasiado alto o bajo, demasiadas ventanas... Las medidas especiales son la solución a cualquier problema de tamaño para adaptarse a tus necesidades.



Diseño

Diseño y funcionalidad van de la mano. Ofrecemos múltiples soluciones que se adaptan a tus gustos y estilo, siempre en concordancia con las últimas tendencias.

muebles
INTERMOBEL



Forma

Utilizamos herrajes de alta calidad y resistencia para conseguir un producto final con unas prestaciones inigualables.



Colores

Combina colores sin límites. Puedes combinar todos los colores que te ofrecemos en cualquier producto del catálogo.



SONRÍE

CAMAS NIDO, COMPACTOS Y CAMAS MODULARES

Camas nido y compactos PS
Compactos Base 19
Compactos Base 35
Camas modulares

P.07

CAMAS ABATIBLES Y LITERAS

Abatibles
Literas
Literas mini
Cama alta block

P.61

CAMAS

Camas elevables
Camas juveniles
Camas matrimonio

P.111

MOBILIARIO INFANTIL

Cunas convertibles
Cunas
Mesas y taburetes

P.161

ACABADOS Y TIRADORES

P.187

COMPOSICIONES

P.193

CALIDAD Y DIFERENCIACIÓN

En Muebles Orts saltamos obstáculos, es por ello que, te ofrecemos una relación calidad precio inigualable.

Nuestro equipo, altamente cualificado, trabaja para ofrecerte muchas razones por las cuales elegimos.



SILENT SYSTEM.
Guías ocultas con cierre amortiguado. La amortiguación integrada cierra el cajón de una forma suave y silenciosa.



Puerto USB.
Ofrecemos un sistema de conexión USB para embutir.



CABEZALES TAPIZADOS.
Cabezales con acabado textil en diferentes colores.



CARGADOR WIRELESS.
El cargador está totalmente oculto en el mueble sin afectar al propio diseño, un simple adhesivo para indicar el punto de carga es lo único que se mantiene visible.



SEGURIDAD.
Bajada con retención en abatibles mediante pistones hidráulicos y patas abatibles sincronizadas.



SEGURIDAD.
Tapa de metacrilato en cama abatible horizontal para evitar el atrapamiento de los dedos al bajar la cama.

SOLUCIONES PARA ILUMINAR

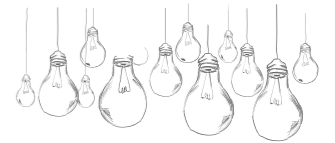

SEGURIDAD.
Tapa cubre pistones en abatibles. Cuidamos los detalles, tanto funcionales como estéticos.



PORO NATURAL.
Acabado con efecto madera.



PERSONALIZACIÓN.
Múltiples complementos para personalizar los muebles.



LÁMPARA DE LECTURA FLEXIBLE.
Lámpara con dos entradas USB integradas y regulador de intensidad.



REGLETA LED.
Se enciende con interruptor.



SISTEMA DE BLOQUEO.
Ofrecemos una mayor seguridad para camas abatibles horizontales.



SISTEMA.
Bloqueo autocierre en abatible horizontal con escritorio para una mayor seguridad.



AMORTIGUACIÓN INTEGRADA.
Bisagra automática con montaje por clip y cierre amortiguado.



REGLETA LED DE SUPERFICIE.
Se enciende por detector de movimiento.



LÁMPARA USB FLEXIBLE.
Fuente de alimentación en USB, interruptor táctil touch con regulador de intensidad.

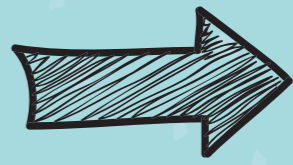

No hay
límites
¡Disfruta!



CAMAS NIDO, COMPACTOS Y
CAMAS MODULARES

muebles
INTERMOBEL

Pequeños espacios llenos de vida para poder disfrutar del placer de ser niños.



NOVEDAD

TACTO MADERA

Personaliza los muebles con los complementos que te ofrecemos para que sean únicos.



01

JUEGO DE VOLÚMENES A DIFERENTES ALTURAS

Presentamos como novedad el armario elevado. Un armario a tu gusto, en el que podrás elegir el ancho, la combinación de colores, las patas del módulo elevado y la terminación del módulo a suelo.



T78- Curry



T75- Curry



Estocolmo



Curry



Azul Pastel

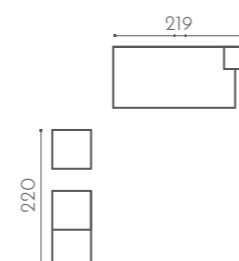







02

TODO LO QUE NECESITAS

Te ofrecemos una solución que permite tener un armario con puertas plegables, una repisa y un arcón en 60x100cm.

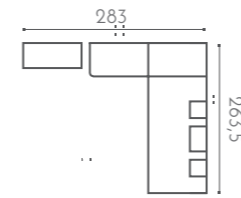
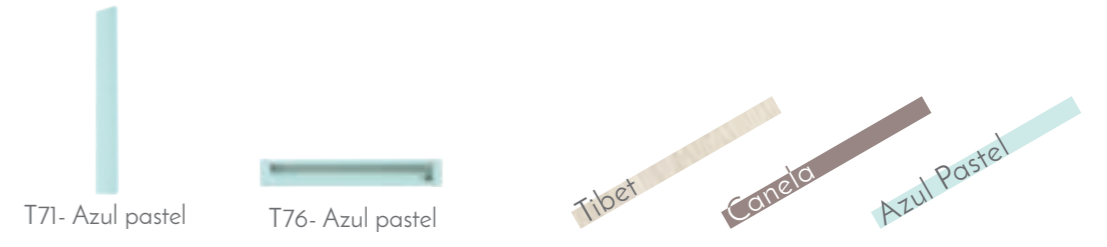

NEW NOVEDAD

TACTO MADERA

muebles
INTERMOBEL

CUIDAMOS LOS DETALLES

El marco metálico del armario cubre la función de elemento estructural al mismo tiempo que presenta un diseño ligero con líneas simples.



En poco espacio....
¡Lo tienes todo!



03

FORMAS SIMPLES

Hemos reducido la distancia entre el extremo de la sobretapa y el compacto para que el ancho útil sea mayor.

ACCESIBILIDAD

Bandejas extraíbles para poder utilizar en su totalidad la profundidad del arcón.

Piezas diferentes para mantenerlo todo en orden. Soluciones que se adaptan a tu día a día.

	NOVEDAD
	TACTO MADERA
	LUZ LED
	IMPRESIÓN DIGITAL

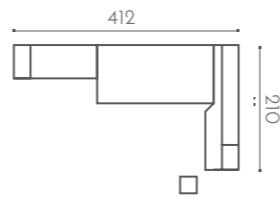

::

..



T79- Azul pastel



T86- Azul pastel



Combinaciones de colores llenas de vida en un espacio que prima la personalidad y el máximo aprovechamiento.



04

Comodidad, seguridad y gran capacidad de almacenaje.

Diseños con magia para los más pequeños. Portalápices incorporado en mesa infantil para que nada les moleste cuando de crear se trata.

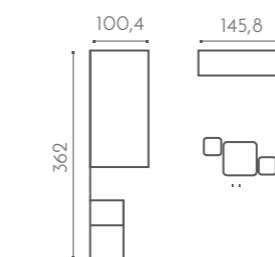

T76- Verde pastel



Tiempo para todo.



Cada cosa requiere su espacio, es por ello que te ofrecemos diferentes terminaciones para el armario elevado, para que elijas tu propio orden.





05

Os presentamos el armario con puertas plegables en el que puedes combinar colores, elegir el color del perfil exterior de las puertas, el tirador y además te ofrecemos la posibilidad de introducir la imagen que desees para que vaya a conjunto con el resto de la habitación. SIENTE, CREA.

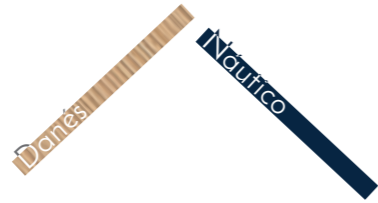

T72



T77- Náutico

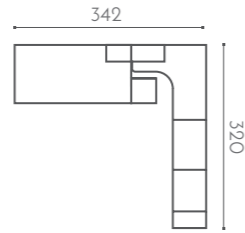

GRUPO MUEBLES **INTERMOBEL**

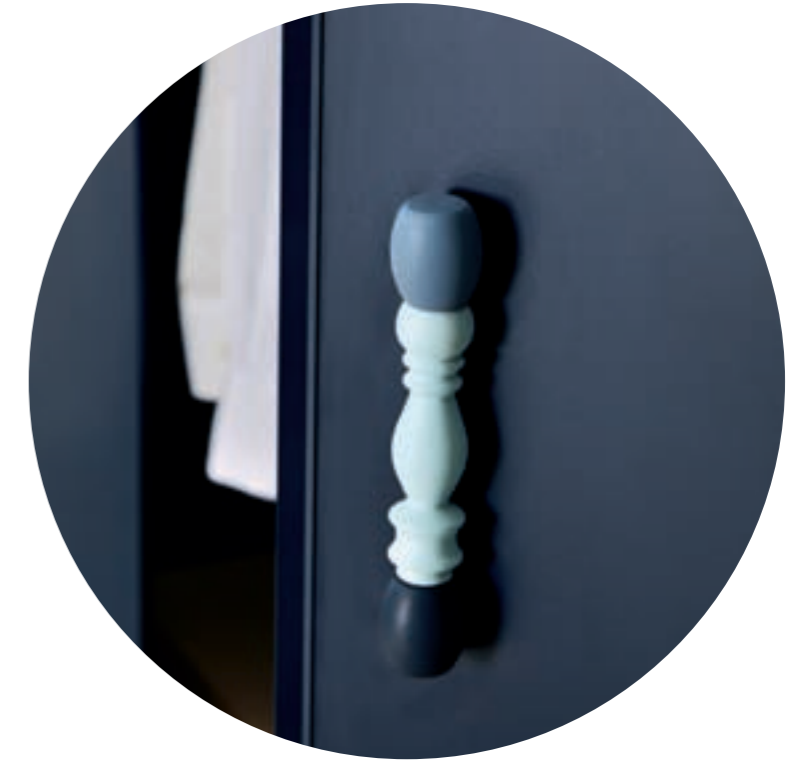

Expresa tus gustos sin límites.

	NOVEDAD
	TACTO MADERA
	IMPRESIÓN DIGITAL





06

GRACIAS A LAS CURVAS, PODEMOS ADAPTARNOS A TODO TIPO DE ESPACIOS

Armario rincón acompañado de terminal estantes para tener una mayor sensación de amplitud a la entrada de la habitación. Máxima versatilidad en los complementos para el interior del armario.

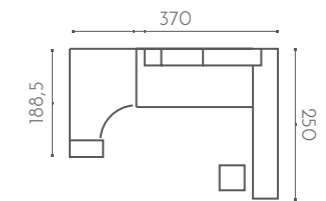
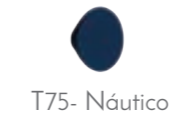

Gran capacidad de almacenaje gracias a la altura del compacto, la cual nos permite tener 3 cajones y 2 baúles.

NEW	NOVEDAD
	TACTO MADERA

Soluciones adaptables a diferentes espacios.









Diseños de tendencia en una propuesta para una habitación larga y estrecha.

GRUPO MUEBLES
INTERMOBEL

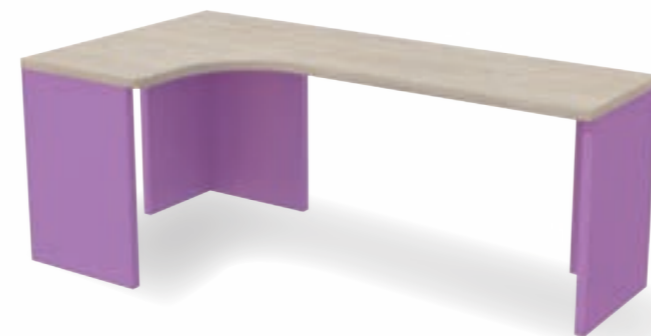
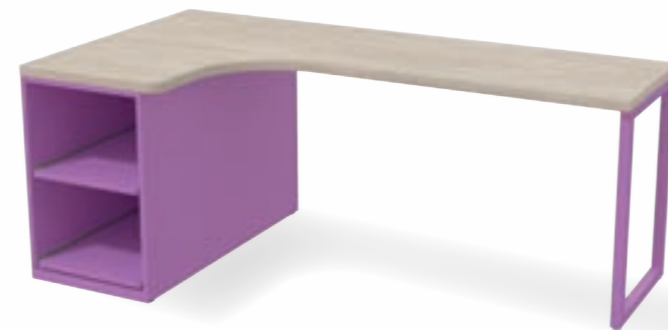

07

Tenemos que sentirnos bien en nuestro día a día, por ello, te invitamos a que personalices tu zona de estudio entre las diferentes posibilidades que te ofrecemos en tarifa. Combina colores, formas y complementos. ATREVETE.



08

La librería diáfana nos permite integrar la zona de descanso y la de estudio en un mismo espacio.

Espacios que se adaptan a tu estilo de vida. Sobretapa con cargador inalámbrico wireless que te permite cargar tu Smartphone sin necesidad de cables, simplemente dejándolo encima de un pequeño adhesivo que nos servirá de referencia.



T79- Turquesa fresh

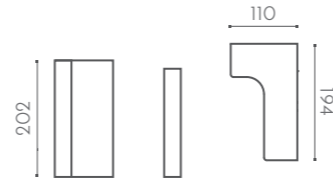

- NEW** NOVEDAD
- TACTO MADERA
- CARGADOR WIRELESS



Integra 2 zonas en un mismo espacio.









Cuando el diseño y la funcionalidad están en equilibrio.

09

Cubos que hablan por sí solos, sirven tanto para decorar como para organizar.

Te ofrecemos muchas opciones de personalización en puertas de armarios, el perfil de las puertas japonesas, combinaciones de colores, tiradores... y además, múltiples accesorios.

¡ DESCÚBRELOS !

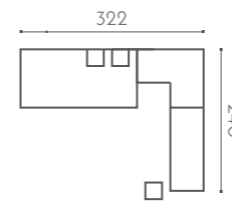
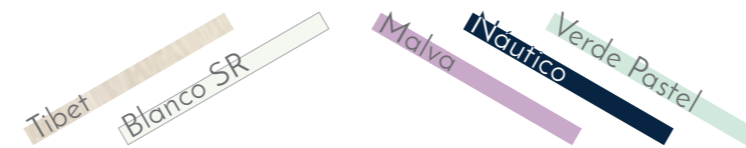



Un espacio sencillo y práctico que se adapta a las necesidades actuales.



10 Llevamos la personalización al límite. Entendemos que cada persona es única, por ello, te ofrecemos una gran variedad de módulos para introducir en el interior del armazón. Podrás elegir el tamaño, el color y los tiradores. También podrás elegir las patas del armazón, siendo estas; patas de metacrilato, patas cónicas o ruedas.

Cargador USB integrado en la sobretapa para que conectar sea muy fácil.



NEW	NOVEDAD
	TACTO MADERA
	USB

Estocolmo
Blanco SR
Antracita
Musgo

T71- Musgo

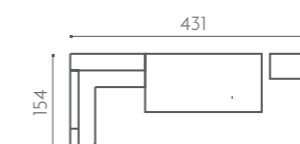

GRUPO MUEBLES **INTERMOBEL**

Combinaciones que no pasan de moda llenas de detalles que marcan la diferencia.



11

Las patas cónicas sobre las que apoya la sobretapa aportan diseño y ligereza.

La librería bifacial a la entrada de la habitación aporta luz y amplitud en un espacio en el que predomina la calma y el orden.

Como novedad, regleta de led. Para esta habitación hemos optado por colocarla encima del compacto, en el ángulo que se crea entre la pared y el armario rincón.

	NOVEDAD
	TACTO MADERA
	LUZ LED



T81- Rojo

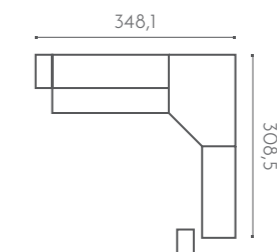

muebles
INTERMOBEL



¡Atrévete a iluminar!
¡Atrévete a crear!



12

Introduce la imagen que desees en cualquier mueble. ¡EXPRESA TUS GUSTOS!

Máxima versatilidad en iluminación gracias a las regletas de LED. Puedes colocarlas donde quieras. Nosotros te ofrecemos múltiples opciones... Te invitamos a que nos sorprenda.

Desplazable oculto con frontal abatible para ofrecerte una mayor comodidad.

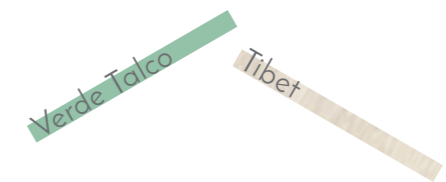

T76- Verde talco



T70- Verde talco

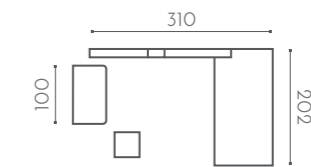

	TACTO MADERA	NEW	NOVEDADES
	LUZ LED		IMPRESIÓN DIGITAL
	APERTURA PUSH		



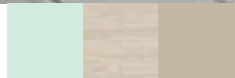

MUEBLES
INTERMOBEL

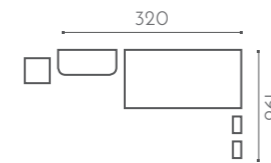

13
 Siéntete libre para subir, bajar, saltar, jugar, bailar, cantar...
 Compactos a tu gusto. Elige entre las diferentes alturas de compacto que te ofrecemos y las múltiples combinaciones.



Perfecto equilibrio
 entre diversión y
 aprendizaje.

	NOVEDAD
	TACTO MADERA
	IMPRESIÓN DIGITAL

14

Configura sin límites el armazón personalizable. Introduce los módulos que encajen con tus necesidades.

Soluciones minimalistas para resolver los pequeños problemas que nos podemos encontrar en el hogar.

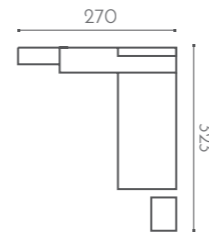
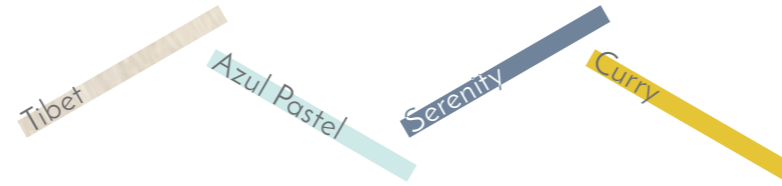

Diseños en tendencia.



Xifoniers con múltiples combinaciones en colores, patas y tiradores. ¿Te atreves a crear el tuyo?

¡Dale color a la vida, SIN MIEDO!





15

El compartir cuarto es una excelente forma de aprender cosas tan importantes como empatizar, resolver conflictos, respetar al otro y formar un lazo especial.

Zona de estudio para 2. Combinación de puente con módulo soporte para aprovechar al máximo el espacio disponible en la zona de estudio.

Como novedad presentamos el soporte para puente. Una solución pensada para que el soporte se integre perfectamente en el puente pareciendo una única pieza. CALIDAD Y SEGURIDAD.

Habitaciones para compartir.

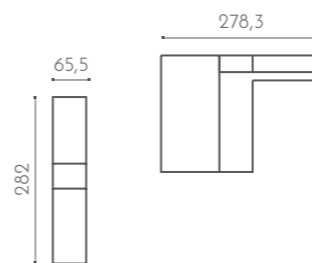





16

Cuando diseñamos, queremos que todo encaje. Con el terminal chaflán conseguiremos un mayor ángulo de visibilidad.

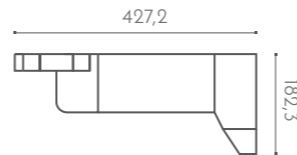

NEW	NOVEDAD
	TACTO MADERA

muebles
INTERMOBEL

El conjunto perfecto.







T73



Espacios sencillos con
soluciones prácticas.

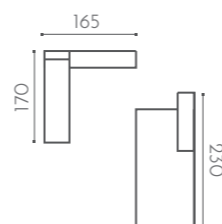

17
Sistemas prácticos para tu día
a día.
Compacto con ruedas para
poder mover la cama y facilitar
el manejo del mismo.





Es solo cuestión de darle la forma deseada...



Juego de espesores estéticamente atractivo. Gracias a los armazones personalizables, podemos configurar su interior con los módulos que queramos. En esta composición hemos combinado cubos diáfanos de 10mm de espesor para crear ese juego de espesores que tanto nos gusta.

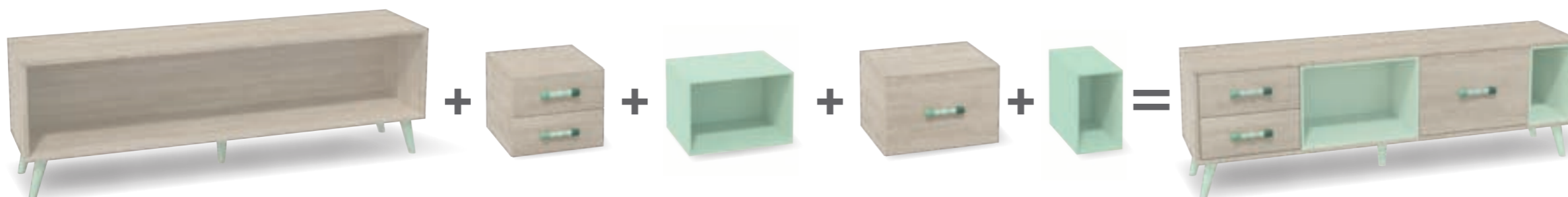



Os presentamos la línea Slim que nos aporta estilo y nos da un toque fino y elegante en un ambiente juvenil.

Aire renovado a los complementos.

Cama y escritorio 2 en 1.



T70- Violeta

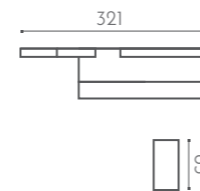

18

Una solución que nos permite tener un escritorio y una cama en tan solo 2x1m en una propuesta estéticamente perfecta.

Cambia las formas. Armazón con patas de metacrilato. Las patas de metacrilato nos aportan ligereza en el ambiente y un toque sofisticado.

Combinaciones equilibradas de módulos a pared que sirven tanto para decorar como para almacenar.



muebles
INTERMOBEL





Dormitorios que nos recuerdan que somos niños.



muebles
INTERMOBEL



19

En muebles Orts, ser niño es fácil. Divertidos estantes con red que nos recuerdan que tenemos que jugar estemos donde estemos.

Puedes personalizar tanto el interior del armazón como las patas. Propuesta de armazón con pata cónica en color coral, un color lleno de alegría y vitalidad.

Para espacios pequeños, las camas con puertas correderas son una solución perfecta.

Nosotros también le damos rienda suelta a la imaginación, es por ello que hemos colocado encima del armazón personalizable una estantería kit. Mira el resultado. ¡Es genial!

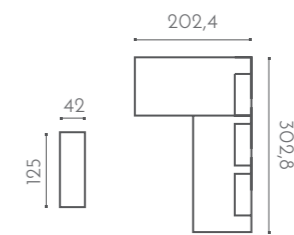



muebles
INTERMOBEL



Soluciones prácticas para tu día a día.

20

Solo cuando lo necesites.

Arcón escritorio en zona de paso, para extraerlo únicamente cuando sea necesario. El interior del arcón, se encuentra dividido en 2 partes, a una de ella accederemos por la parte superior y a la otra por la zona del escritorio.

Estantes simpáticos que dan un guiño a nuestras necesidades diarias.

NEW NOVEDAD

TACTO MADERA

muebles
INTERMOBEL



Como novedad presentamos el armario mesita. Puedes personalizar el color del marco entre las opciones de colores que te ofrecemos para darle un toque personal.



Estocolmo
Fresa



T80- Náutico



T71- Náutico

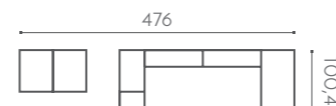

21

Zona de estudio delimitada con pintura en pared.
 Sobretapa angular con cantos redondeados para una mayor seguridad.

Hemos mejorado la calidad. Te ofrecemos cajones con guías ocultas y cierre amortiguado para marcar la diferencia entre lo bueno y lo mejor.



T80- Rosa pastel

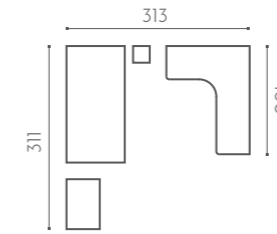

NEW	NOVEDAD
	TACTO MADERA



Juego de volúmenes en un espacio pequeño.







22

Este compacto se caracteriza por tener la misma medida de colchón en las dos camas.

Espacios que conectan contigo.

Lineas rectas, cantos redondeados y soluciones prácticas en la zona escritorio.



NEW	NOVEDAD
	TACTO MADERA
	USB
	APERTURA PUSH

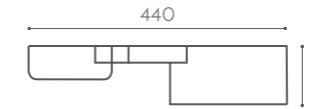

Dos camas de 90x190 en un único compacto



Soluciones versátiles

23

Para nosotros, es muy importante aprovechar al máximo el espacio del que disponemos, siempre siguiendo una estética y un orden. Como novedad, te ofrecemos las camas modulares que te permitirán colocar los módulos a tu gusto.

Conjunto de cama modular con armarios, acompañado de puente con estructura resistente. Dicha estructura se esconde en la parte inferior para obtener una vista general más limpia.

Con el Tirador T83 (uso exclusivo para armarios) te ofrecemos la posibilidad de combinar con otro color la puerta del armario.

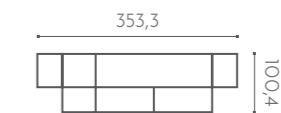
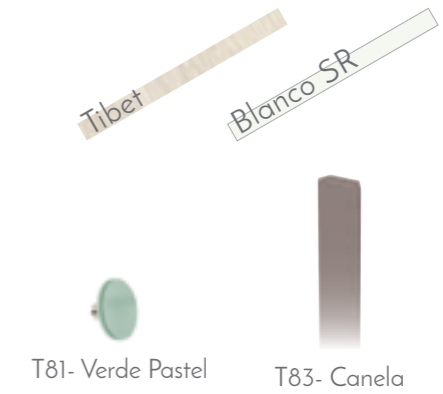

NEW NOVEDAD

TACTO MADERA



24

Práctico vestidor con original combinación. Combinamos cajones y barras de colgar, acompañados con cubos en la parte central para compartir. Nuestros vestidores se adaptan a tu espacio para sacarle partido a cada centímetro.

Las camas modulares son tan versátiles que nos permiten crear ambientes que combinan con el espíritu práctico y el diseño.

NEW NOVEDAD

TACTO MADERA



T76- Antracita



T76- Arena

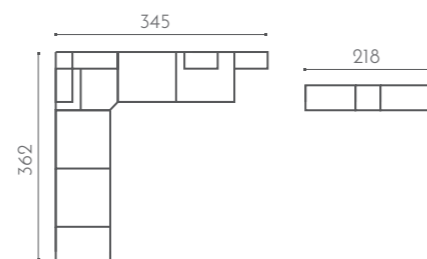

Zona vestidor y zona descanso perfectamente integradas.



Originalidad y minimalismo en un espacio lleno de vitalidad.

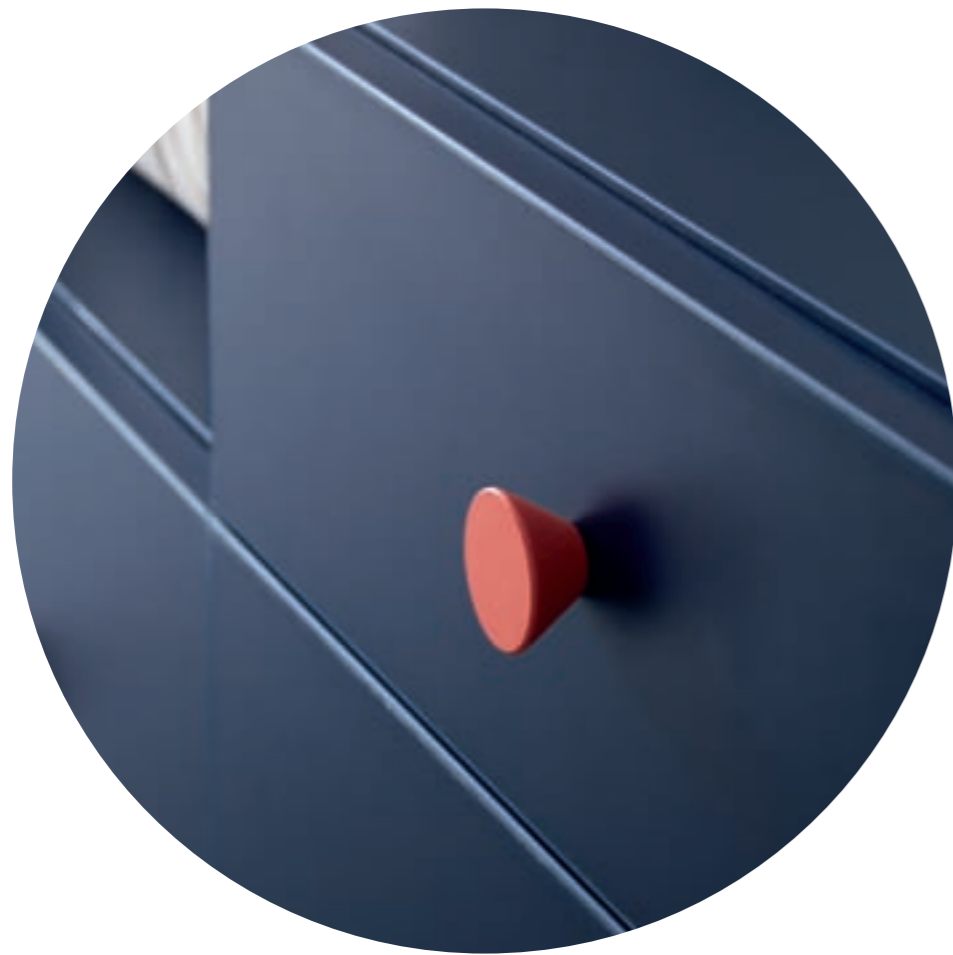

25

Múltiples opciones en un mismo espacio.
Cama modular que integra zona escritorio con armario.
Armario elevado con un diseño singular que resalta por las cintas que tiene en el lateral para poder dejar objetos accediendo desde la cama.
Con la pata de metacrilato conseguimos que parezca que está en el aire.

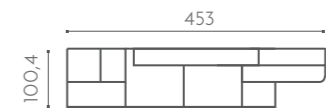
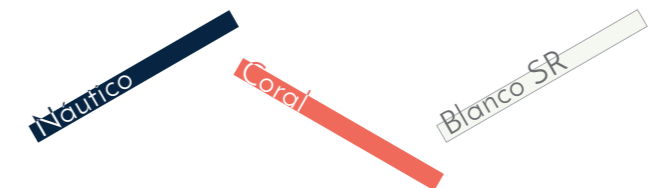

muebles
INTERMOBEL







! YES!

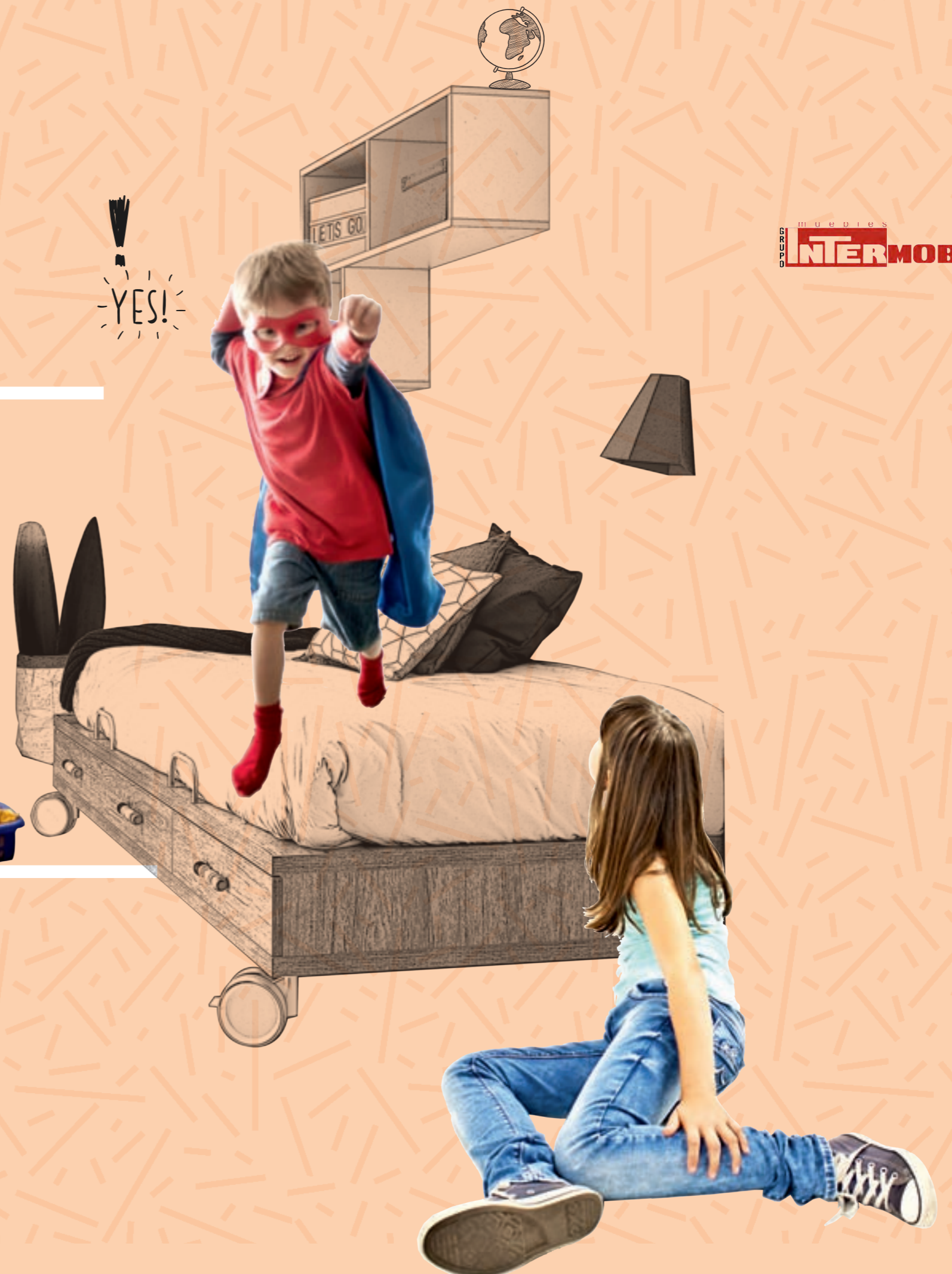

La ilusión de un nuevo dormitorio

CAMAS ABATIBLES Y LITERAS



muebles
INTERMOBEL

Muebles Orts



Per- so- na- li- za.

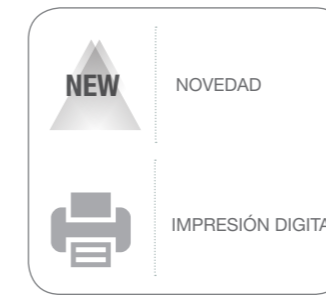

NOVEDAD

IMPRESIÓN DIGITAL

26

Gracias a la impresión digital puedes personalizar nuestros muebles a tu gusto. Envíanos tu propia imagen o selecciona una de entre la variedad de imágenes predeterminadas que ponemos a tu disposición.

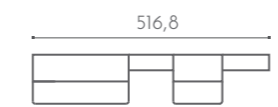

Antracita
Zanahoria
Azul Pastel

muebles
INTERMOBEL

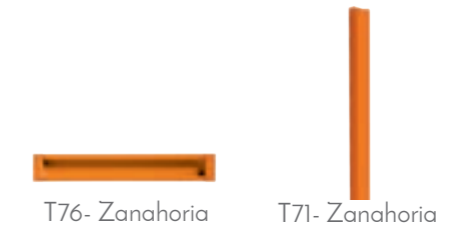

SEGURIDAD en cama abatible horizontal que evita el atrapamiento de los dedos al bajar la cama.



SEGURIDAD. Tapa cubre pistones en abatibles. Cuidamos los detalles, tanto funcionales como estéticos.



SISTEMA DE BLOQUEO en abatibles horizontales para una mayor seguridad.





27

Cama abatible con mesa auxiliar para disfrutar del espacio en su totalidad durante el día. Por la noche, con un simple movimiento tienes la cama lista.

Bajada en retención para evitar golpes.

Ofrecemos como novedad la tapa cubre pistones en las camas abatibles verticales.

Versatilidad interior y exterior en los módulos personalizables. Muévelo dependiendo del momento del día.

Simpáticas mesas auxiliares que se entrelazan por la diferencia de altura y tamaño entre ellas.

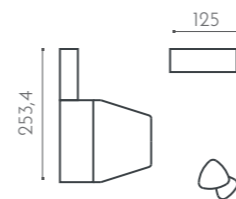

Espacios para disfrutar tanto del día como de la noche.

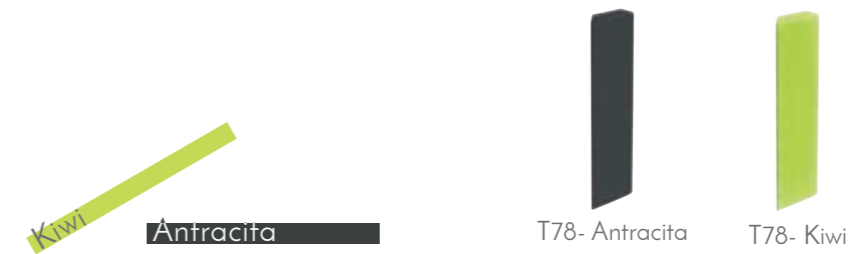





28

Conjunto de armarios con puertas bicolor horizontal para que combines a tu gusto.

Con el armario mesita conseguimos una mayor visibilidad del espacio a la entrada de la habitación.

Espacio de día y noche en un abrir y cerrar de ojos. Cama vertical con escritorio y patas abatibles sincronizadas.

Módulo auxiliar con pata cónica que le aporta al ambiente calidez y aire fresco.



Espacios con mucha personalidad.

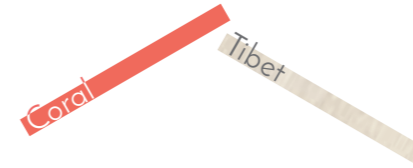

T76- Gris Metal

T76- Coral

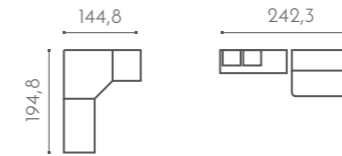

GRUPO MUEBLES
INTERMOBEL





29

¡Personaliza sin límites!
Infografías, colores, perfiles...

Habitaciones con múltiples
soluciones adaptadas a ti. Te
ofrecemos una amplia gama de
productos para que puedas
elegir.

T72

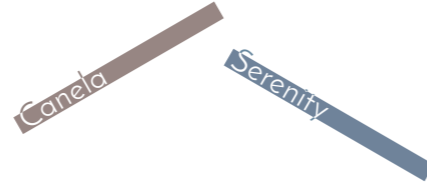

Soluciones prácticas para cuando disponemos de poco espacio.



GRUPO
muebles
INTERMOBEL

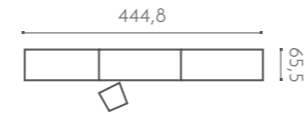



Espacios para relajarse y para estudiar.
En Muebles Orts, todo es posible...

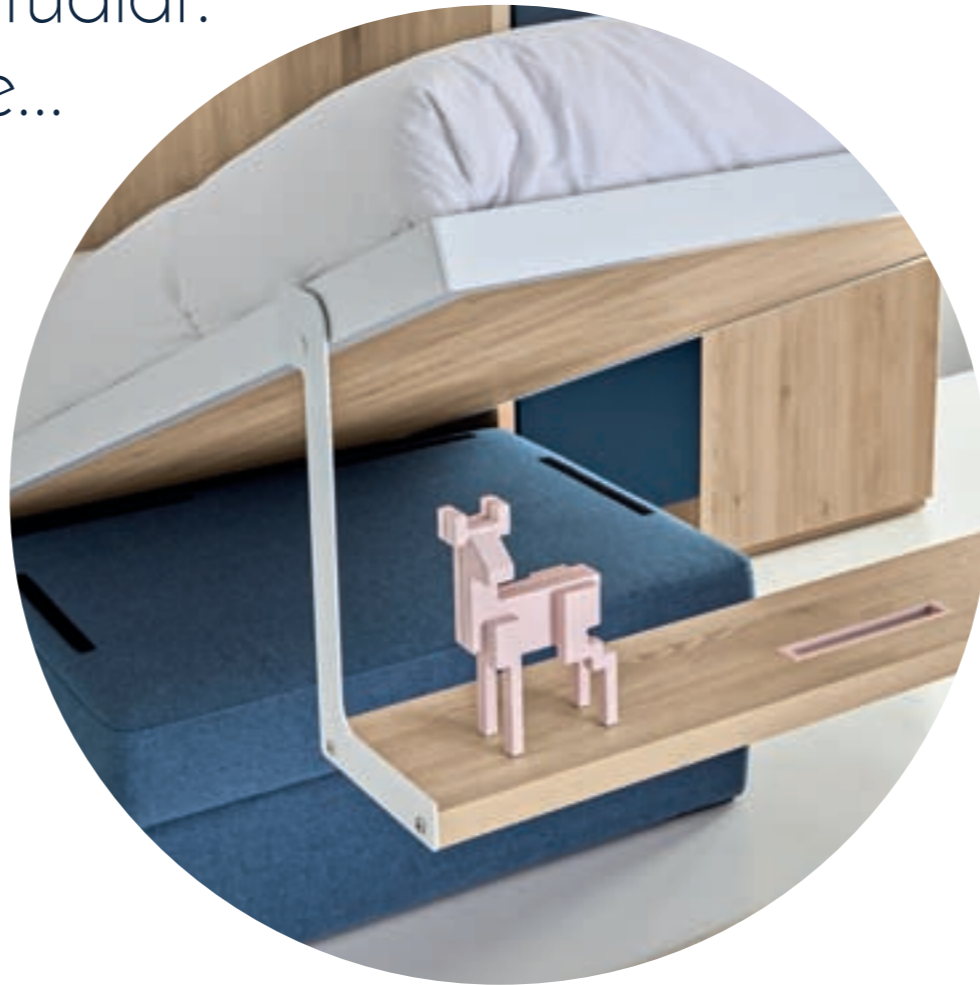

30

El armario elevado al estar colocado al lado de la cama abatible, crea un juego de alturas muy atractivo.

Seguridad en cama abatible horizontal, que evita que en la bajada de la cama se nos queden los dedos atrapados. Sistema de bloqueo autocierre para una mayor seguridad.

La cama abatible con sofá es una perfecta opción para disponer de una cama de invitados.

Danés

Náutico

Rosa Pastel

T126



T76- Rosa Pastel



T80- Rosa Pastel

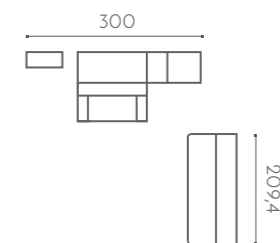

NEW NOVEDAD

TACTO MADERA



31

Doble cama abatible horizontal. En el interior de la litera hemos incorporado como complemento una regleta LED que se enciende con un simple ¡click!

Nos preocupamos de tu seguridad.

El quitamiedos plegable nos permite cerrar la litera sin necesidad de quitarlo, simplemente doblándolo.

Cierre de seguridad para bajar la litera.



T70- Verde Talco

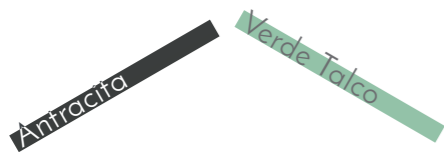

muebles
INTERMOBEL

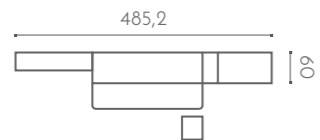

Espacios originales y prácticos. ¡Luz por todas partes! Los momentos más oscuros se convertirán en los más divertidos.



32

Espacios versátiles con máxima capacidad de almacenaje.



muebles
INTERMOBEL

NEW	NOVEDAD
	TACTO MADERA
	IMPRESIÓN DIGITAL

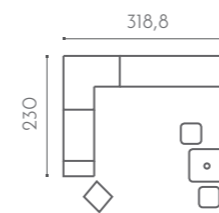



¡¡Atención atención!! NOVEDAD

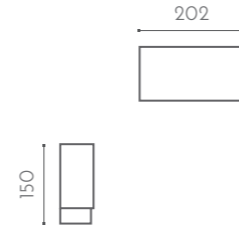

33

La red invita al juego, a la diversión, transmitiendo diferenciación y funcionalidad en nuestros espacios.

Colocando la red en el marco de la litera evitaremos que caiga el cojín.



T76- Zanahoria







Tiempo para todo.

TIME
TO BE.

34

GRUPO MUEBLES
INTERMOBEL



Gris metal
Rosa Pastel

T77- Rosa Pastel

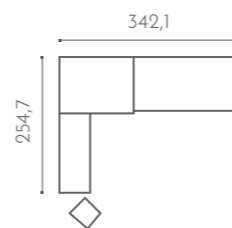

	NOVEDAD
	LUZ LED
	USB





Diversión multiplicada por 2.

muebles
INTERMOBEL

35

Literas con muchas alternativas para que puedas organizar tu dormitorio como mejor se adapte a ti.

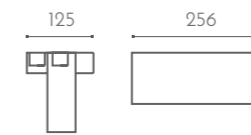
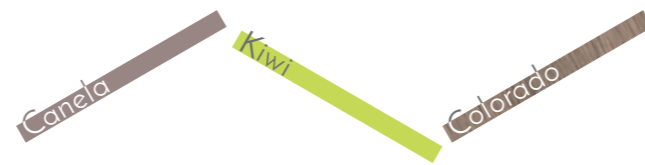



36

No tendrás excusas para invitar a tus amigos. Litera con 3 camas y gran capacidad de almacenaje.

El frontal de la litera con bandeja de metacrilato nos aporta protección y una mayor visibilidad desde la cama superior.

La pata folio tiene un estilo minimalista, encaja en cualquier ambiente y nos aporta estilo.



OSCAR MUEBLES
INTERMOBEL



¿Y si en el espacio que te ocupa una cama tienes tres?

NEW NOVEDAD

TACTO MADERA

T63- Gris Metal

Tibet Serenity

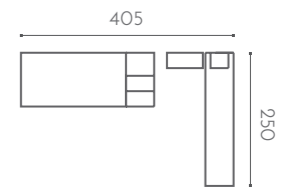

muebles **INTERMOBEL**



37

Diseños delicados y cuidados al detalle para que tu habitación perdure en el tiempo.

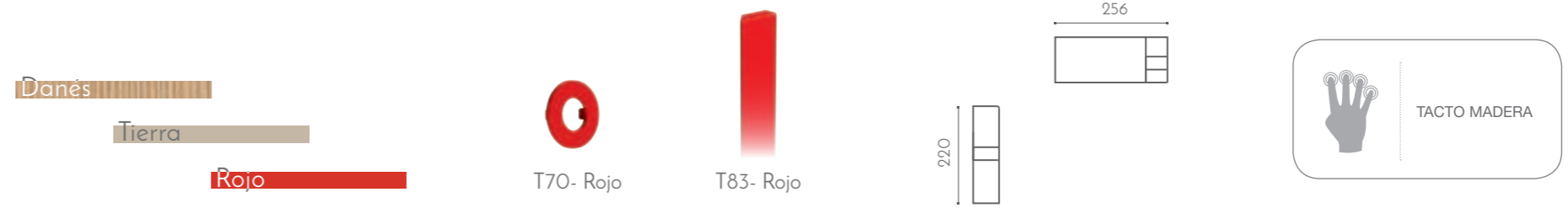



Espacios atemporales.

Dos camas que ocupan el mismo lugar de suelo que una dejando espacio en el resto de la habitación para tus sueños.

38

Tibet

Vino

T75- Vino



muebles
INTERMOBEL





39

Con la litera angular con acceso trasero, conseguimos gran capacidad de almacenaje, al mismo tiempo que al tener libre la parte inferior, podemos utilizarla y darle a la habitación la vida que se merece.

Como novedad, podemos integrar iluminación en la zona del escritorio. La lámpara con soporte para sobretapa tiene regulador de intensidad. ¡Elige la intensidad que necesitas!

Armarios que se adaptan a ti, gracias a las diferentes opciones que te ofrecemos.

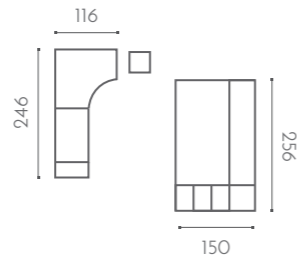

-  NOVEDAD
-  TACTO MADERA
-  LUZ LED



INTERMOBEL

Sácale el máximo partido al espacio.



40

Litera con acceso trasero y hueco libre en la parte inferior pensada para habitaciones singulares. Es imprescindible tener un espacio que nos identifique en el que nos sintamos libres para poder desarrollar toda nuestra creatividad.

Formas que se reducen a su mínima expresión para crear espacios diáfanos. Elemento bandeja metálica incorporado en el frontal de la litera.

Como novedad, mesita con 2 cajones y hueco superior para tener una mayor accesibilidad por la parte superior.

Danés

Rojo

Blanco SR

T79- Blanco SR

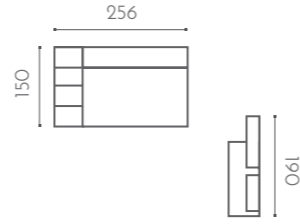

Literas que se convierten en espacios únicos.

MUEBLES
INTERMOBEL





41

Las camas modulares nos ofrecen múltiples soluciones. ¡Colocalas como quieras! En esta habitación hemos combinado una litera con un conjunto de camas modulares y un armario elevado para cama modular.

Cada módulo puede ser usado de forma independiente o en grupo, creando infinitas formas y combinaciones.



T81- Rosa Pastel



T81- Gris Metal

Estocolmo

Rosa Pastel

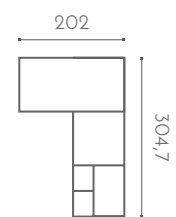

	NOVEDAD
	TACTO MADERA
	LUZ LED

Nuevas perspectivas sobre el espacio.







42
 Los módulos soporte son el complemento ideal para organizar la zona de estudio.

Un espacio en el que la diversión se multiplica por 2.
 ¡Compartir siempre es mejor!

muebles
INTERMOBEL

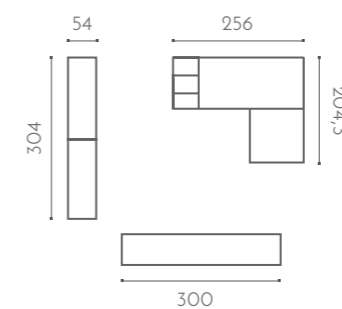

Estocolmo

Rojo



T71- Rojo



T83- Rojo



T75- Rojo

	NOVEDAD
	TACTO MADERA
	LUZ LED

No le pongas límites a la hora de crear la habitación de sus sueños.



¡ Diviértete !



43

Litera mini que te enamorará por sus líneas simples y cuidadas.

La seguridad es importante, es por ello que cuidamos cada detalle pensando en los más pequeños. La escalera para la litera tiene antideslizante en los peldaños. Por otro lado la mesa y los taburetes infantiles, no presentan aristas rectas, evitando así los golpes.

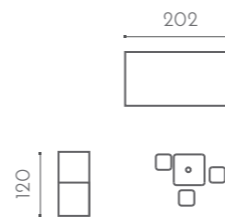
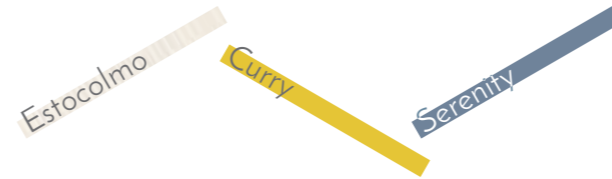

NEW	NOVEDAD
	TACTO MADERA

44
Espacios singulares para que desde bien pequeños crean. Mesa y taburetes con patas cónicas para crear un ambiente cálido.

Literas con una altura adecuada para niños.

Conjunto de mesa y taburetes en forma de trébol. Queda genial en un dormitorio o un cuarto de juegos infantil. Al tener formas redondeadas, evitamos el peligro.

Os presentamos una pieza diferente, única. Se trata de una librería asimétrica con patas cónicas en la que se aprecia un juego de equilibrio.

Castello
Náutico
Azul Pastel

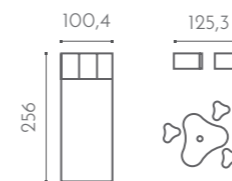

Habitaciones ideales para soñar.

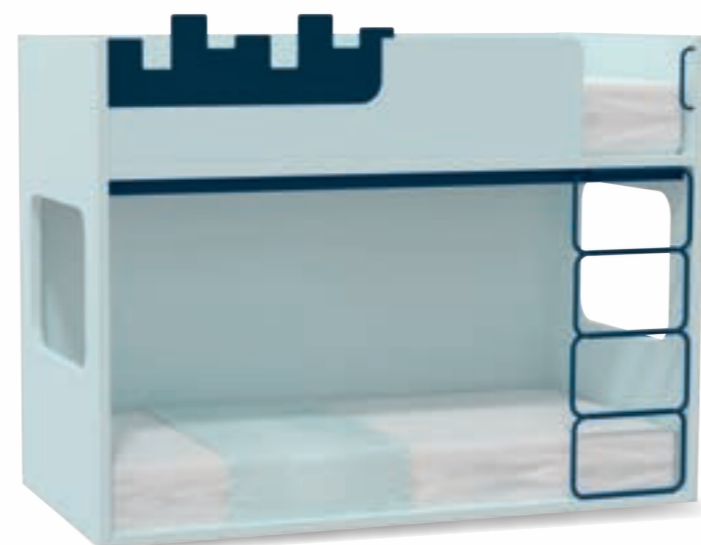







¿Entre las nubes o dentro de un castillo?

45
Programa de armazones personalizables pensados para un almacenamiento singular. Puede servirnos como xifonier, cómoda o mueble auxiliar.

Con la litera mini puedes elegir entre acceso frontal o lateral, frontal con nube o castillo y entre una infinidad de combinaciones de colores.

Rosa Pastel

Canela

Danés

muebles
INTERMOBEL



T76- Canela

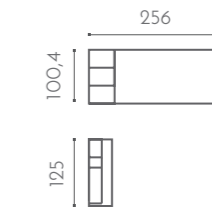

NOVEDAD



TACTO MADERA

46

Litera infantil que te ofrece geniales soluciones de almacenaje y diversión. Con el tobogán conseguirás que el mejor momento del día sea levantarse.

Verde Pastel

Verde Talco

Coral



T83- Coral



T83- Verde Talco

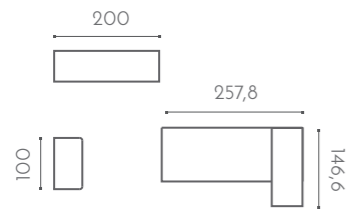

	NOVEDAD
	LUZ LED
	USB

¿Quién dijo que levantarse de la cama no es divertido?





47

A primera vista, una simple litera, pero guarda en su interior sorpresas.
Armario con ruedas, barra extraíble, cajoneras y estantes.



T80- Fresa

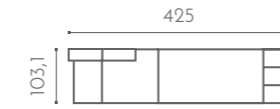

No todo es lo que parece.
¡¡TAXAAAN!!

muebles
INTERMOBEL



48

Novedades en soluciones de almacenaje. Te ofrecemos el puente para cama alta block, para que aproveches al máximo el espacio sea muy sencillo.

Diferenciación es sinónimo de personalidad. Elige entre todas las soluciones que te ofrecemos para crear espacios únicos.

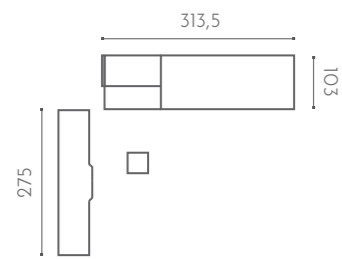
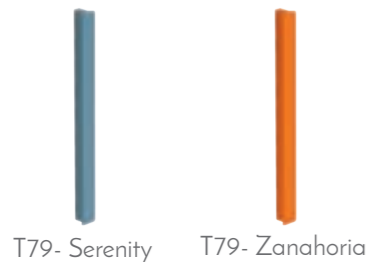
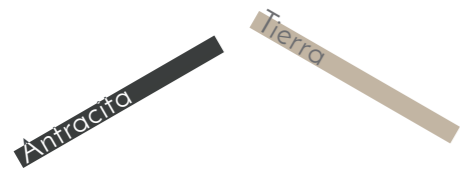

Aprovecha el espacio al máximo.







49

Diseño y funcionalidad a partes iguales. Múltiples módulos con diferentes anchos para que elijas dependiendo de lo que estés buscando. Elegir es tener voz, Elegir es tener criterio. ¡ELIGE!

No te ponemos límites, entendemos que cada persona es diferente, con gustos y percepciones distintas. Elige el terminal que mejor se adapte a tu ritmo de vida.

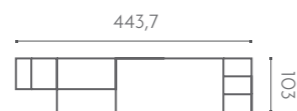
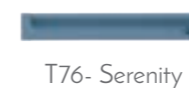

¿Abierto o cerrado?
Simplemente en un abrir y cerrar de ojos.





Hay muchas
formas
de ver tu
dormitorio

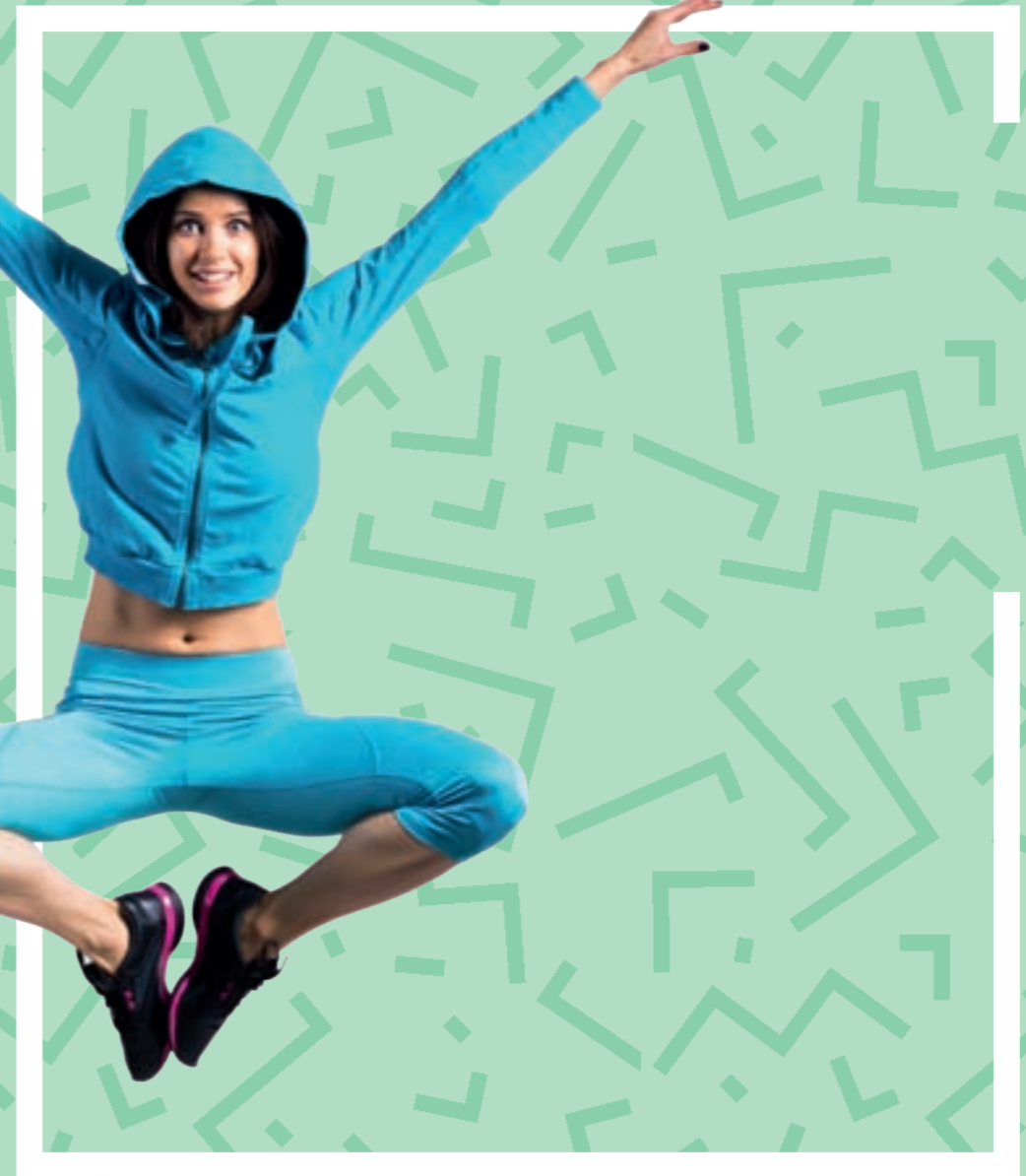

50

Espacio en el que predominan las líneas rectas, el orden y la elegancia. Hemos introducido el color antracita para que rompa la calma en el ambiente y cree un espacio selecto.

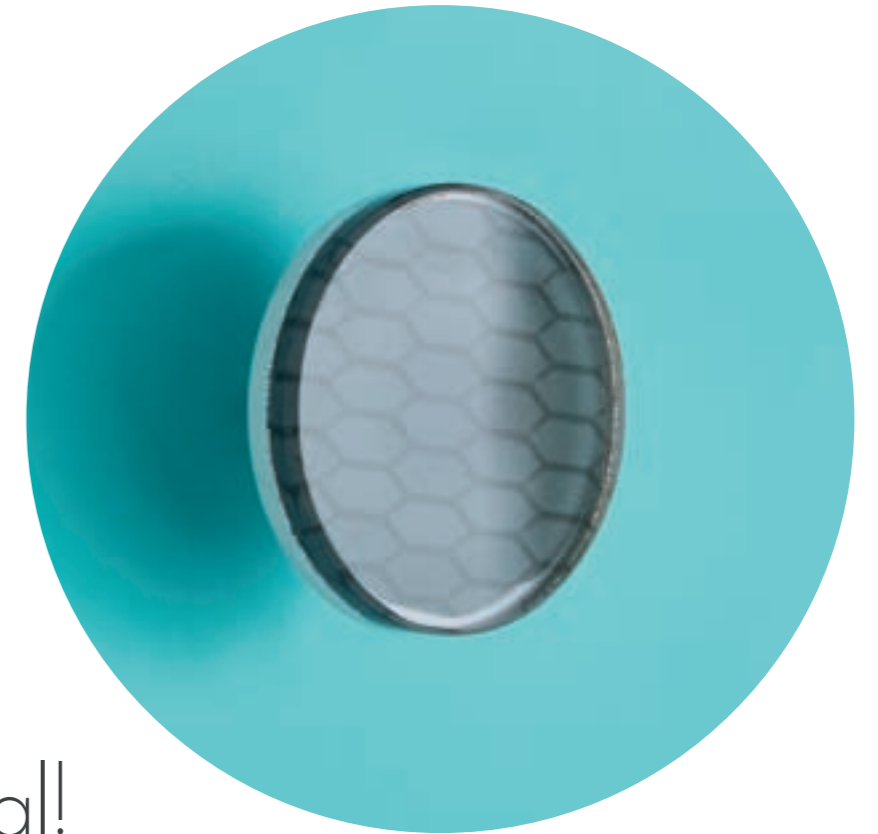
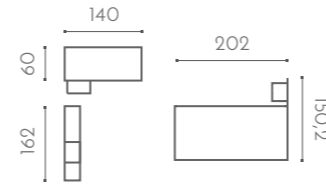

¡Qué original!

muebles
INTERMOBEL







¿Quieres dormir en las nubes?



muebles
INTERMOBEL



51

Sencilla habitación infantil compuesta por un módulo personalizable, mesita, baúl y cabezal con forma de nube. Los cantos redondeados de la cama aportan seguridad para los más pequeños.

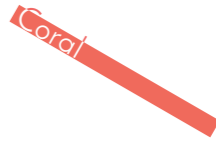

T70- Kiwi

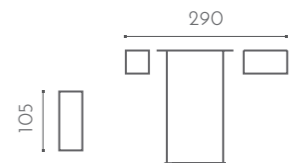



NEW

NOVEDAD



TACTO MADERA

59

Te ofrecemos una gran variedad de camas para que elegir sea fácil. Como novedad, hemos incorporado originales extensiones cabezal para que puedas personalificar las camas.

Estocolmo 

Kiwi 

Musgo 

T109 



T83- Musgo



T83- Kiwi



T77- Kiwi

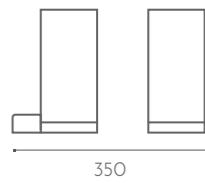
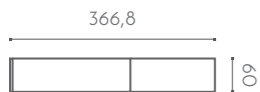

-  NOVEDAD
-  TACTO MADERA
-  LUZ LED
-  USB



¡Comparte, juega, diviértete!







53

Las camas elevables son perfectas cuando no disponemos de mucho espacio. Nos permiten organizar tanto ropa de cama como ropa de temporada.

En esta propuesta, hemos colocado friso para proteger las paredes. Para que puedas ver las múltiples aplicaciones de iluminación que te ofrecemos, hemos optado por poner la regleta de led con interruptor encima en el friso.



T80- Zanahoria

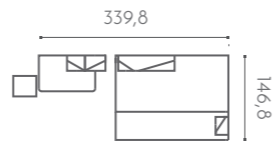

	NOVEDAD
	TACTO MADERA
	LUZ LED

Todo lo que necesitas en 3,4 x 1,5m.



54

Cama elevable horizontal con doble almacenaje sin quitarle espacio a la habitación. ¿No crees que es genial?

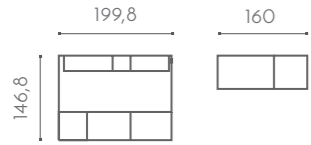

T75- Fresa

NEW NOVEDAD

TACTO MADERA



¿Os gustan los cajones secretos?

muebles **INTERMOBEL**









55

Como novedad, podrás elegir la opción de cama con contenedores en la parte inferior. Tenemos diferentes opciones. Cama preparada para contenedores a la derecha, a la izquierda o ambos lados. Una solución muy práctica para organizar el día a día.

Castello

Azul Pastel

Náutico

Zanahoria



T76- Zanahoria

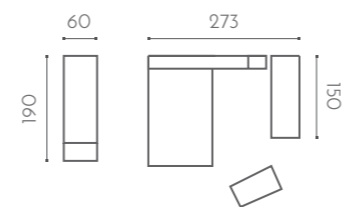

NEW NOVEDAD

TACTO MADERA



GRUPO MUEBLES **INTERMOBEL**

Un extra de espacio.

56

Habitación infantil en la que predominan las líneas rectas y el almacenaje. Juego de armarios colocados uno al lado del otro para crear un efecto espejo.

Malva

Blanco SR

T125

T77- Blanco SR



¿Os gustan las líneas rectas?

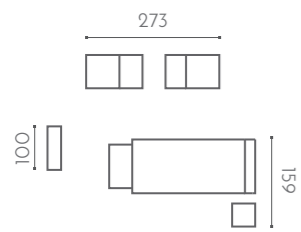



57

Tenemos la solución a tus problemas de espacio. Cama elevable vertical con gran capacidad de almacenaje en su interior, con cubos en piecera, que nos servirán tanto de almacenaje como asiento para calzarnos.

SIÉNTATE, GUARDA, DECORA.

Danés

Curry

Musgo

T63- Musgo

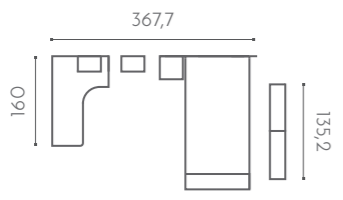

NEW NOVEDAD

TACTO MADERA



OR-GA-NI-ZA-CIÓN.

muebles
INTERMOBEL





58

Entendemos que no todos tenemos los mismos gustos, por ello, te ofrecemos el cabezal personalizable. Partiremos siempre de una pieza triangular y tú elegirás la forma final, dependiendo de cuantos triángulos más añadas.

Colorado ■ ■ Vino ■ Tierra ■



T75- Vino



T81- Tierra

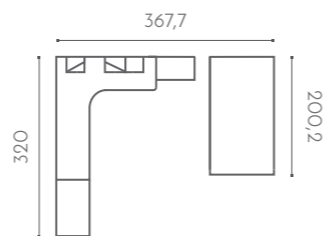

NEW NOVEDAD

TACTO MADERA



Crea sin límites.

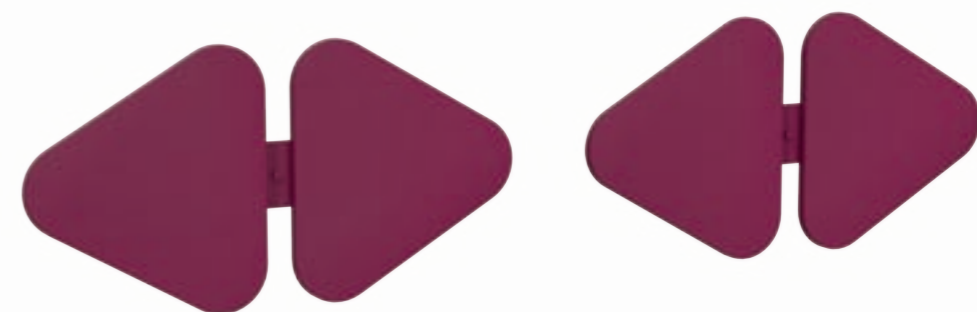



50

Como solución a dicha necesidad, hemos diseñado el armario arcón y el armario para arcón.

El armario arcón presenta un panel fijo en la parte inferior y puertas plegables, mientras que el armario para arcón puedes combinarlo con el arcón que más se ajuste a tus necesidades.

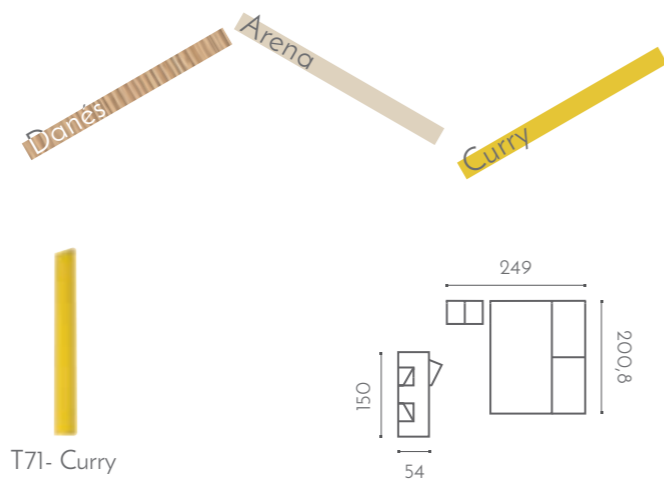

NEW NOVEDAD

TACTO MADERA

Aprovecha el espacio al máximo.

muebles
INTERMOBEL

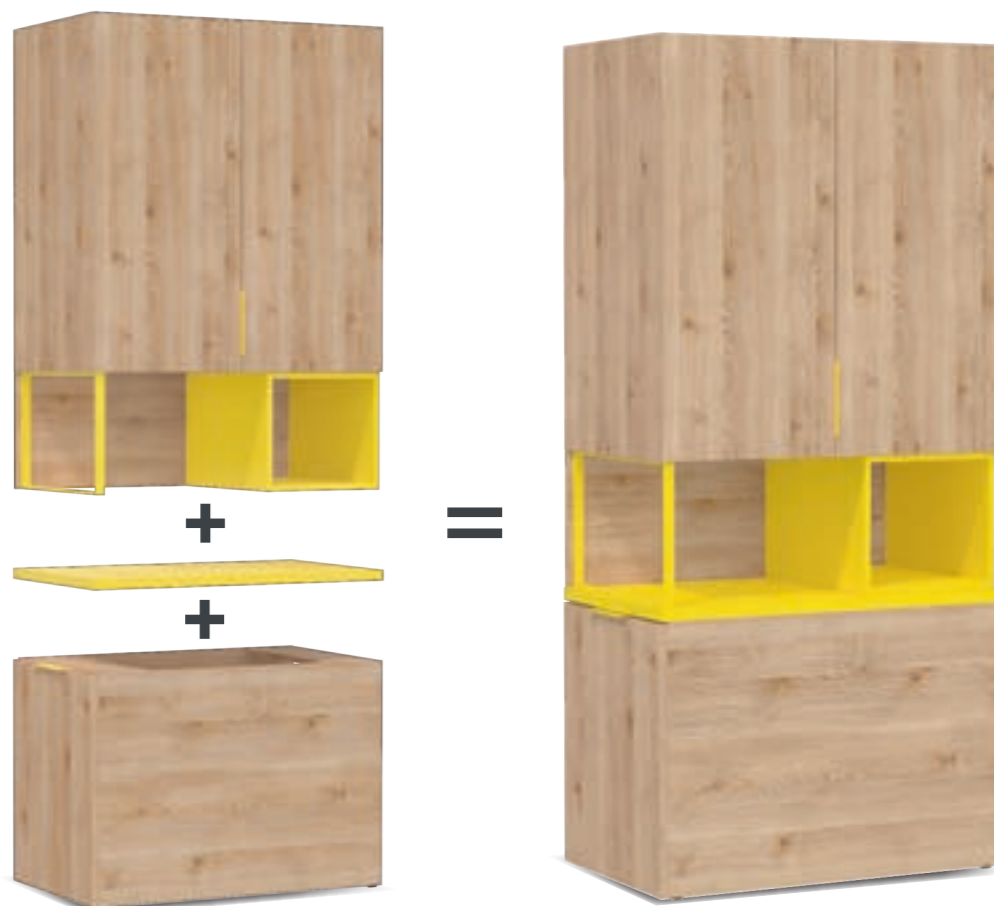





VERSATILITÀ





60

Los puentes son muy versátiles, son perfectos para organizar el espacio acorde con tu día a día. La zona de descanso presenta equilibrio y funcionalidad gracias a la disposición de cada pieza. El armario mesita con 2 cajones cubre la función de mesita de noche y de armario.

- Danés
- Kiwi
- Canela
- Náutico
- Arena
- T126



T78- Kiwi

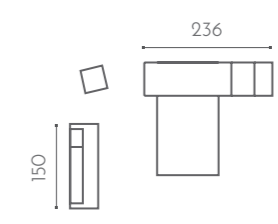

- TACTO MADERA
- NOVEDAD
- APERTURA PUSH





61

Múltiples complementos para personalizar los muebles.

Interruptor táctil touch con regulador de intensidad en cabezales.

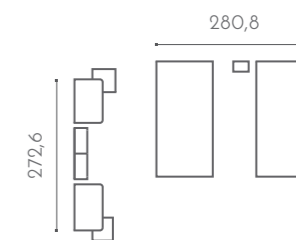

	TACTO MADERA
	LUZ LED
	NOVEDAD
	IMPRESIÓN DIGITAL



T70- Serenity

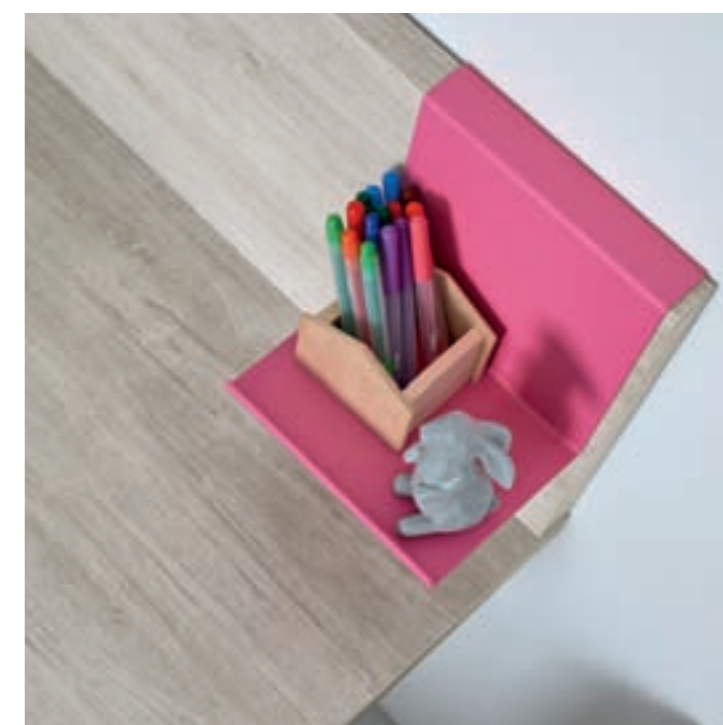

¡A la última!

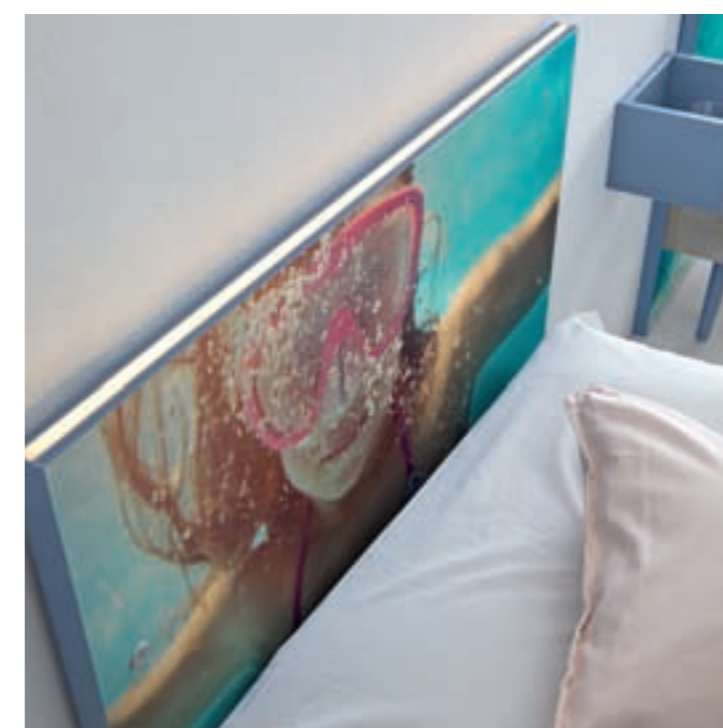
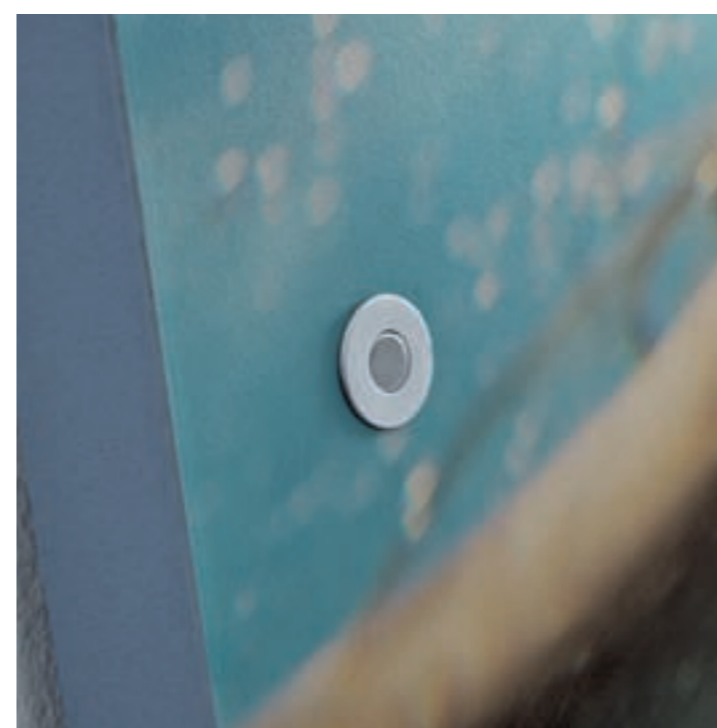





62

Solución de escritorio que descansa sobre mesita 2 cajones con patas cónicas. El marco metálico cumple la función de unión entre ambos elementos.

- Verde Talco
- Gris metal
- Zanahoria
- Danés

T107

T71- Verde Talco

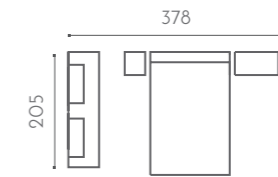

MUEBLES
INTERMOBEL

NEW NOVEDAD

TACTO MADERA

CARGADOR WIRELESS



Ser joven es genial.



63

Dormitorio de matrimonio compuesto por una bañera elevable vertical con cabezal con led al cual le hemos añadido una extensión con 3 puntos de luz. Ambos con interruptor táctil touch con regulador de intensidad.

Original vestidor que podemos ir configurando nosotros mismos, añadiendo los diferentes complementos que te ofrecemos.

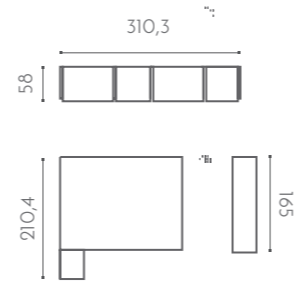

	NOVEDAD
	TACTO MADERA
	LUZ LED

Ilumínate.

muebles
INTERMOBEL





64

Espacio pensado para los "teenagers" de la casa. Formas desenfadadas, con gran variedad de bañeras para que combines a tu gusto. En esta propuesta hemos optado por una bañera con patas cónicas.



NEW NOVEDAD

LED LUZ LED

TACTO MADERA

muebles
INTERMOBEL

Originalidad.





65

Cabeceros tapizados únicos en tu dormitorio. Elige el color de tela que desees entre la amplia gama de colores que te ofrecemos.

Nuevo sistema de abanico mejorado para módulo zapatero.

muebles
INTERMOBEL

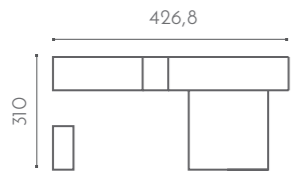

Cabezales Tapizados.









66

El vestidor abierto nos proporciona una mayor sensación de amplitud. Podemos configurarlo como queramos; estantes, lejas, cajones... NO HAY LÍMITES, CREA.

- Colorado
- Coral
- Arena
- Canela
- Tierra



T78- Coral

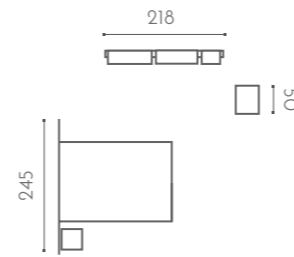

	NOVEDAD
	TACTO MADERA
	LUZ LED
	IMPRESIÓN DIGITAL

Sensación de amplitud.



Un extra de orden.





67

Práctico vestidor compuesto por cajones, barra de colgar y estantes, para que orden y diseño vayan de la mano.

Cabezal con forma singular e iluminación por todo el perímetro. Interruptor táctil touch con regulador de intensidad.

Verde Pastel

Estocolmo

Antracita

Danés

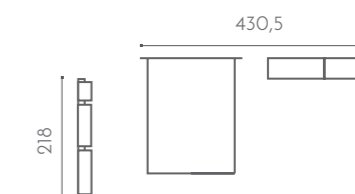

muebles
INTERMOBEL



NOVEDAD



TACTO MADERA



LUZ LED





	NOVEDAD
	TACTO MADERA
	LUZ LED

67

Atmósfera relajante con la Iluminación led.

Encontramos una atmósfera relajante, todo un bálsamo para olvidar los problemas de la vida cotidiana, del trabajo y de la sociedad, y servirá para recargar las pilas y poder afrontar una nueva jornada con ánimos renovados y nuevas perspectivas.







68

El vidrio de color, el metacrilato y las luces, se unen en una propuesta atrevida para ofrecer un resultado muy original.

Las patas de metacrilato aportan ligereza en el ambiente.

Serenity T103

Náutico

Colorado

Tierra Vidrio

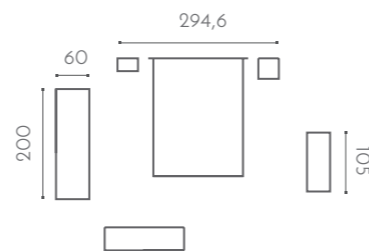
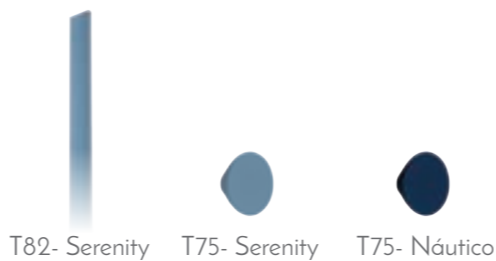

	NOVEDAD
	TACTO MADERA
	LUZ LED



Juego de materiales y luces.



GRUPO **INTERMOBEL**

69

Con los diferentes complementos para armario, conseguimos distinción y personalidad en un ambiente pensado para adultos. Propuesta de armarios con vidrio de color, espejos y complementos. Una propuesta que no pasa desapercibida.

Estocolmo

Blanco SR

Vidrio

Antracita

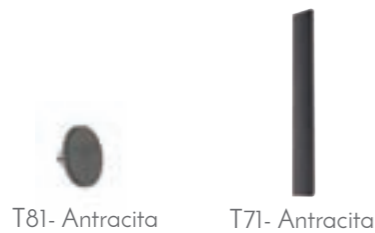
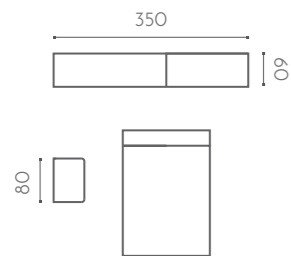

INTERMOBEL

Dos ambientes en un mismo espacio.









70

Cabezal que incorpora 2 lámparas de lectura flexible con regulador de intensidad y puerto USB integrado.

Elige la configuración del cabezal como prefieras; cubo diáfano a la izquierda y bandeja a la derecha...

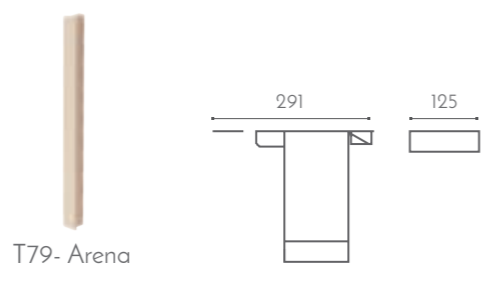
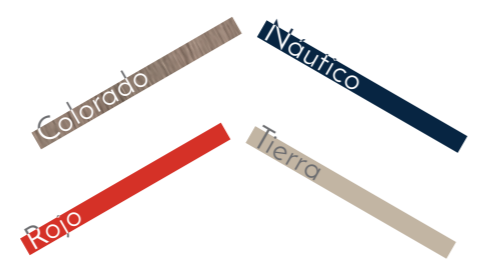

	NOVEDAD
	TACTO MADERA
	LUZ LED



Menos es más.



71

Gracias a la variedad de módulos plataforma que ofrecemos, podéis crear espacios singulares que se adapten a las dimensiones de la habitación para crear una propuesta funcional y atractiva.

Antracita

Danés

T109

Verde Talco



T79- Verde Talco

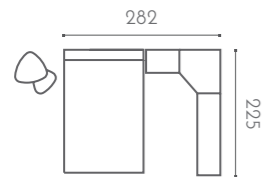

Tenemos la solución a tus problemas de espacio.



NEW NOVEDAD

TACTO MADERA





72

Las camas tatami tienen líneas sencillas que transmiten calma y facilitan el descanso, aspectos especialmente recomendables para un dormitorio. Las camas tatami son tan bajas que transmiten la sensación de estar durmiendo directamente sobre el suelo y su estética es de inspiración japonesa.

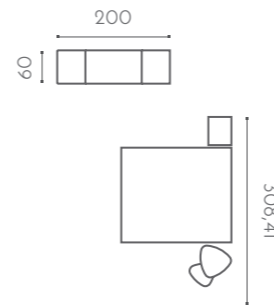
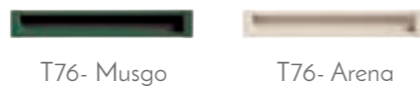

NEW NOVEDAD

TACTO MADERA

¿Una cama japonesa?



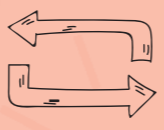
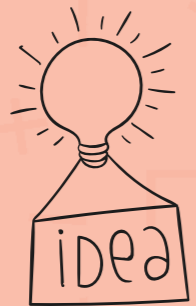

GRUP
MUEBLES
INTERMOBEL





CUNAS CONVERTIBLES
CUNAS
MESAS Y TABURETES

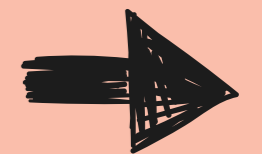

Un nuevo
espacio

GRUPO muebles
INTERMOBEL

Muebles Orts

73

En Muebles Orts sabemos que tu bebé crecerá rapidísimo por ello te ofrecemos cunas convertibles para crecer a su ritmo.

Estocolmo
Fresa
Serenity
Azul Pastel



T72



T70- Fresa



T70- Náutico



T75- Fresa

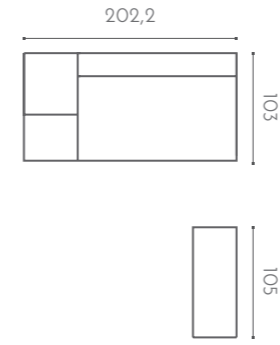

Creceamos a tu ritmo.



MUEBLES
GRUP
INTERMOBEL





INTERMOBEL





Dale sentido al dormitorio mientras crece. **73**

muebles
INTERMOBEL



74

Mobiliario multifuncional.
Por un lado cuna, por otro,
CAMA, ESCRITORIO Y MESITA.

muebles
INTERMOBEL



NEW NOVEDAD

 TACTO MADERA



Multifuncionalidad

Tibet 

Verde Talco 

Nautico 



T78- Nautico T77- Nautico

muoversi
INTERMOBEL

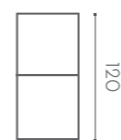
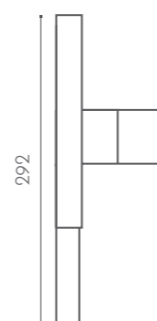

75

Con la cuna convertible modular cuando tu bebé crezca, podrás combinar los módulos como quieras.



muebles
INTERMOBEL



Combina como quieras.

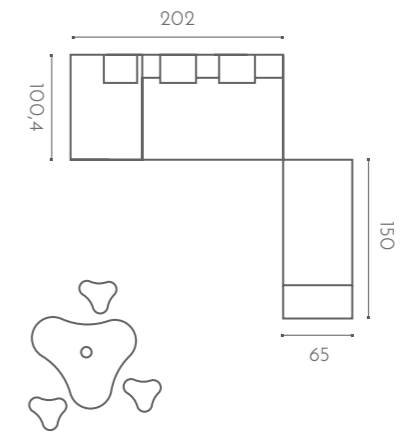

MAGIC
IS SOMETHING
YOU MAKE



muebles
INTERMOBEL

Propuesta
de 2-4 años.

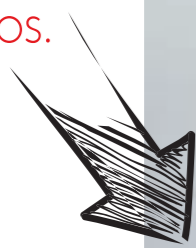

muebles
INTERMOBEL



NEW NOVEDAD

 TACTO MADERA



75

Propuesta de 5-7 años.

Propuesta + de 7 años.



Propuesta de 3-5 años.

Muévelo a tu antojo y dale la forma que quieras.





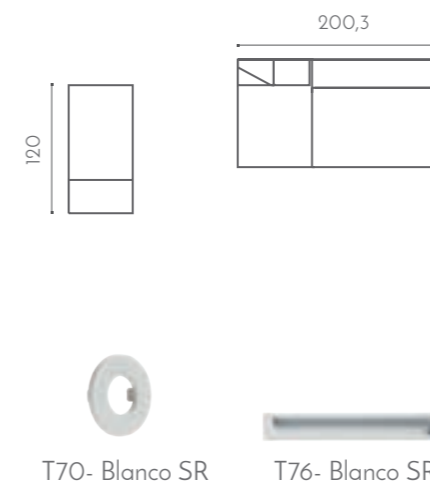
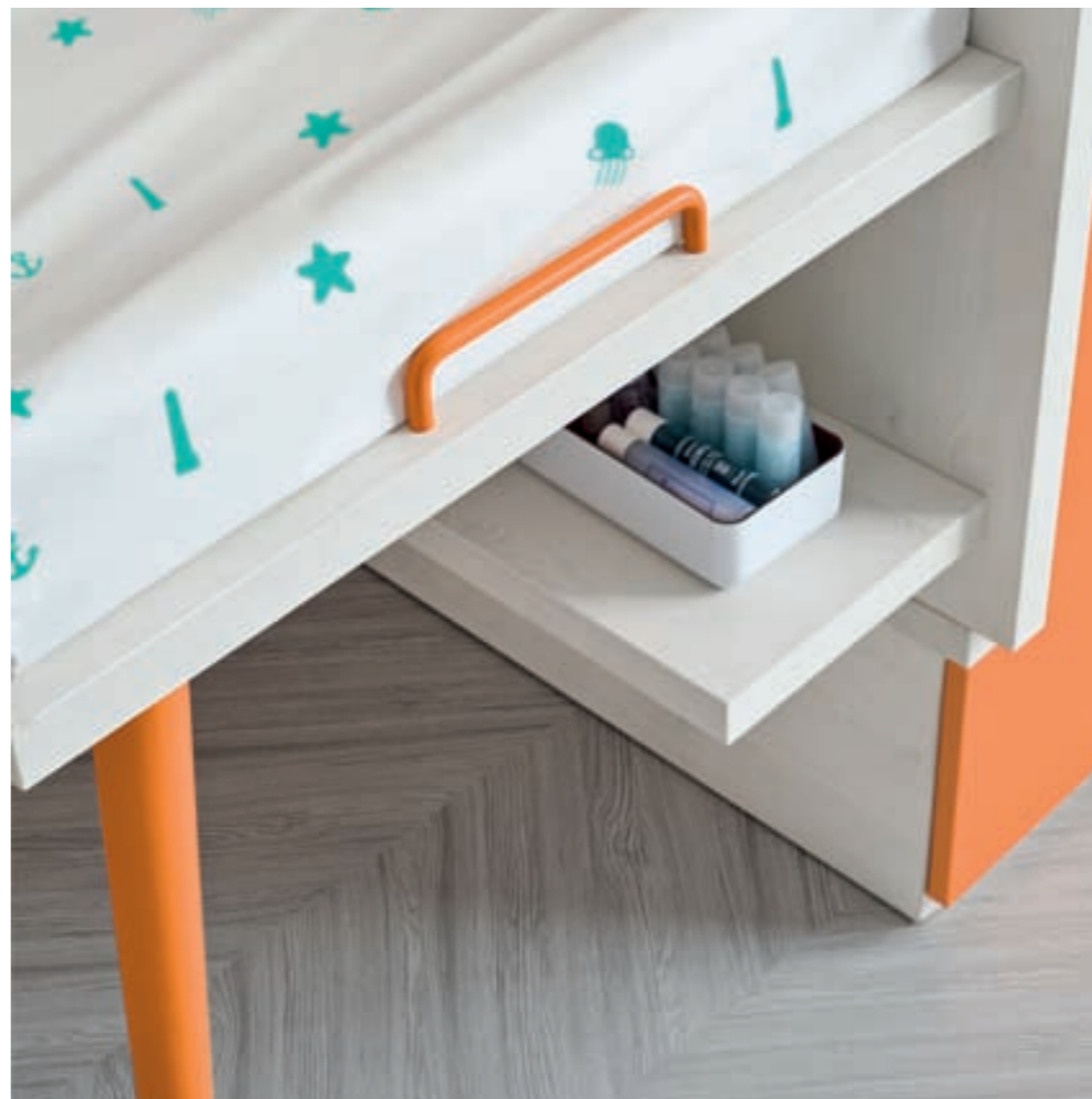

76

Como novedad presentamos la cuna convertible chula. Un convertible que no pasa desapercibido. Dicho convertible se transforma en una cama con contenedores en su parte inferior y un escritorio.

Verde Pastel

Zanahoria

Estocolmo

¡¡Qué chula!!

NEW	NOVEDAD
	TACTO MADERA





muebles
INTERMOBEL



76

	NOVEDAD
	TACTO MADERA

Un dormitorio que crece contigo.





77

Cuna y módulo personalizable con patas de metacrilato para que parezca que el mobiliario está flotando. Espacios llenos de vida.



NEW NOVEDAD

TACTO MADERA

- Castello
- Verde Pastel
- Azul Pastel
- Rosa Pastel



T80- Blanco SR

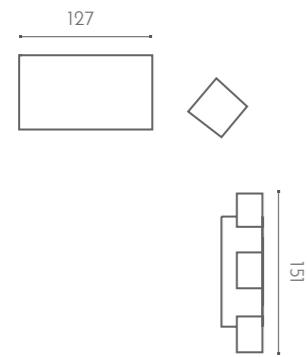

Cuna para que tu bebé se sienta en las nubes.



muebles
INTERMOBEL

78

Como novedad presentamos la cuna con malla transpirable. Tiene fácil limpieza, la cuna está ventilada en todo momento y proporciona tranquilidad para los padres, ya que podrán ver en todo momento el interior de la cuna gracias al tejido de malla.

Malva

Rosa Pastel

Violeta



T74

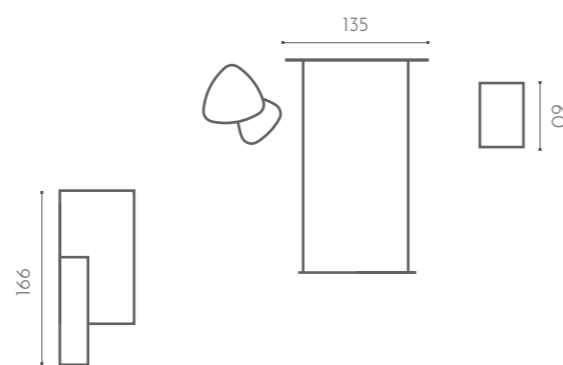
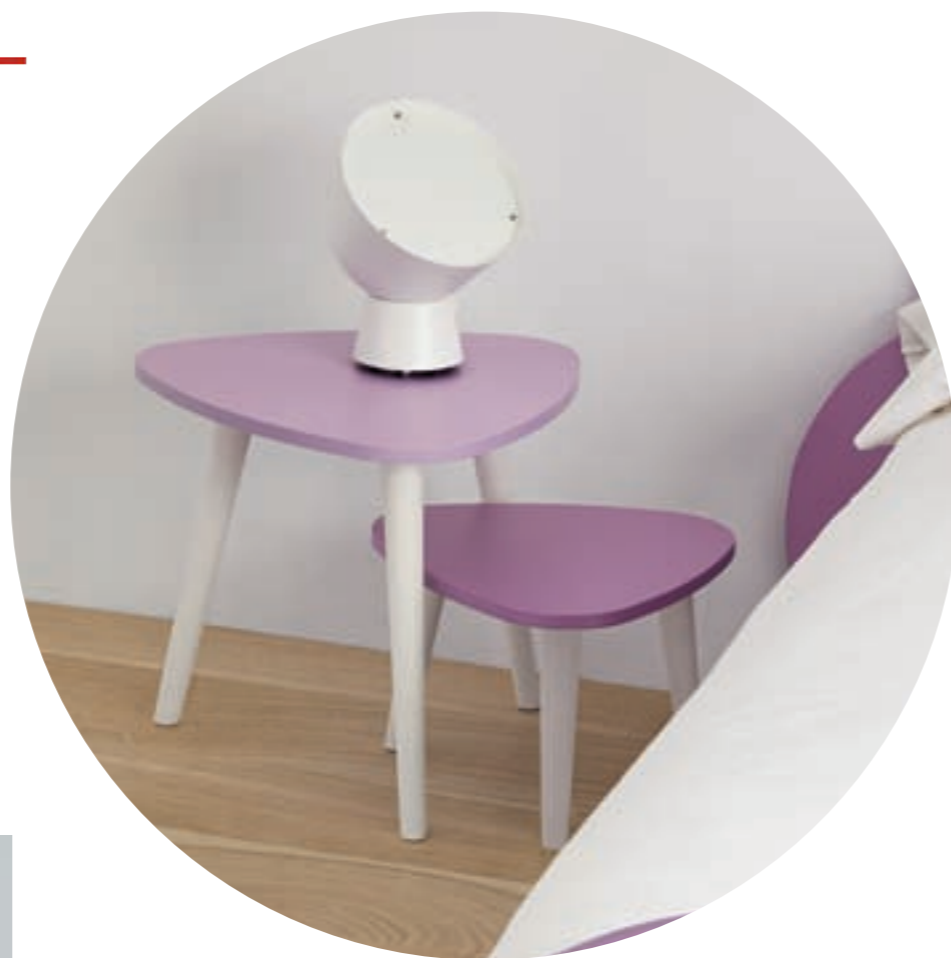

Cuando compartes,
la felicidad se
multiplica por 2.







79

Jugar, dormir, divertirse...
TODO EN UN MISMO ESPACIO.

La cuna con barandilla móvil nos
proporciona una mayor accesibilidad
Seguridad, resistencia y diseño al unísono.

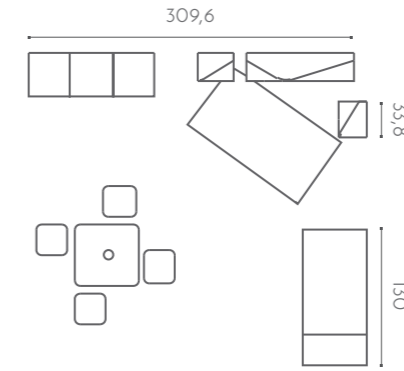

INTERMOBEL



NEW

NOVEDAD



TACTO MADERA

Tiempo para todo.





Cunas adaptables, seguras y modernas.



80

Cambiador con diferentes combinaciones en el interior. Puedes elegir las patas y el interior de entre 3 opciones que te ofrecemos. Combina colores y tiradores a tu gusto.

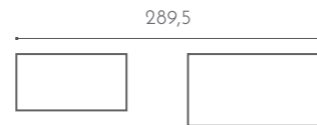

NEW NOVEDAD

TACTO MADERA



muebles
INTERMOBEL





81

Espacio pensado para disfrutar, equivocarse, reinventarse, caerse, levantarse... En definitiva, espacios para ser imparables.

Verde Talco
Azul Pastel



¿Una ludoteca? ¿Una guardería?

muebles
INTERMOBEL





Elige lo que
deseas

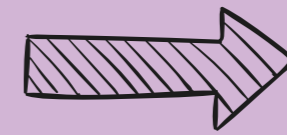

GRUPO
muebles
INTERMOBEL





ACABADOS Y TIRADORES

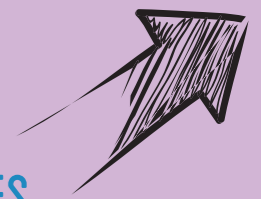

INTERMOBEL



T63



T70



T71



T75



T76

GRUP
D
MUEBLES
INTERMOBEL



T77



T78



T79



T80



T81

TIRADORES

Blanco SR	Arena	Malva
Azul Pastel	Rosa Pastel	Serenity
Turquesa fresh	Canela	Fresa
Verde Pastel	Coral	Violeta
Verde Talco	Musgo	Vino
Kiwi	Rojo	Náutico
Curry	Zanahoria	Gris metal
	Tierra	Antracita

*Todos los tiradores excepto T72- T73 - T74 podrán ir en cualquier color.



Tiradores armario



T83 / T84



T86



T82



T72 (no combinable)



T73 (no combinable)



T74 (no combinable)



Percheros



Perchero metacrilato



Perchero cónico

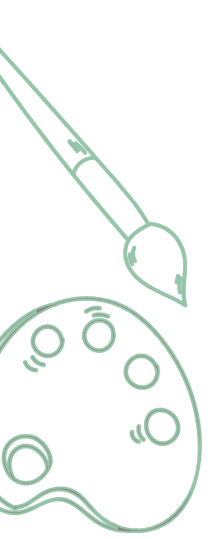

BASES



Barrow



Colorado



Danés



Castello



Tibet



Estocolmo

UNICOLORS

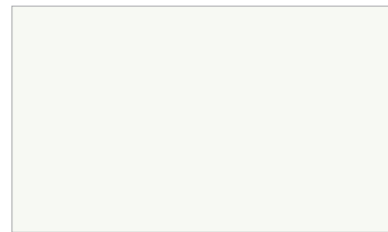

Blanco SR

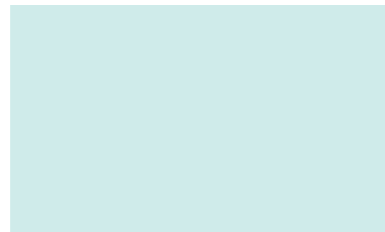

Azul Pastel

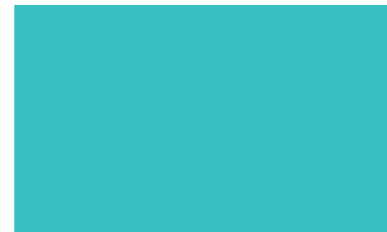

Turquesa fresh

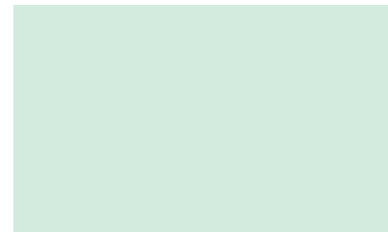

Verde Pastel



Verde Talco



Kiwi



Curry



Arena



Rosa Pastel

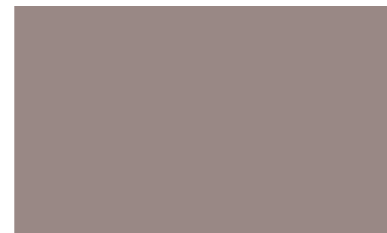

Canela

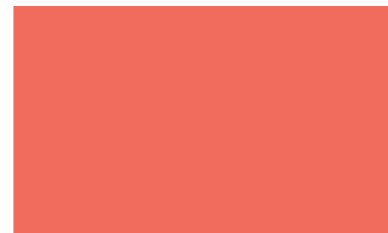

Coral



Musgo



Rojo



Zanahoria



Tierra



Malva



Serenity

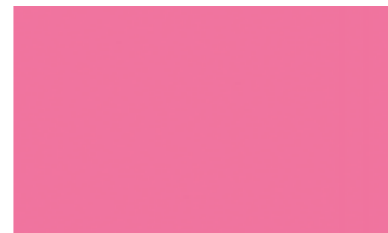

Fresa



Violeta



Vino



Náutico



Gris metal



Antracita



MUESTRARIO DE ACABADOS

VIDRIO



Blanco



Arena



Gris



Antracita

TAPIZADOS



T103



T107



T109



T118



T120



T123



T125



T126



T127



T128



IMPRESIÓN DIGITAL



I-01



I-02



I-03



I-04



I-05



I-07



I-08



I-09



I-10



I-11



I-12



I-06





COMPOSICIONES

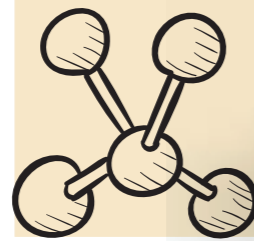

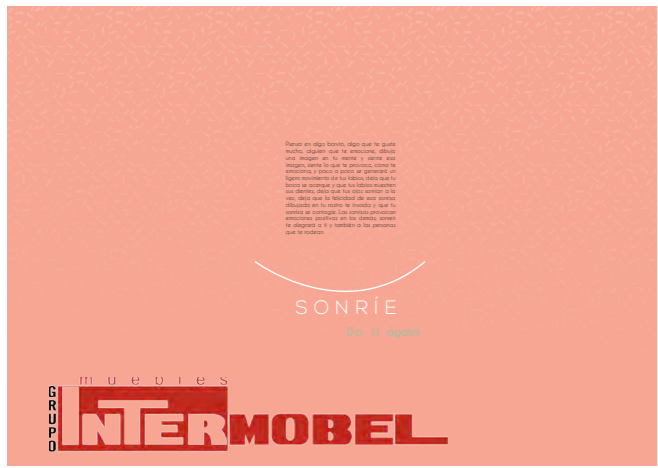

Pág. 06-07



Pág. 8-9



Pág. 18-19



Pág. 20-21



Pág. 22-23



Pág. 24-25



Pág. 34-35



Pág. 36-37



Pág. 38-39



Pág. 40-41



Pág. 52-53



Pág. 54-55



Pág. 56-57



Pág. 58-59



Pág. 10-11

02



Pág. 12-13

03



Pág. 14-15

04



Pág. 16-17

05



Pág. 26-27

10



Pág. 28-29

11



Pág. 30-31

12



Pág. 32-33

13



Pág. 44-45

18



Pág. 46-47

19



Pág. 48-49

20



Pág. 50-51

21



Pág. 60-61



Pág. 62-63

26



Pág. 64-65

27



28

Pág. 66-67



29

Pág. 68-69



30

Pág. 70-71



31

Pág. 72-73



36

Pág. 82-83



37

Pág. 84-85



38

Pág. 86-87



39

Pág. 88-89



44

Pág. 98-99



45

Pág. 100-101



46

Pág. 102-103



47

Pág. 104-105



50

Pág. 112-113



51

Pág. 114-115



52

Pág. 116-117



53

Pág. 118-119



Pág. 74-75

32



Pág. 76-77

33



Pág. 78-79

34



Pág. 80-81

35



Pág. 90-91

40



Pág. 92-93

41



Pág. 94-95

42



Pág. 96-97

43



Pág. 106-107

48



Pág. 108-109

49



Pág. 110-111

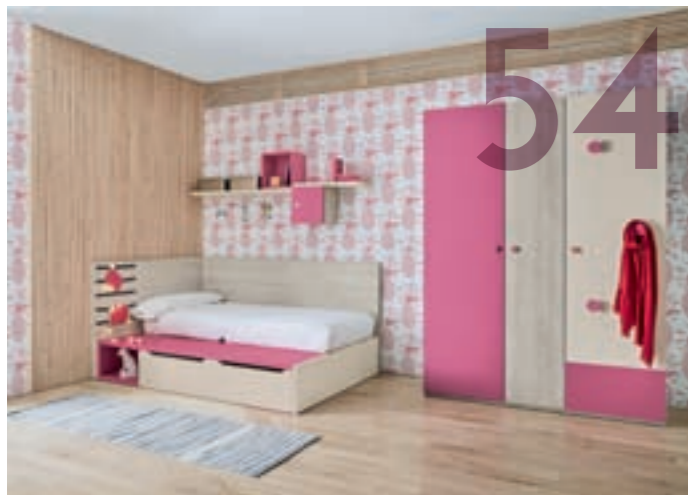

Pág. 120-121

54



Pág. 122-123

55



Pág. 124-125

56



Pág. 126-127

57



58

Pág. 128-129



59

Pág. 130-131



60

Pág. 132-133



61

Pág. 134-135



66

Pág. 144-145



67

Pág. 146-149



68

Pág. 150-151



69

Pág. 152-153



Un nuevo espacio

Pág. 160-161



73

Pág. 162-163



74

Pág. 166-167



75

Pág. 168-171



80

Pág. 182-183



81

Pág. 184-185



Elige lo que deseas

muebles
GRUPO
INTERMOBEL



CREATIVE

ACABADOS Y TIRADORES

Pág. 186-191



62

Pág. 136-137



63

Pág. 138-139



64

Pág. 140-141



65

Pág. 142-143



70

Pág. 154-155



71

Pág. 156-157



72

Pág. 158-159



76

Pág. 172-175



77

Pág. 176-177



78

Pág. 178-179



79

Pág. 180-181

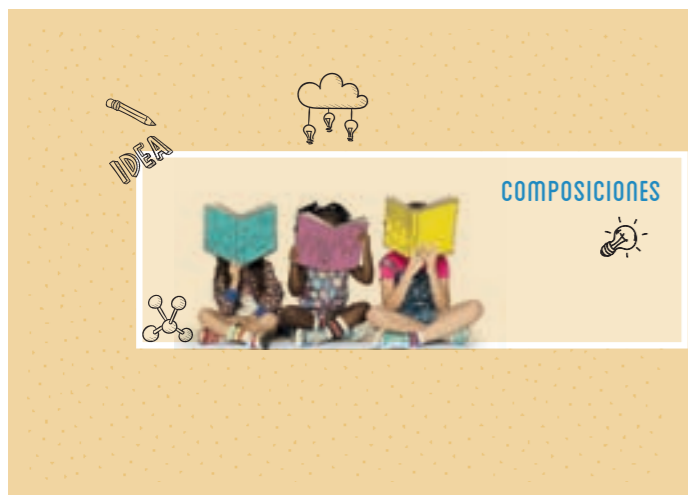

COMPOSICIONES

Pág. 192-199

muebles
INTERMOBEL

SONRÍE 

Desarrollo de producto
Product Development

Muebles Orts



Fotografía
Photography

ángelsegurafoto

Concepto gráfico / Fotomecánica / Impresión
Graphic concept / Photomechanical / Printing

pentagraf

Muebles Orts se reserva el derecho de introducir las modificaciones que considere necesarias en beneficio del producto y del cliente.

Debido a los procesos de impresión, los colores que aparecen en este catálogo deben de considerarse aproximados.

El contenido de este catálogo, está protegido, en su totalidad por copyright.

Queda prohibida la reproducción total o parcial de imágenes y conceptos gráficos, sin la autorización de **Muebles Orts**.

Muebles Orts reserves the right to make changes it deems necessary for the benefit of the product and the customer.

Due to printing processes, colors displayed in this catalog should be considered approximate.

The contents of this catalog is protected by copyright as a whole.

Prohibited the total or partial reproduction of images and graphic concepts, without the authorization of **Muebles Orts**.

Muebles Orts



Polígono Industrial I
Avda. de Alemania, 11
Aptd. Correos, 77
03420 - Castalla - Alicante
ESPAÑA
Telf: +34 966 560 007
Fax: +34 966 560 541
Email: info@mueblesorts.com
Web: www.mueblesorts.com

GRUPO
INTERMOBEL



mueblesorts.com



Do it again!



mueblesorts.com

