

r^o

reyes ordoñez®

muebles
GRUPO **INTERMOBEL**



reyesordóñez®



muebles
GRUPO
INTERMOBEL

Erase una vez, dos hermanos mellizos, Antonio y Fran, que allá por el año 2000 decidieron emprender una aventura llamada Reyes Ordoñez.

Dieciséis años después nos presentan con mucha ilusión, optimismo y humildad su último catálogo. Un proyecto ambicioso y con claros valores, apostando por el diseño, la funcionalidad y sobre todo con la máxima calidad en componentes y acabados.

Así mismo, ofrecen una atención personal y servicio de post venta, con el máximo objetivo de satisfacer las necesidades del cliente.

Gracias a su departamento de diseño y desarrollo, y a la fabricación artesanal de cada pieza, nos ofrecen soluciones personalizadas tanto para el hogar como para el contract.

Os invitamos a sentir la experiencia Reyes Ordoñez...

Once upon a time there was a couple of twin brothers, called Antonio and Fran, who decided to follow their dreams and set out on the adventure that would become Reyes Ordoñez.

Now, 16 years later it is with pride, enthusiasm and optimism they present their newest catalogue. An ambitious project communicating clearly the brothers core values for attention to design, functionality and most important the excellent quality of raw material selection and finished product.

This family run company offers their personal attention with guaranteed after sales service, aiming to meet and satisfy the individual needs of every customer.

The inhouse R&D and design department keeps developing a great variation of unique quality products for the home market as well as bespoke products for the contract market. Modern designs and functions with respect for the craftsmans handmade attention to detail.

Please accept our invitation to enjoy the Reyes Ordoñez experience.





Gemma Madera | 12



Gemma | 16



Botton | 20



Mona | 24

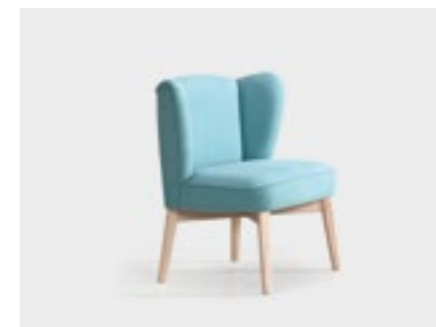

Malik | 28



Malik Capitoné | 28



Bimba | 32



Norik | 34



Norik Balancín | 34



Otto | 36



Ka | 38



Nemo | 40



Mona KIDS | 45



Botton KIDS | 45



Ka KIDS | 46



Malik KIDS | 46



Norik KIDS | 46



Pouffs | 48



Botton Relax | 52



Oliver | 56



Benji | 60



Enzo | 64



Magnum Capitoné | 68



Magnum | 70



Muss | 72



Muss Fibra | 72



Eliot | 76



Chanel | 80



Turbo | 84



Happy | 88



Dumbo | 90



Alcor | 92



Twist | 94



Soul | 94



Magic | 94



Saxo - Saxo Orejero | 98

rô

GRUPO muebles
INTERMOBEL

reyes ordoñez®

BUTACAS





Gemma Madera

Gemma 1 pl.

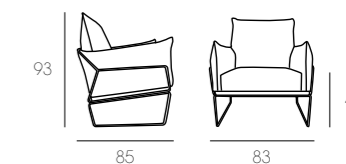

Gemma 2 pl.

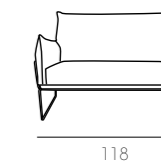

muebles
INTERMOBEL

- Estructura de madera de fresno. Acabados disponibles: Nogal rústico (foto), natural, roble y wengué. *Para colores especiales consultar con fábrica.
- Asiento, respaldo y brazos en goma de alta calidad y totalmente desenfundables.
- Sentada de muelles extra confort.

- Solid ash frame. Available finishes: Rustic walnut (picture), natural, oak stain and wenge stain. *Please contact our factory for customized colours.
- Seat, back and arms in high quality HR foam, removable fabric on all parts.
- Incorporating special springs for extra comfort.

muebles
GRUPO INTERMOBEL

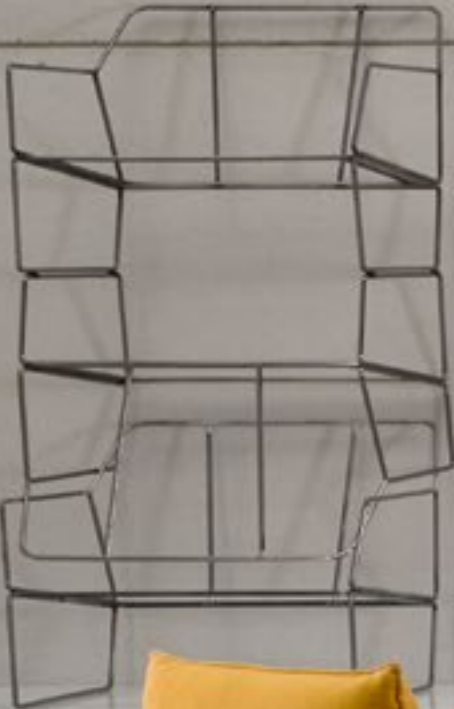



- Estructura en acero pulido o hierro macizo lacado en epoxi. Colores disponibles: Blanco, negro y hierro en bruto (con tratamiento incoloro). *Para colores especiales consultar con fábrica.
- Asiento, respaldo y brazos en goma de alta calidad y totalmente desenfundables.
- Sentada de muelles extra confort.

- Polished steel or epoxy lacquered solid iron frame. Available colours: white, black and raw iron (with clear treatment). *Please contact our factory for customized colours.
- Seat, back and arms in high quality HR foam, removable fabric on all parts.
- Incorporating special springs for extra comfort.

Botton



20|21

muebles
GRUPO INTERMOBEL



Botton

- Estructura de madera de pino y tablero de parfículas.
- Patas, zócalo y botones en madera de haya.
Acabados disponibles: Nogal rústico, natural (foto), roble y wengué. *Para colores especiales consultar con fábrica.
- Asiento, respaldo y cojines desenfundables.

- Frame made of solid pine and high density board.
- Legs, visible frame and buttons made from beech.
Available finishes: Rustic walnut stain, natural (picture), oak stain and wenge stain. *Please contact our factory for customized colours.
- Seat, back and pillows with removable fabric.

GRUPO
INTERMOBEL





Mona

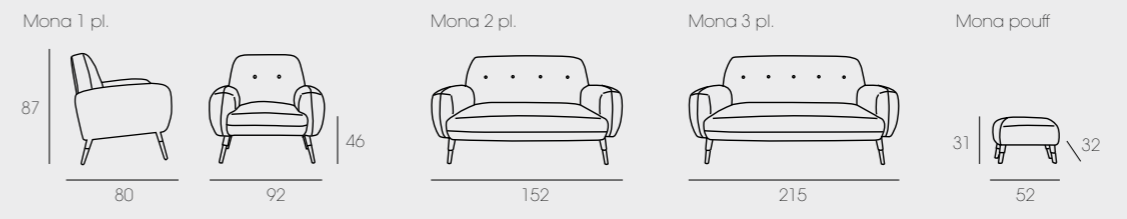

- Estructura de madera de pino y sentada extra confort de muelles.
- Patas en madera de haya. Acabados disponibles: Nogal rústico, natural (foto), roble y wengué. *Para colores especiales consultar con fábrica.
- Goma de alta calidad.

- Solid pine frame. Incorporating special springs for extra comfort.
- Beech legs. Available finishes: Rustic walnut stain, natural (picture), oak stain and wenge stain. *Please contact our factory for customized colours.
- High quality HR foam.



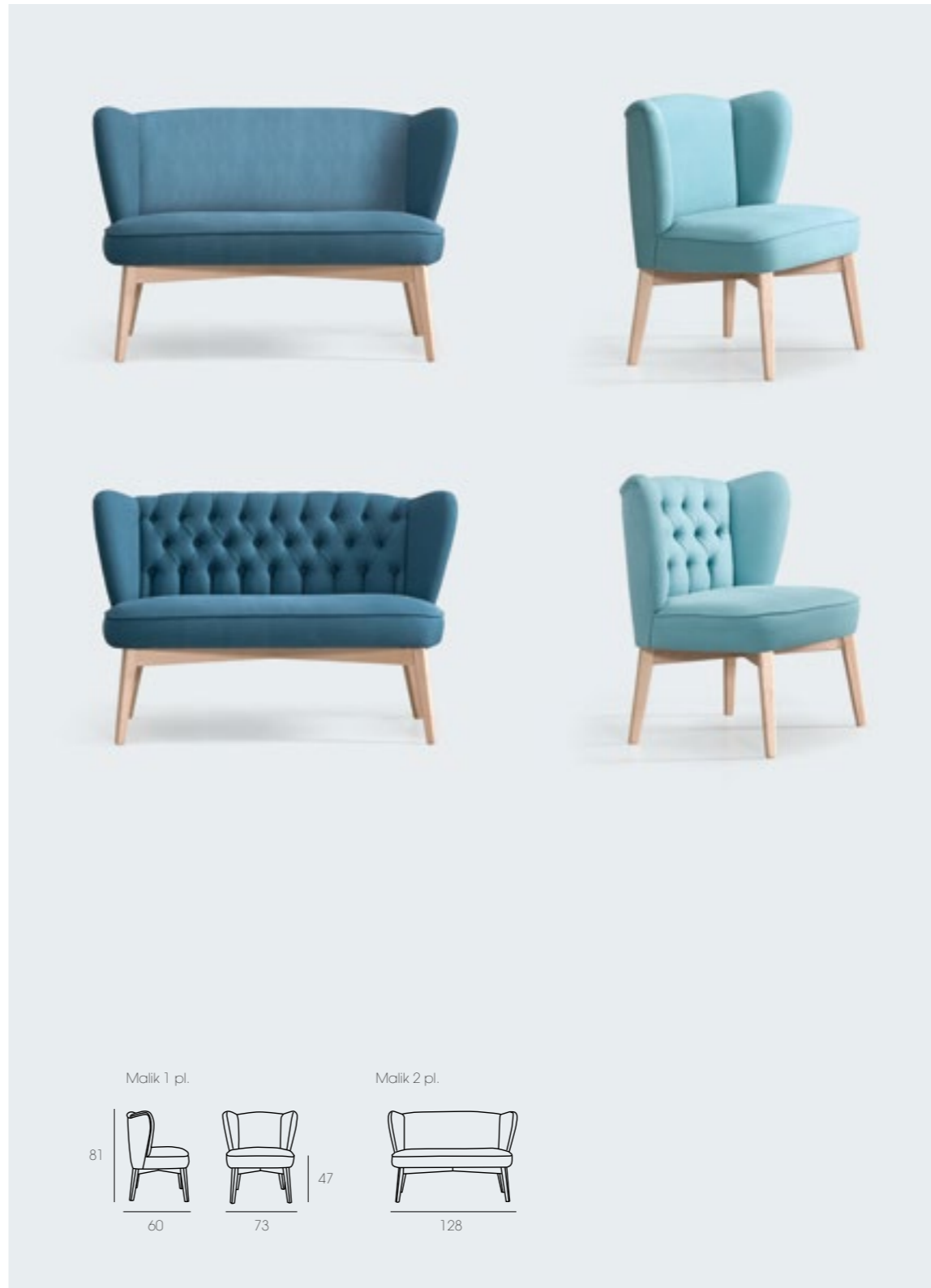

Malik | Malik Capitoné



- Estructura de madera de pino.
- Patas en madera de haya.
- Acabados disponibles: Nogal rústico, natural (foto), roble y wengué. *Para colores especiales consultar con fábrica.
- Goma de alta calidad.

- Solid pine frame.
- Beech legs. Available finishes: Rustic walnut stain, natural (picture), oak stain and wenge stain. *Please contact our factory for customized colours.
- High quality HR foam.

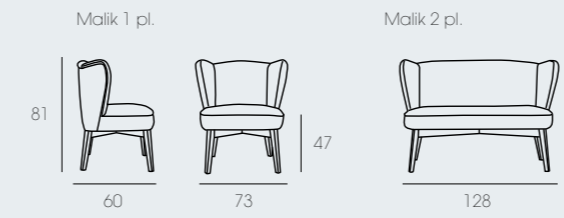



Bimba



Bimba 1 pl.

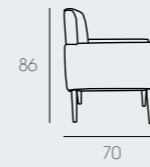

Bimba 2 pl.

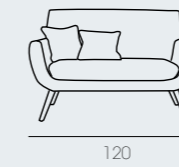

- Estructura de madera de pino.
- Patas en madera de haya. Acabados disponibles: Nogal rústico, natural (foto), roble y wengué.
*Para colores especiales consultar con fábrica.
- Goma de alta calidad.

- Solid pine frame.
- Beech legs. Available finishes: Rustic walnut stain, natural (picture), oak stain and wenge stain. *Please contact our factory for customized colours.
- High quality HR foam.



Norik | Norik Balancín

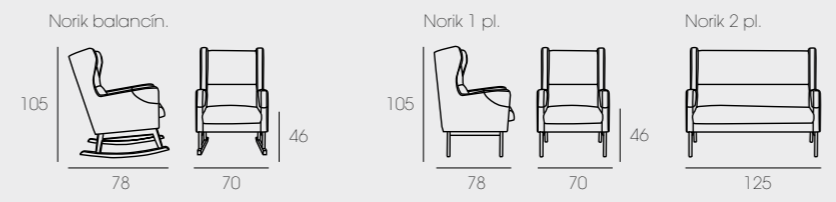

- Estructura de madera de pino.
- Patas en madera de haya. Acabados disponibles: Nogal rústico, natural (foto), roble y wengué. *Para colores especiales consultar con fábrica.
- Goma de alta calidad.

- Solid pine frame.
- Beech legs. Available finishes: Rustic walnut stain, natural (picture), oak stain and wenge stain. *Please contact our factory for customized colours.
- High quality HR foam.



Otto



Otto 1 pl.

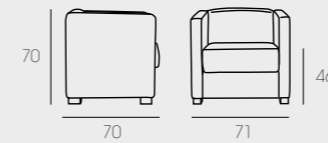

Otto 2 pl.

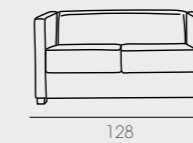

Otto 3 pl.

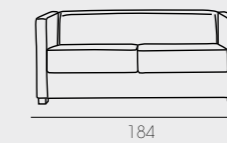

muebles
INTERMOBEL

36|37

- Estructura de madera de pino y tablero de partículas
- Patas en madera de haya. Acabados disponibles: Nogal rústico, natural, roble (foto) y wengué. *Para colores especiales consultar con fábrica.
- Goma de alta calidad.

- Frame made of solid pine and high density board.
- Beech legs. Available finishes: Rustic walnut stains, natural, oak stain (picture) and wenge stain.
- *Please contact our factory for costumized colours.
- High quality HR foam.



Ka



muebles
INTERMOBEL



38|39

Ka 1 pl.

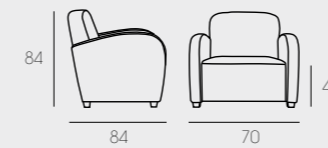

Ka 2 pl.



Ka 3 pl.

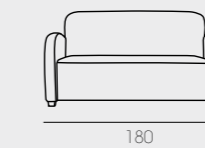

- Estructura de madera de pino y tablero de partículas
- Patas en madera de haya. Acabados disponibles: Nogal rústico, natural (foto), roble y wengué. *Para colores especiales consultar con fábrica.
- Goma de alta calidad.

- Frame made of solid pine and high density board.
- Beech legs. Available finishes: Rustic walnut stains, natural (picture), oak stain and wenge stain.
- *Please contact our factory for customized colours.
- High quality HR foam.



Nemo



Nemo 1 pl.

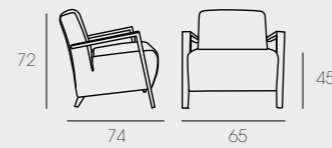

Nemo 2 pl.

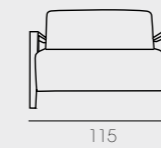

GRUPO
muebles
INTERMOBEL

- Estructura de madera de pino y tablero de partículas
- Patas en madera de haya. Acabados disponibles: Nogal rústico, natural (foto), roble y wengué. *Para colores especiales consultar con fábrica.
- Goma de alta calidad.

- Frame made of solid pine and high density board.
- Beech legs. Available finishes: Rustic walnut stains, natural (picture), oak stain and wenge stain. *Please contact our factory for customized colours.
- High quality HR foam.





muebles
INTERMOBEL



Botton Kids

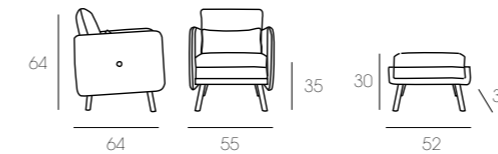

- Estructura de madera de pino y tablero de partículas.
- Patas, zócalo y botones en madera de haya. Acabados disponibles: Nogal rústico, natural (foto), roble y wengué. *Para colores especiales consultar con fábrica.
- Asiento, respaldo y cojines desfundables.

- Frame made of solid pine and high density board.
- Legs, visible frame and buttons made from beech. Available finishes: Rustic walnut stain, natural (picture), oak stain and wenge stain. *Please contact our factory for customized colours.
- Seat, back and pillows with removable fabric.

Mona Kids

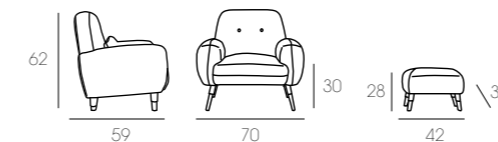

- Estructura de madera de pino.
- Patas en madera de haya. Acabados disponibles: Nogal rústico (foto), natural, roble y wengué. *Para colores especiales consultar con fábrica.
- Goma de alta calidad.

- Solid pine frame.
- Beech legs. Available finishes: Rustic walnut stain (picture), natural, oak stain and wenge stain. *Please contact our factory for customized colours.
- High quality HR foam.



Ka Kids

Norik Balancín Kids



Malik Kids

Norik Balancín Kids

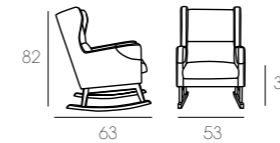

- Estructura de madera de pino.
- Patas en madera de haya. Acabados disponibles: Nogal rústico, natural (foto), roble y wengué. *Para colores especiales consultar con fábrica.
- Goma de alta calidad.

- Solid pine frame.
- Beech legs. Available finishes: Rustic walnut stain, natural (picture), oak stain and wenge stain. *Please contact our factory for customized colours.
- High quality HR foam.

Ka Kids

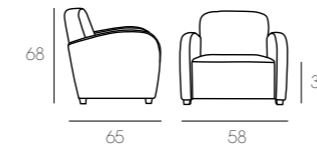

- Estructura de madera de pino y tablero de partículas
- Patas en madera de haya. Acabados disponibles: Nogal rústico, natural (foto), roble y wengué. *Para colores especiales consultar con fábrica.
- Goma de alta calidad.

- Frame made of solid pine and high density board.
- Beech legs. Available finishes: Rustic walnut stains, natural (picture), oak stain and wenge stain. *Please contact our factory for customized colours.
- High quality HR foam.

Malik Kids

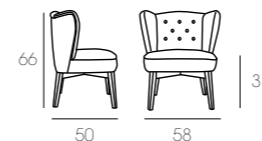

- Estructura de madera de pino.
- Patas en madera de haya. Acabados disponibles: Nogal rústico, natural (foto), roble y wengué. *Para colores especiales consultar con fábrica.
- Goma de alta calidad.

- Solid pine frame.
- Beech legs. Available finishes: Rustic walnut stain, natural (picture), oak stain and wenge stain. *Please contact our factory for customized colours.
- High quality HR foam.



POUFFS



Pouff Capitoné

Ø 80 x 35 (alto)
Ø 100 x 35 (alto)



Pouff Liso

Ø 80 x 35 (alto)
Ø 100 x 35 (alto)



Pouff Capitoné

80 x 80 x 35 (alto)
100 x 100 x 35 (alto)
100 x 60 x 35 (alto)



Pouff Liso

80 x 80 x 35 (alto)
100 x 100 x 35 (alto)
100 x 60 x 35 (alto)

rõ

muebles
INTERMOBEL

reyes ordoñez®

X
A
E
R

GRUPPO MUEBLES
INTERMOBEL





Botton Relax

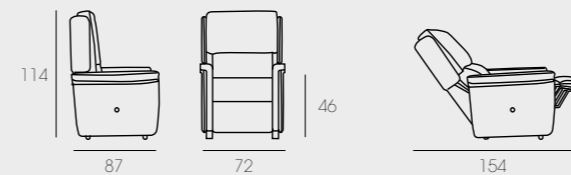

GRUPO MUEBLES **INTERMOBEL**

54|55

OPCIONES DE MECANISMO



Relax Manual



Apertura motorizada

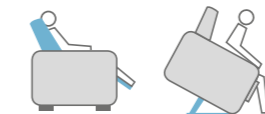

Power Lift 1 Mot.*



Power Lift 2 Mot.*

EXTRAS DISPONIBLES



Batería



Kit Calefacción



Botonera



Mando con cable



Cubrebrazos



Cubrecabeza

* Este mecanismo eleva al usuario 10 cm. en vertical para luego incorporarlo hacia delante





Oliver



muebles
INTERMOBEL



58|59

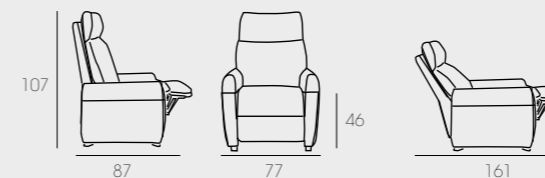

OPCIONES DE MECANISMO



Relax Manual



Apertura motorizada

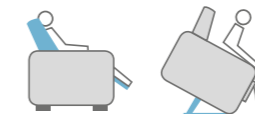

Power Lift 1 Mot.*



Cubrebraos de serie

EXTRAS DISPONIBLES



Roller System



Bateria



Kit Calefacción



Botonera



Mando con cable



Cubrecabeza

* Este mecanismo eleva al usuario 10 cm. en vertical para luego incorporarlo hacia delante





Benji

62|63

OPCIONES DE MECANISMO



Relax Manual



Apertura motorizada

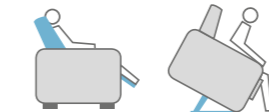

Power Lift 1 Mot.*



Power Lift 2 Mot.*

EXTRAS DISPONIBLES



Roller System

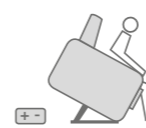

Batería

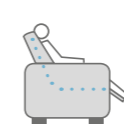

Kit Calefacción

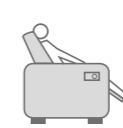

Botonera



Mando con cable

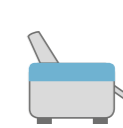

Cubrebrazos



Cubrecabeza

* Este mecanismo eleva al usuario 10 cm. en vertical para luego incorporarlo hacia delante





Enzo

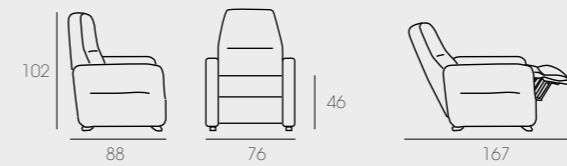

muebles
INTERMOBEL

66|67

OPCIONES DE MECANISMO



Relax Manual



Apertura motorizada

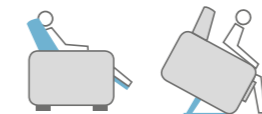

Power Lift 1 Mot.*



Power Lift 2 Mot.*

EXTRAS DISPONIBLES



Roller System

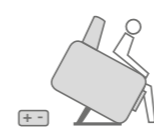

Batería



Kit Calefacción



Sistema Lumbar

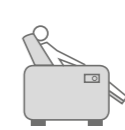

Botonera



Mando con cable

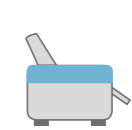

Cubrebrazos

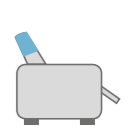

Cubrecaabeza

* Este mecanismo eleva al usuario 10 cm. en vertical para luego incorporarlo hacia delante



Magnum Capitoné



OPCIONES DE MECANISMO



Giratorio y Balancín



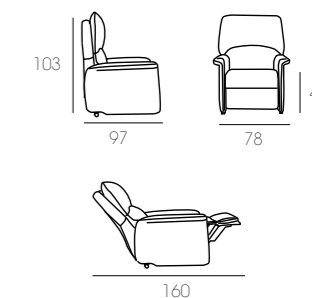

74|75

OPCIONES DE MECANISMO



Relax Manual



Apertura motorizada

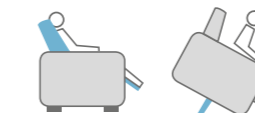

Power Lift 1 Mot.*

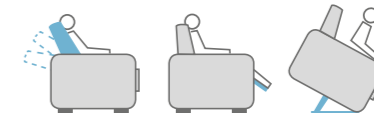

Power Lift 2 Mot.*

EXTRAS DISPONIBLES



Roller System



Batería



Kit calefacción



Botonera



Mando con cable



Cubrebrazos



Cubrecabeza

* Este mecanismo eleva al usuario 10 cm. en vertical para luego incorporarlo hacia delante

Eliot



76|77



Eliot

78|79

OPCIONES DE MECANISMO



Relax Manual



Giratorio y Balancín



Apertura motorizada



Giratorio y Balancín motorizado



Power Lift 1 Mot.

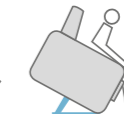

Power Lift 2 Mot.

EXTRAS DISPONIBLES

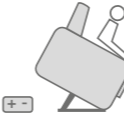

Batería



Botonera



Mando con cable



Cubrebrazos



Cubrecabeza



Chanel

muebles
INTERMOBEL



Chanel

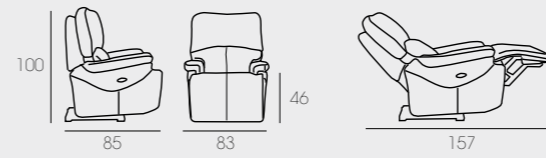

OPCIONES DE MECANISMO



Relax Manual



Giratorio y Balancín



Apertura motorizada



Giratorio y Balancín motorizado



Power Lift 1 Mot.



Power Lift 2 Mot.

EXTRAS DISPONIBLES

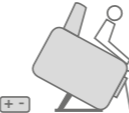

Batería



Botonera



Mando con cable



Cubrebrazos



Cubrecabeza

Turbo

84|85





Turbo



muebles
GRUPO INTERMOBEL

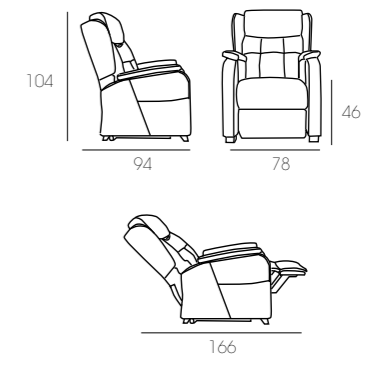

86|87

OPCIONES DE MECANISMO



Relax Manual



Apertura motorizada

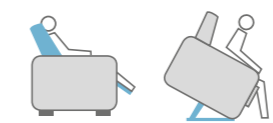

Power Lift 1 Mot.*



Power Lift 2 Mot.*

EXTRAS DISPONIBLES



Roller System

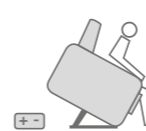

Bateria

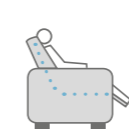

Kit calefacción



Botonera



Mando con cable



Cubrebrazos

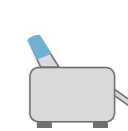

Cubrecabeza

* Este mecanismo eleva al usuario 10 cm. en vertical para luego incorporarlo hacia delante



Happy

muebles
INTERMOBEL

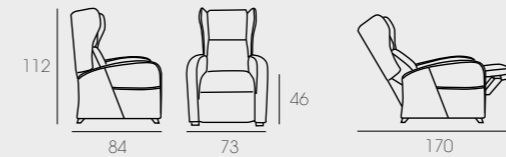

88|89

OPCIONES DE MECANISMO



Relax Manual



Apertura motorizada

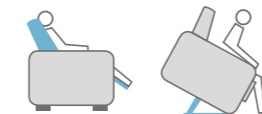

Power Lift 1 Mot.*



Power Lift 2 Mot.*

EXTRAS DISPONIBLES



Roller System



Batería

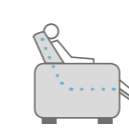

Kit calefacción

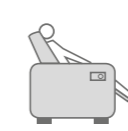

Botonera



Mando con cable

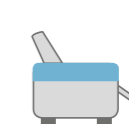

Cubrebrazos

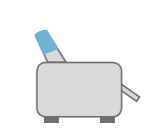

Cubrecabeza

* Este mecanismo eleva al usuario 10 cm. en vertical para luego incorporarlo hacia delante



Dumbo



90|91

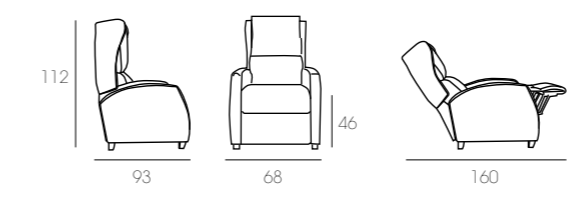

OPCIONES DE MECANISMO



Relax Manual



Apertura motorizada



Power Lift 1 Mot.*

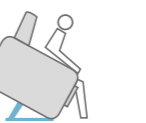

Power Lift 2 Mot.*

EXTRAS DISPONIBLES



Roller System

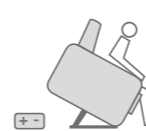

Bateria

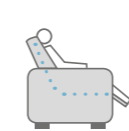

Kit calefacción



Botonera



Mando con cable

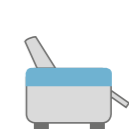

Cubrebrazos

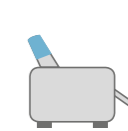

Cubrecabeza

* Este mecanismo eleva al usuario 10 cm. en vertical para luego incorporarlo hacia delante



Alcor



92|93

OPCIONES DE MECANISMO



Relax Manual



Apertura motorizada



Power Lift 1 Mot.*



Power Lift 2 Mot.*

EXTRAS DISPONIBLES



Roller System

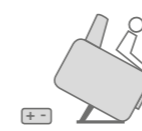

Batería



Kit calefacción



Botonera



Mando con cable



Cubrebrazos

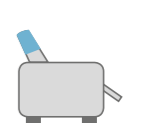

Cubrecabeza

* Este mecanismo eleva al usuario 10 cm. en vertical para luego incorporarlo hacia delante

muebles
INTERMOBEL





Magic



Soul



Twist

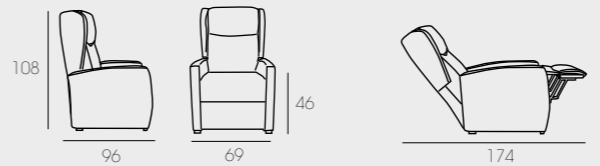
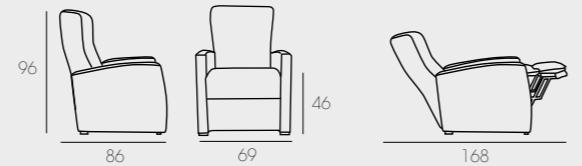
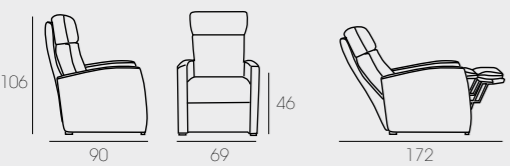

OPCIONES DE MECANISMO



Relax Manual



Apertura motorizada

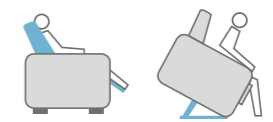

Power Lift 1 Mot.*

EXTRAS DISPONIBLES



Roller System

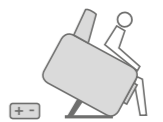

Batería

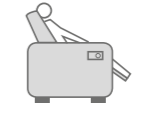

Pulsador Brazo



Mando con cable

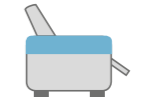

Cubrebrazos



Cubrecabeza

* Este mecanismo eleva al usuario 10 cm. en vertical para luego incorporarlo hacia delante





OPCIONES DE MECANISMO



Relax Manual



Apertura motorizada

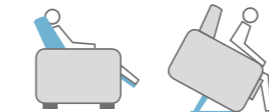

Power Lift 1 Mot.



Power Lift 2 Mot.*

EXTRAS DISPONIBLES



Roller System

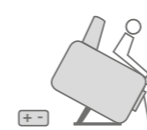

Batería



Botonera



Mando con cable



Cubrebraços



Cubrecabeza

* Este mecanismo tiene una posición de apertura máxima dejando la altura de las piernas ligeramente por encima del nivel del corazón (mejorando el riego sanguíneo)



GRUPO **muebles**
INTERMOBEL

reyesordonez[®]

Polígono Industrial "Las Teresas"
C/ Pedro Pons, 2
30510 YECLA (Murcia) España
Telf. 968 75 28 85 - Fax 968 75 29 95
info@reyesordonez.com
www.reyesordonez.es

rõ

reyes ordoñez®

GRUPO m u e d i e s **INTERMOBEL**