

# TECNIKA

ARMARIOS | WARDROBES | ARMOIRES

meseque®

GRUPO  
INTERMOBEL



# TECNIKA

ARMARIOS | WARDROBES | ARMOIRES

## DISEÑO, CALIDAD Y FUNCIONALIDAD

TECNIKA es un programa de armarios de diseño moderno y elegante, con claros matices tecnológicos que ofrecen propuestas de gran flexibilidad y estilo. En este catálogo encontrarás múltiples ideas para construir tu armario a medida. Destacamos los acabados exteriores de chapa natural que combinados con nuestra gran variedad de colores en lacado mate, combinan a la perfección con nuestros interiores más exclusivos.

## DESIGN, QUALITY AND FUNCTIONALITY

TECNIKA is a program of cabinets with a modern and elegant design, with clear technological nuances that offer proposals of great flexibility and style. In this catalog you will find multiple ideas to build your custom wardrobe. We highlight the natural veneer exterior finishes that, combined with our wide variety of matt lacquered colors, combine perfectly with our most exclusive interiors.

## DESIGN, QUALITÉ ET FONCTIONNALITÉ

TECNIKA est un programme d'armoires de design moderne et élégant, avec des claires nuances technologiques qui offrent des propositions de grande flexibilité et style. Dans ce catalogue, vous trouverez de nombreuses idées pour construire votre armoire sur mesure. Nous soulignons les finitions extérieures de placage naturel, qui combinées avec notre grande variété de couleurs laquage mat, combinent à la perfection avec nos intérieurs les plus exclusifs.

**mesegue®**





## HISTORIA

Muebles Mesegue somos una marca reconocida en la fabricación de muebles en chapa natural y lacados para dormitorios y salones de diseño moderno. Nuestra larga experiencia y profesionalidad nos permite innovar y ofrecer productos de la más alta calidad. No obstante, nuestra misión va más allá de fabricar, creamos soluciones para el hogar. Creemos en la investigación, en el estudio de soluciones estéticas que puedan integrarse con las necesidades funcionales de un espacio cotidiano.

m

## HISTORY

Muebles Mesegue is a recognized brand in the manufacture of natural veneer and lacquered furniture for bedrooms and living rooms of modern design. Our long experience and high professionalism allow us to innovate and offer products of the highest quality. However, our mission goes beyond manufacturing, we create solutions for the home. We believe in research, in the study of aesthetic solutions that can be integrated with the functional needs of an everyday space.

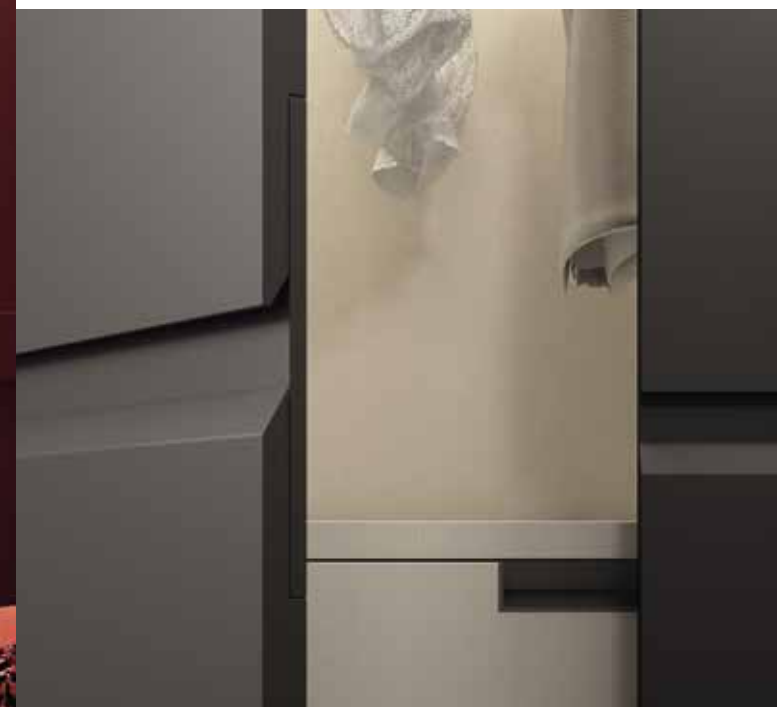

## HISTOIRE

Muebles Mesegue est une marque reconnue dans la fabrication de meubles de placage naturel et laqués pour des chambres et salons de design moderne. Notre longue expérience et grand professionnalisme nous permet d'innover et d'offrir des produits de la plus haute qualité. Cependant, notre mission va au delà de fabriquer, nous créons des solutions pour le foyer. Nous croyons en la recherche, en l'étude de solutions esthétiques qui puissent s'intégrer à la nécessité fonctionnelle d'un espace quotidien.





**ACABADOS**  
FINISHES | FINITIONS



**6**

**REALLY**

ARMARIOS VESTIDORES  
DRESSING WARDROBES  
ARMOIRES DRESSING

**20**

**LINE**

ARMARIOS PUERTAS BATIENTES  
SWING DOORS WARDROBES  
ARMOIRES À PORTES BATTANTES

**62**

**DINAMIC**

ARMARIOS SINGULARES  
UNIQUE WARDROBES  
ARMOIRES UNIQUES

**82**

**MOVIE**

ARMARIOS CORREDERAS  
SLIDING WARDROBES  
ARMOIRES COULISSANTES

**112**

**COMPLEMENTOS**

ACCESSORIES | ACCESSOIRES

COMPLEMENTOS ARMARIOS  
WARDROBES ACCESSORIES  
ACCESSOIRES D'ARMOIRES

**118**

**PUERTAS**

DOORS | PORTES

TIPOS DE PUERTAS DE ARMARIOS  
TYPES OF WARDROBES DOORS  
TYPES DE PORTES D'ARMOIRES

**120**

**COMPOSICIONES**

COMPOSITIONS | COMPOSITIONS

RESUMEN DE COMPOSICIONES  
COMPOSITION SUMMARY  
RÉSUMÉ DES COMPOSITIONS

**126**

**ACABADOS**

FINISHES | FINITIONS

CHAPA DE MADERA NATURAL Y LACADOS  
NATURAL WOOD VENEER AND LACQUER  
PLACAGE DE BOIS NATUREL ET LAQUÉS



MUEBLES  
**INTERMOBEL**

# REALLY

VESTIDORES

DRESSING WARDROBES  
ARMOIRES DRESSING









**REALLY 100**

L482,2 H240 F58

ACABADO  
FINISH | FINITION

OREGÓN  
ESTAMPADO FLORAL



**VESTIDOR REALLY METAL**

El vestidor Really es un armario totalmente abierto, con lados de estructura metálica en acabado sombra para dar un efecto de mayor amplitud visual. Iluminado con luz led en los estantes superiores que realzan el acabado estampado floral de la trasera.

**DRESSING ROOM REALLY METAL**

The Really walk-in closet is a totally open wardrobe, with metal frame sides in a shadow finish to give an effect of greater visual amplitude. Illuminated with led light on the upper shelves that enhance the floral print finish on the back.

**DRESSING REALLY METAL**

Le dressing Really est un armoire totalement ouvert, avec les côtés d'une structure métallique en finition ombre pour donner un effet de majeure amplitude visuelle. Illuminé avec une lumière LED dans les étagères supérieures qui rehaussent la finition de l'imprimé floral de la plaque arrière.



# REALLY 100

VARIANTES VARIANTS | VARIANTES

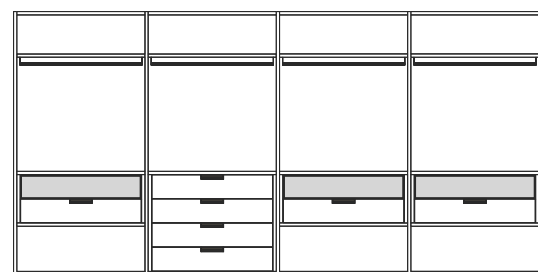

**REALLY 100-1**  
L482,2 H240 F58

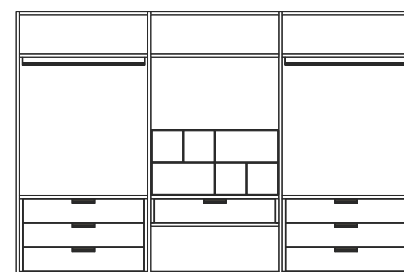

**REALLY 100-2**  
L362,4 H240 F58

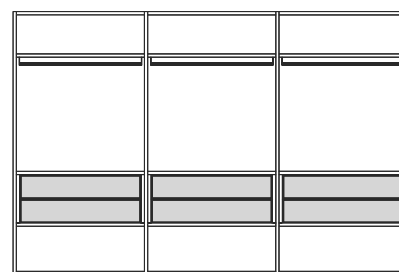

**REALLY 100-3**  
L362,4 H240 F58

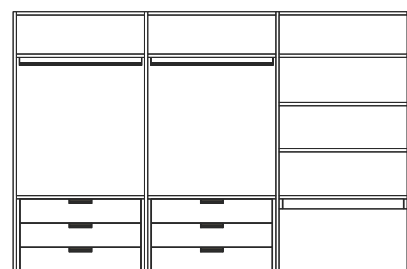

**REALLY 100-4**  
L362,4 H240 F58

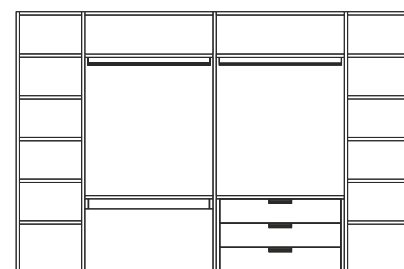

**REALLY 100-5**  
L362,6 H240 F58

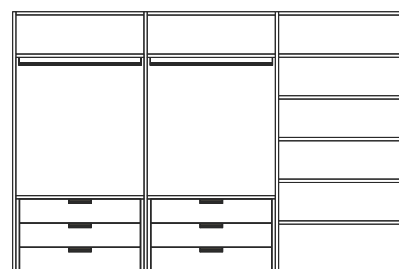

**REALLY 100-6**  
L362,4 H240 F58

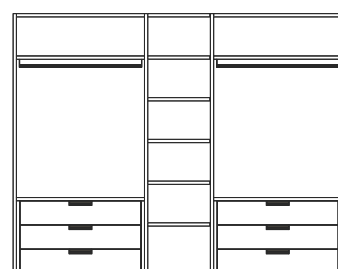

**REALLY 100-7**  
L302,6 H240 F58

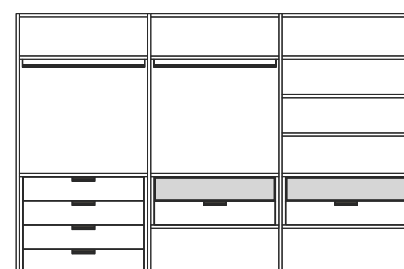

**REALLY 100-8**  
L362,4 H240 F58

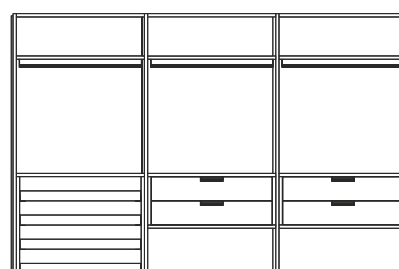

**REALLY 100-9**  
L362,4 H240 F58

## EJEMPLOS DE COMBINACIÓN

El sistema de vestidores Really puede construirse como un armario tradicional. Aquí te mostramos alguna de estas combinaciones para darte ideas para diseñar el tuyo.

## COMBINATION EXAMPLES

The Really dressing system can be built like a traditional closet. Here we show you some of these combinations to give you ideas to design yours.

## EXEMPLES DE COMBINAISON

Le système des dressing Really peut se construire comme une garde-robe traditionnelle. Ici nous vous montrons quelques-unes de ces combinaisons pour vous donner des idées pour concevoir le votre.



# REALLY 101

L362,6 H240 F60,5

ACABADO FINISH | FINITION BLANCO | OREGÓN



## REALLY 101

L362,6 H240 F60,5

ACABADO  
FINISH | FINITION

BLANCO | OREGÓN



## VESTIDOR REALLY CON CAJONES VISTOS

Hemos incorporado al armario vestidor unos cajones de gran capacidad adaptados a la propia estructura para darte el servicio de cómoda en el propio vestidor. Puedes pedir el acabado de estos cajones en chapa natural o laca mate.

## REALLY DRESSING ROOM WITH EXPECTED DRAWERS

We have incorporated into the walk-in closet some large capacity drawers adapted to the structure itself to give you the service of a chest of drawers in the walk-in closet itself. You can order the finish of these drawers in natural veneer or matt lacquer.

## DRESSING REALLY AVEC TIROIRS VISIBLES

Nous avons incorporé au dressing quelques tiroirs de grande capacité adaptés à la propre structure pour vous donner le service de commode dans le propre dressing. Vous pouvez demander la finition de ces tiroirs en placage naturel ou laquage mat.







# REALLY 102

VARIANTES VARIANTS | VARIANTES

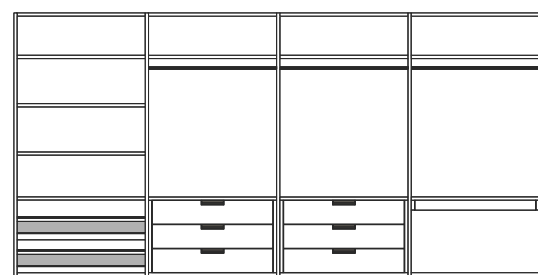

**REALLY 102-1**  
L482,2 H240 F58

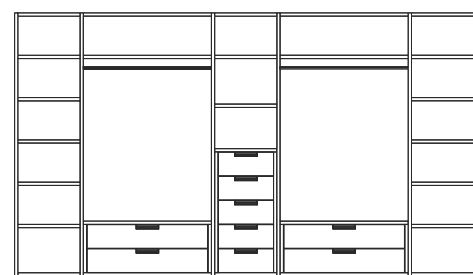

**REALLY 102-2**  
L422,6 H240 F58



**REALLY 102-3**  
L362,6 H240 F58

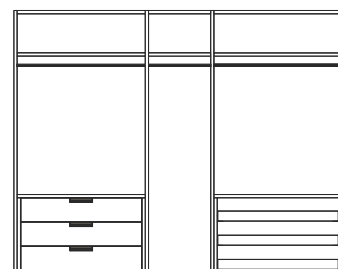

**REALLY 102-4**  
L302,6 H240 F58

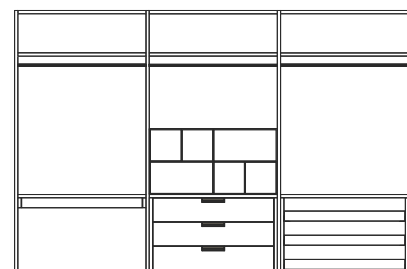

**REALLY 102-5**  
L362,4 H240 F58

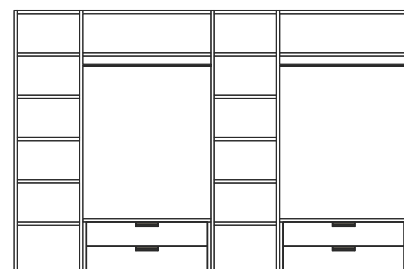

**REALLY 102-6**  
L362,6 H240 F58

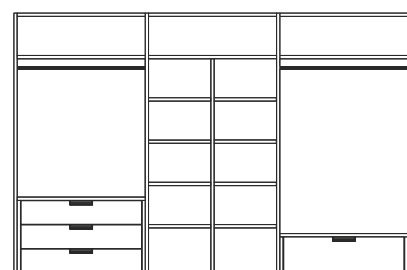

**REALLY 102-7**  
L362,4 H240 F58

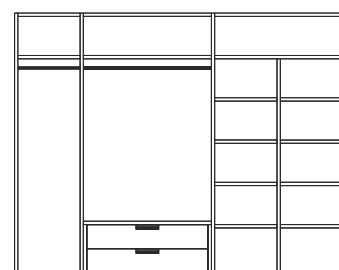

**REALLY 102-8**  
L302,6 H240 F58

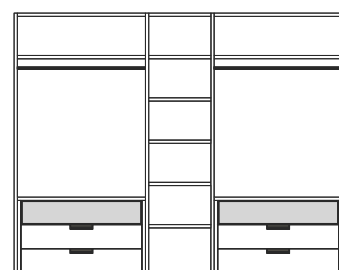

**REALLY 102-9**  
L302,6 H240 F58

## EJEMPLOS DE COMBINACIÓN

El sistema de vestidores Really puede construirse como un armario tradicional. Aquí te mostramos alguna de estas combinaciones para darte ideas para diseñar el tuyo.

## COMBINATION EXAMPLES

The Really dressing system can be built like a traditional closet. Here we show you some of these combinations to give you ideas to design yours.

## EXEMPLES DE COMBINAISON

Le système des dressing Really peut se construire comme une garde-robe traditionnelle. Ici nous vous montrons quelques-unes de ces combinaisons pour vous donner des idées pour concevoir la votre.

## VESTIDOR REALLY MADERA

Solución de armario vestidor con lados de madera construido con gruesos de 3 cm. Se ofrece en 3 alturas y puedes modular al ancho que necesites a medida sin incremento de precio. Ofrecemos una amplia variedad complementos interiores para que puedas organizar a tu gusto todo el interior.

## MIXED REALLY DRESSING ROOM

This time we close with 3 cm wooden sides. On the sides of the wardrobe, we put central dividers with a metallic structure to give the dressing room greater visual amplitude.

## DRESSING REALLY BOIS

Solution d'armoires dressing avec côtés en bois construit avec une épaisseur de 3 cm. Nous vous offrons 3 hauteurs et vous pouvez modular la largeur dont vous avez besoin sans augmenter le prix. Nous vous offrons une ample variété de compléments intérieurs pour que vous puissiez organiser à votre goût tout l'intérieur.

# REALLY 102

ACABADO FINISH | FINITION Oregón | ESTAMPADO DORADO



## REALLY 102

L482,2 H240 F58

ACABADO  
FINISH | FINITION

OREGÓN  
ESTAMPADO DORADO



GRUPO  
**INTERMOBEL**



# REALLY 103

L482,2 H240 F58

ACABADO FINISH | FINITION BEIGE | ESTAMPADO FLORAL



GRUPO  
MUEBLES  
**INTERMOBEL**

## REALLY 103

L482,2 H240 F58

ACABADO  
FINISH | FINITION

BEIGE  
ESTAMPADO FLORAL



### VESTIDOR REALLY MIXTO

En esta ocasión cerramos con costados de madera de 3 cm. los laterales del armario pero ponemos partidores centrales con estructura metálica para dar mayor amplitud visual al vestidor.

### MIXED REALLY DRESSING ROOM

This time we close with 3 cm wooden sides. the sides of the wardrobe but we put central partitions with a metal structure to give the dressing room greater visual amplitude.

### DRESSING REALLY MIXTE

Cette fois-ci nous fermons les latéraux de l'armoire avec des côtés en bois de 3 cm mais nous ajoutons des diviseurs centraux avec une structure métallique pour donner une majeure amplitude visuelle au dressing.



BATIENTES

**LINE**

**BATIENTES**

SWINGERS DOORS  
PORTES BATTANTES

m

INTERMOBEL

mesegue®



**HALF 200**

L359,6 H240 F60,5

MOSTAZA

INTERIOR INSIDE | INTÉRIEUR OREGÓN

GRUPPO  
HUBBIES  
**INTERMOBEL**





## HALF 200

MOSTAZA

INTERIOR INSIDE | INTÉRIEUR OREGÓN

muebles  
**INTERMOBEL**



## HALF 200

L359,6 H240 F60,5

**APERTURA**  
SWING | OUVERTURE

BATIENTE

**PUERTAS**  
DOORS | PORTES

HALF | LISA

COMPLET



BASIC



## HALF 201

L240 H240 F60,5

PERLA | NOGAL AMERICANO

INTERIOR INSIDE | INTÉRIEUR BEIGE



## HALF 201

L240 H240 F60,5

**APERTURA**  
SWING | OUVERTURE

BATIENTE

**PUERTAS**  
DOORS | PORTES

HALF | LISA

COMPLET



BASIC



HALF

En la foto izquierda: Armario batiente con puerta HALF lacada en Mostaza donde queda el tirador totalmente integrado. En la foto derecha: Puerta HALF en acabado lacado Perla que contrasta con el tirador de chapa natural Nogal Americano.

In the left photo: Hinged wardrobe with Mostaza lacquered HALF door where the fully integrated handle remains. In the right photo: HALF door in Perla lacquered finish that contrasts with the natural Nogal Americano veneer.

Sur la photo de gauche: Armoire battant avec la porte HALF laquée en Mostaza où la poignée est totalement intégrée. Sur la photo de droite: Porte HALF en finition laquée Perla qui contraste avec la poignée de placage naturel Bois de Nogal Americano.







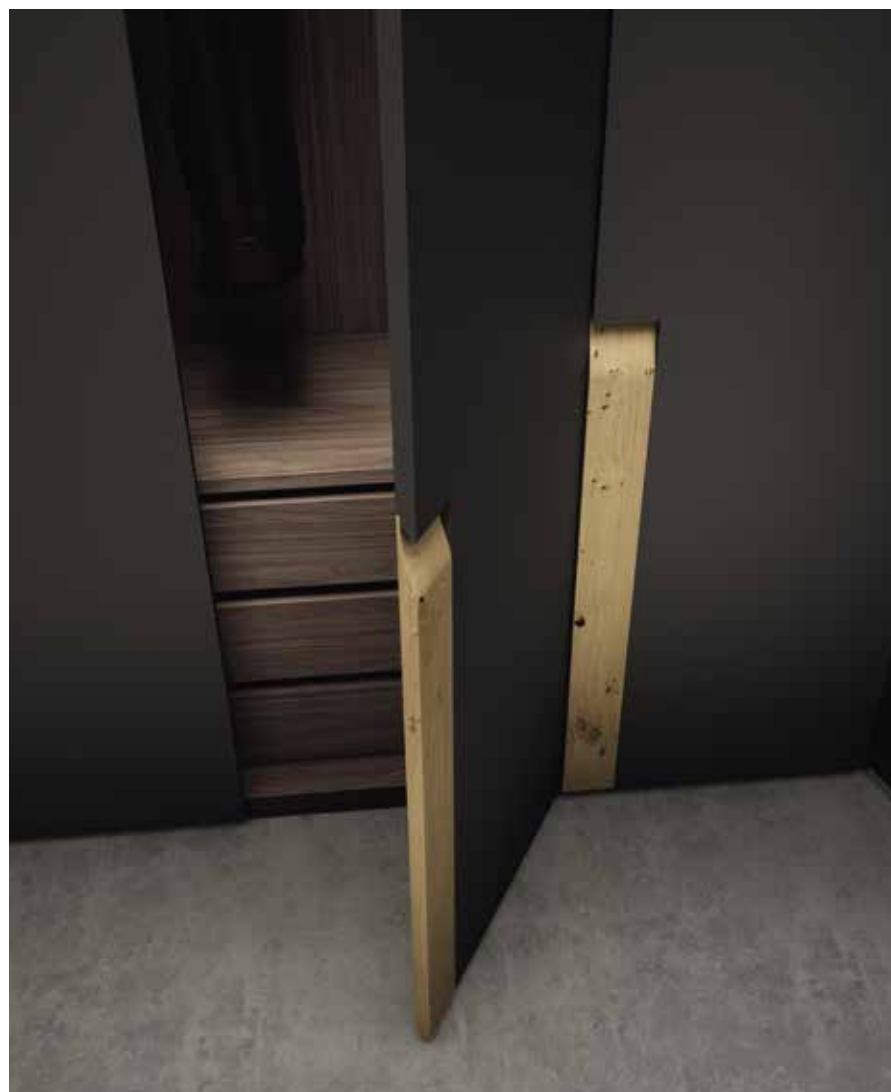

**TRAMA**

Armario batiente con puerta TRAMA lacada en color Sombra y tirador de chapa natural Oak Nudos.

Hinged wardrobe with TRAMA door lacquered in Sombra color and Oak Nudos natural veneer handle.

Armoire battant avec la porte TRAMA laquée en couleur Sombre et poignée de placage naturel Oak Nudos.

**TRAMA 202**

L299,9 H240 F60,5

**APERTURA**  
SWING | OUVERTURE

BATIENTE

**PUERTAS**  
DOORS | PORTES

TRAMA | LISA

**COMPLET**



**BASIC**





## NORMA 203

L240 H240 F60,5

BLANCO

INTERIOR INSIDE | INTÉRIEUR BEIGE



GRUPO  
MUEBLES  
**INTERMOBEL**

### NORMA 203

L240 H240 F60,5

**APERTURA**  
SWING | OUVERTURE

BATIENTE

**PUERTAS**  
DOORS | PORTES

NORMA

**TIRADOR**  
HANDLESS | POIGNÉE

NORMA LARGO | CORTO

COMPLET



BASIC



## NORMA 204

L359,6 H250 F60,5

NOGAL AMERICANO

INTERIOR INSIDE | INTÉRIEUR BEIGE

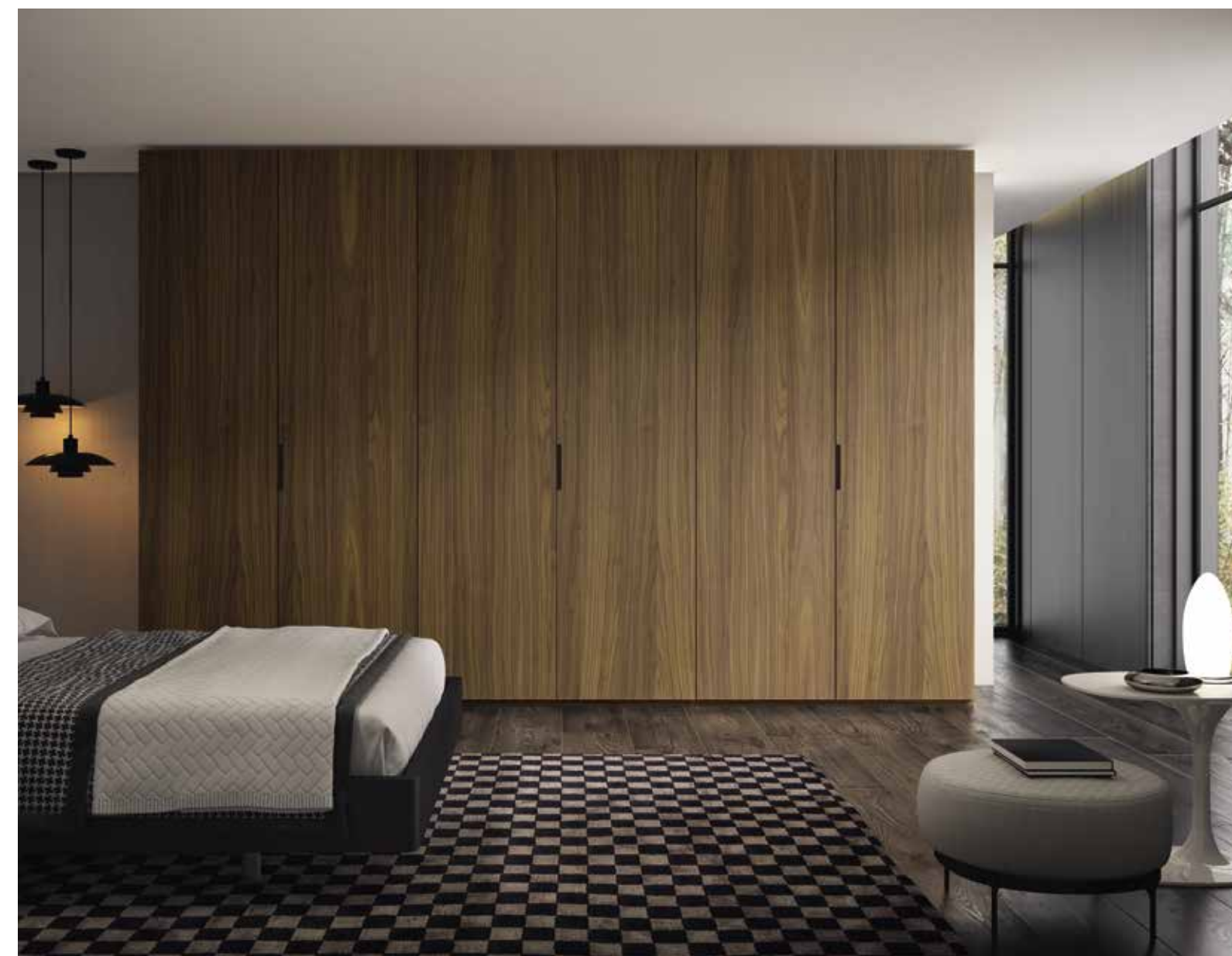

### NORMA 204

L359,6 H250 F60,5

**APERTURA**  
SWING | OUVERTURE

BATIENTE

**PUERTAS**  
DOORS | PORTES

NORMA | LISA

**TIRADOR**  
HANDLESS | POIGNÉE

NORMA CORTO

BASIC



NORMA

Puertas lisas con tirador empotrado NORMA metálico. Puedes elegir la combinación que más te guste de tirador: asimétrico largo y corto o solo corto. El acabado de este tirador es en color Marrón Metal o lacado en cualquiera de nuestros acabados.

Smooth doors with NORMA metal recessed handle. You can choose the combination that you like the most of the shooter: asymmetric long and short or only short. The finish of this handle is in a Marrón Metal color or lacquered in any of our finishes.

Portes lisses avec poignée NORMA métallique encastrée. Vous pouvez choisir la combinaison de la poignée qui vous plaît le plus: Asymétrique large et courte, ou seulement courte. La finition de cette poignée est en couleur Marrón Metal ou laqué en nos finitions, quelles qu'elles soient.



# SCULTOR 205

L359,6 H240 F60,5

SALVIA

INTERIOR INSIDE | INTÉRIEUR OREGÓN

MUEBLES  
GRUPO  
**INTERMOBEL**





## SCULTOR 205

SALVIA

INTERIOR INSIDE | INTÉRIEUR OREGÓN



MUEBLES  
GRUPO  
**INTERMOBEL**

## SCULTOR | LYRA 206

L239,2 H240 F60,5

PERLA | MARCO SOMBRA

INTERIOR INSIDE | INTÉRIEUR OREGÓN



### SCULTOR 205

L359,6 H240 F60,5

**APERTURA**  
SWING | OUVERTURE

BATIENTE

**PUERTAS**  
DOORS | PORTES

SCULTOR

**TIRADOR**  
HANDLESS | POIGNÉE

ONA

COMPLET



BASIC



### SCULTOR LYRA 206

L239,2 H240 F60,5

**APERTURA**  
SWING | OUVERTURE

BATIENTE

**PUERTAS**  
DOORS | PORTES

SCULTOR | LYRA

**TIRADOR**  
HANDLESS | POIGNÉE

ONA

COMPLET



BASIC



#### SCULTOR | LYRA

Puertas SCULTOR lacada en color Perla con tirador metálico ONA lacado del mismo color. En esta propuesta se combina con puertas centrales LYRA con marco de aluminio Sombra y cristal Parsol.

SCULTOR doors lacquered in Perla color with ONA metal handle lacquered in the same color. In this proposal it is combined with LYRA central doors with Sombra aluminum frame and Parsol glass.

Portes SCULTOR laquées en couleur Perla avec poignée métallique ONA laquée de la même couleur. Cette proposition se combine avec des portes centrales LYRA avec un cadre en aluminium Sombra et verre Parsol.



## VEGA 207

L240 H240 F60,5

ALMENDRA | MARCO TÓRTORA

INTERIOR INSIDE | INTÉRIEUR OREGÓN



## CARINA 208

L299,9 H240 F60,5

NOGAL AMERICANO | MARCO SOMBRA

INTERIOR INSIDE | INTÉRIEUR BEIGE

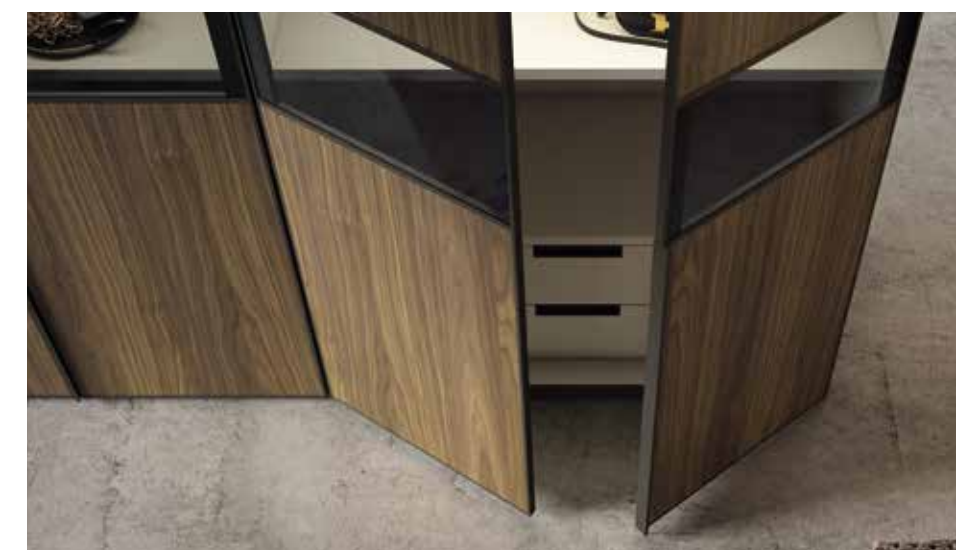

GRUPO  
MUEBLES  
**INTERMOBEL**

### VEGA 207

L240 H240 F60,5

APERTURA  
SWING | OUVERTURE

BATIENTE

PUERTAS  
DOORS | PORTES

VEGA

TIRADOR  
HANDLESS | POIGNÉE

RECTO

COMPLET



BASIC



VEGA | CARINA  
Puertas enmarcadas con marco de aluminio, en color a elegir, con tablero interior en acabado lacado o chapa natural.

Framed doors with an aluminum frame, in a color to choose, with an interior panel in a lacquered or natural veneer finish.

Portes encadrées par un cadre d'aluminium, couleur à choisir, avec un tableau intérieur fini laqué ou placage naturel

### CARINA 208

L299,9 H240 F60,5

APERTURA  
SWING | OUVERTURE

BATIENTE

PUERTAS  
DOORS | PORTES

CARINA

TIRADOR  
HANDLESS | POIGNÉE

RECTO

COMPLET



BASIC











**VEGA**

Armario de puertas batientes VEGA con marco de aluminio en acabado Sombra y paneles en acabado laca Perla. Propuesta de gran capacidad que complementada con el módulo ISLA ofrece todas las ventajas de un gran vestidor con puertas.

VEGA swinging doors with aluminum frame in Sombra finish and panels in Perla lacquer finish. Large capacity proposal that complemented with the ISLA module offers all the advantages of a large walk-in closet with doors.

Armoire à portes battantes VEGA avec un cadre d'aluminium fini Sombra et panneaux finis laqués Perla. Proposition de grande capacité qui, en complément du module ISLA, offre tous les avantages d'un grand dressing avec portes.

**VEGA 209**

L359,6 H240 F60,5

**APERTURA**  
SWING | OUVERTURE

BATIENTE

**PUERTAS**  
DOORS | PORTES

VEGA

**TIRADOR**  
HANDLESS | POIGNÉE

RECTO

**COMPLET**



**BASIC**





# BODE 210

L240 H240 F60,5

SEPIA | NOGAL AMERICANO

INTERIOR INSIDE | INTÉRIEUR BEIGE

GRUPPO  
MUEBLES  
**INTERMOBEL**







**BODE**  
 Armario de puertas batientes BODE en acabado laca Sepia con uñero y detalle en chapa natural de Nogal Americano. Interior Beige con cajones de 3 y 5 cajones LINE.

BODE swinging doors in Sepia lacquer finish with fingernail and detail in natural Nogal Americano veneer. Beige interior with drawers of 3 and 5 drawers LINE.

Armoire à portes battantes BODE fini laqué Sepia avec poignée cuvette et détail en placage naturel de Bois de Nogal Americano. Intérieur Beige avec tiroirs de 3 et 5 tiroirs LINE.

**BODE 210**

L240 H240 F60,5

**APERTURA**  
 SWING | OUVERTURE

BATIENTE

**PUERTAS**  
 DOORS | PORTES

BODE

COMPLET



BASIC





**DRACO 211**

L480 H240 F60,5

BLANCO

INTERIOR INSIDE | INTÉRIEUR OREGÓN | ESTAMPADO DORADO

GRUP  
INTERMOBEL







**\* Detalle armario sin puertas**

Wardrobe detail without doors | Détail de l'armoire sans portes

**DRACO**

Las puertas DRACO destacan por el plano inclinado de su frente combinado con el tirador metálico en acabado Cromo o Aluminio mate. Los frentes están acabados en laca mate Blanco. Interior Oregón y trasera estampada Dorada.

The DRACO doors stand out for the inclined plane of their front combined with the metallic handle in Cromo or Aluminio mate finish. The fronts are finished in Blanco lacado mate. Interior Oregón and Dorada patterned back.

Les portes DRACO ressortent pour le plan incliné de sa façade combiné avec la poignée métallique finie Cromo et Aluminio mate. Les façades sont finies en Blanco lacado mate. Intérieur Oregón et arrière estampée Dorada.



**DRACO 211**

L480 H240 F60,5

**APERTURA**  
SWING | OUVERTURE

BATIENTE

**PUERTAS**  
DOORS | PORTES

DRACO

**COMPLET**



**BASIC**





LEO 212

L299,9 H240 F60,5

SOMBRA

INTERIOR INSIDE | INTÉRIEUR BEIGE

MUGGIUS  
**INTERMOBEL**







**LEO**  
 Armario batiente LEO con puertas lacadas Sombra con interior Beige y cajones Élite. La propuesta se acompaña con la cómoda CUBO en Sombra y Nogal Americano.

LEO hinged wardrobe with Sombra lacquered doors with Beige interior and Elite drawers. The proposal is accompanied by the CUBO dresser in Sombra and Nogal Americano.

Armoire battant LEO avec portes laquées Sombra avec intérieur Beige et tiroirs Élite. La proposition s'accompagne avec la commode CUBO en Sombra et Bois de Nogal Americano.



**LEO 212**

L299,9 H240 F60,5

**APERTURA**  
 SWING | OUVERTURE

BATIENTE

**PUERTAS**  
 DOORS | PORTES

LEO

COMPLET



BASIC





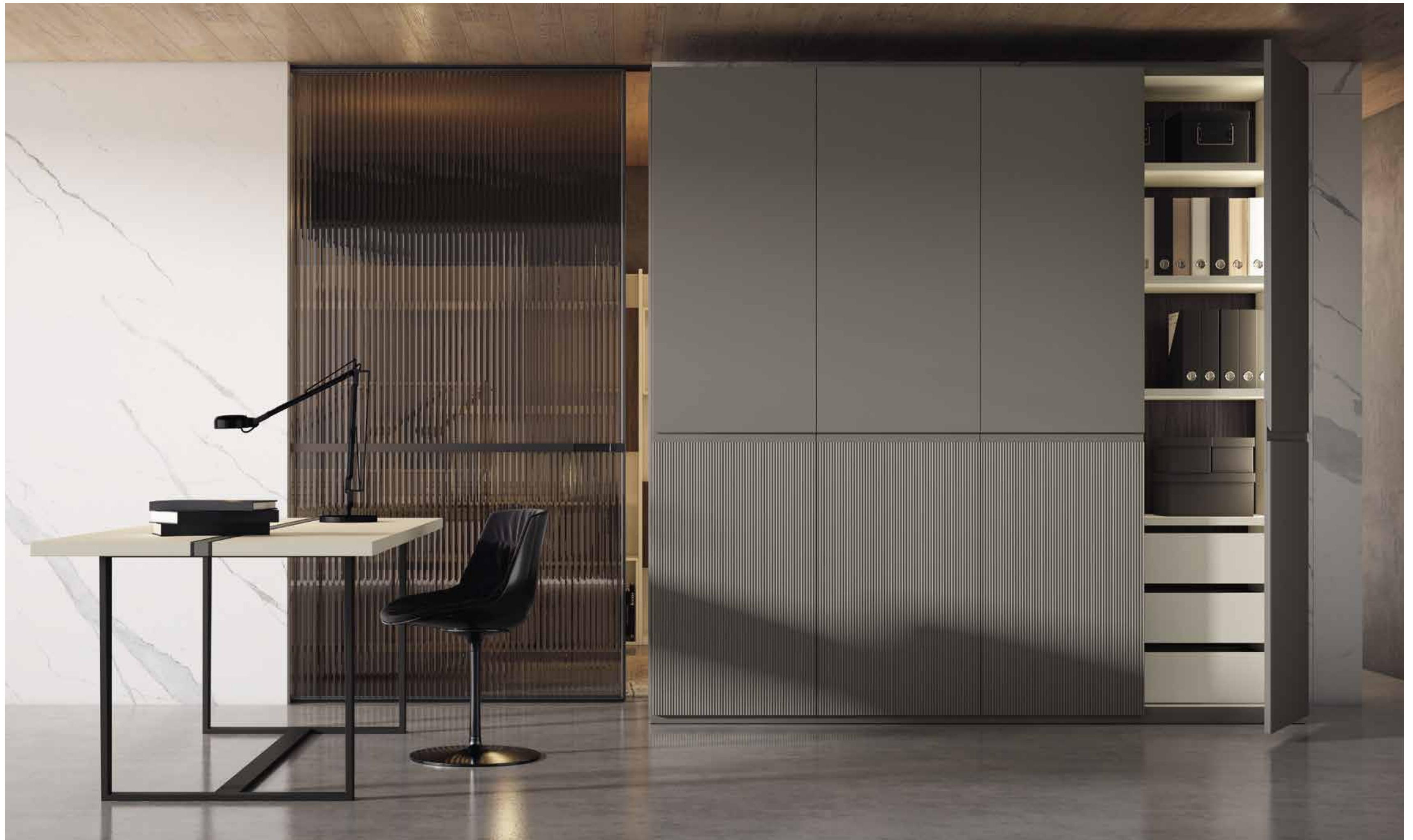





**\* Detalle armario sin puertas**  
Wardrobe detail without doors | Détail de l'armoire sans portes



**ARA**  
Armario batiente con puertas ARA en acabado laca mate Tiza que destaca el panel inferior W. Interior Beige con trasera Oregón y cajones Line.

Hinged wardrobe with ARA doors in a Tiza matt lacquer finish that highlights the lower panel W. Beige interior with Oregón back and Line drawers.

Armoire battant avec portes ARA fini laqué mat Tiza qui ressort le panneau inférieur W. Intérieur Beige avec arrière Oregón et tiroirs Line.

**ARA 213**

L240 H240 F60,5

**APERTURA**  
SWING | OUVERTURE

BATIENTE

**PUERTAS**  
DOORS | PORTES

ARA

COMPLET



BASIC











#### VITREO

Armario batiente VITREO con puertas de cristal con armazón de aluminio anodizado Black. Sistema de apertura con bisagra "invisible". Interior Oregón y trasera estampada Dorada y luz led en los estantes.

VITREO hinged wardrobe with glass doors with Black anodized aluminum frame. Opening system with an "invisible" hinge. Oregón interior and Dorada patterned back and led light on the shelves.

Armoire battant VITREO avec portes en verre avec armature d'aluminium anodisé Black. Système d'ouverture avec charnière "invisible". Intérieur Oregón et arrière estampée Dorada et lumière led dans les étagères.

#### VITREO 214

L359,2 H240 F60,5

APERTURA  
SWING | OUVERTURE

BATIENTE

PUERTAS  
DOORS | PORTES

VITREO

COMPLET



BASIC





# DINAMIC

ARMARIOS SINGULARES

UNIQUE WARDROBES  
ARMOIRES UNIQUES



# SINGULAR 300

L240 H240 F60,5

TIZA

INTERIOR INSIDE | INTÉRIEUR BEIGE | ESTAMPADO FLORAL



MUEBLES  
**INTERMOBEL**



## SINGULAR 300

L240 H240 F60,5

**APERTURA**  
SWING | OUVERTURE

PLEGABLE

**PUERTAS**  
DOORS | PORTES

PLEGABLE

**TIRADOR**  
HANDLESS | POIGNÉE

NORMA CORTO





**PLEGABLE Y MÁS...**

Solución de armario de puertas plegables combinado con cajones vistos. Si buscas una distribución diferente, busca en nuestro programa, la medida que mejor se adapte a tu espacio.

**FOLDING AND MORE ...**

Folding door wardrobe solution combined with exposed drawers. If you are looking for a different layout, look in our program for the measure that best suits your space.

**PLIABLE ET PLUS...**

Solution d'armoire de portes pliables combiné avec des tiroirs visibles. Si vous cherchez une distribution différente, trouvez dans notre programme la mesure qui s'adapte le mieux à votre espace.

**SINGULAR 301**

L358,4 H240 F60,5

**APERTURA**  
SWING | OUVERTURE

PLEGABLE

**PUERTAS**  
DOORS | PORTES

PLEGABLE | PUSH

**TIRADOR**  
HANDLESS | POIGNÉE

NORMA CORTO







## SINGULAR 302

L599,7 H240 F60,5

**APERTURA**  
SWING | OUVERTURE

BATIENTE

**PUERTAS**  
DOORS | PORTES

NORMA CORTO | PUSH

### MÓDULO BAUL

Buscamos soluciones prácticas para tu programa de armarios. Un funcional baúl con tapa elevable para que puedas guardar todas tus cosas.

### MESA ESCRITORIO NORMA

Pensamos en el amueblamiento de espacios multifuncionales, si necesitas poner un pequeño despacho o escritorio, esta es una de las soluciones que te ofrecemos. Con un cómodo pasacables, sus cajones y un hueco para que organices todas tus cosas.

### TRUNK MODULE

We look for practical solutions for your wardrobe program. A functional trunk with a lifting lid so you can store all your things.

### NORMA DESK TABLE

We think about the furnishing of multifunctional spaces, if you need to put a small office or desk, this is one of the solutions we offer you. With a comfortable cable guide, its drawers and a hole for you to organize all your things.

### MODULE BAUL

Nous cherchons des solutions pratiques pour votre programme d'armoires. Un coffre fonctionnel avec une porte élevable pour que vous puissiez garder tous vos objets.

### TABLE DE BUREAU NORMA

Nous pensons à l'aménagement des espaces multifonctions, si vous avez besoin de mettre un petit bureau ou pupitre, celle-ci est une des solutions que nous vous offrons. Avec un passe-câbles pratique, ses tiroirs et son creux pour que vous organisiez tous vos objets.





## SINGULAR 303

L420 H240 F60,5

APERTURA  
SWING | OUVERTURE

BATIENTE

PUERTAS  
DOORS | PORTES

HALF | LISA | PUSH

### TAMA TV

El módulo TAMA TV consiste en un expositor construido con un panel lacado o en acabado chapa natural preparado con todo el sistema eléctrico para conectar la TV y el sistema Wifi sin problemas. Se ofrece en varias medidas en función del armario que lo acompañe. Frentes Push acabado lacado mate Tiza y tirador Half en chapa natural Nogal Americano.

The TAMA TV module consists of an exhibitor built with a lacquered panel or in a natural veneer finish prepared with the entire electrical system to connect the TV and the Wi-Fi system without problems. It is offered in various sizes depending on the wardrobe that accompanies it. Push fronts in Tiza in matt lacquered finish and Half handle in natural Nogal Americano veneer.

Le module TAMA TV consiste en un présentoir construit avec un panneau laqué ou terminé en placage naturel préparé avec tout le système électrique pour connecter la TV et le système Wifi sans problème. Il vous est offert dans plusieurs mesures en fonction de l'armoire qui l'accompagne. Portes Push terminées laquées mat Tiza et poignée Half en placage naturel Bois de Nogal Americano.

muebles  
INTERMOBEL



# SINGULAR 304

L360 H240 F60,5

BLANCO

INTERIOR INSIDE | INTÉRIEUR BEIGE



## SINGULAR 304

L360 H240 F60,5

**APERTURA**  
SWING | OUVERTURE

BATIENTE

**PUERTAS**  
DOORS | PORTES

NORMA CORTO | LISA | PUSH

**AMUEBLAMOS GRANDES ESPACIOS**  
Armario batiente con terminal TAMA y módulos abiertos. Puertas con sistema Push sin tirador y luz led integrada.

**WE FURNISH LARGE SPACES**  
Swing cabinet with TAMA terminal and open modules. Doors with Push system without handles and integrated led light.

**NOUS AMEUBLONS DES GRANDS ESPACES**  
Armoire battant avec terminal TAMA et modules ouverts. Portes avec système Push sans poignée et lumière led intégrée.



## SINGULAR 305

L300 H240 F60,5

ALMENDRA | TÓRTORA

INTERIOR INSIDE | INTÉRIEUR BEIGE



### SINGULAR 305

L300 H240 F60,5

**APERTURA**  
SWING | OUVERTURE

BATIENTE

**PUERTAS**  
DOORS | PORTES

NORMA CORTO | PUSH

#### CÓMODA INTEGRADA EN TU ARMARIO

Módulo de cajones integrada entre dos armarios. Grandes contenedores para almacenar todo lo que necesites. La parte superior se remata con panel trasero con lacado Tórtora y toma de enchufes por si quieres poner tu TV o lo que necesites.

#### DRESSER INTEGRATED IN YOUR WARDROBE

Drawer module integrated between two cabinets. Large containers to store everything you need. The upper part is finished with a back panel with Tórtora lacquer and plug socket in case you want to put your TV or whatever you need.

#### COMMUNE INTÉGRÉE DANS VOTRE ARMOIRE

Module de tiroirs intégré entre deux armoires. Grands conteneurs pour stocker tout ce dont vous avez besoin. La partie supérieure se termine avec un panneau arrière laqué Tórtora et une prise pour si vous voulez y mettre une TV ou ce dont vous avez besoin.

## SINGULAR 306

L180 H240 F60,5

SOMBRA | MARCO SOMBRA

INTERIOR OREGÓN

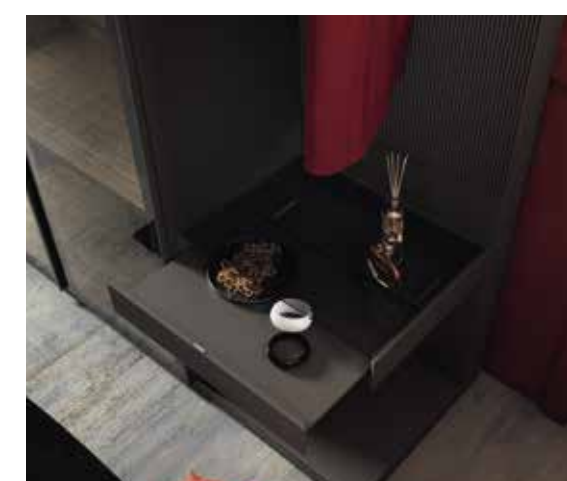

### SINGULAR 306

L180 H240 F60,5

**APERTURA**  
SWING | OUVERTURE

BATIENTE

**PUERTAS**  
DOORS | PORTES

LYRA | PUSH

**TIRADOR**  
HANDLESS | POIGNÉE

RECTO

#### VESTÍBULO O RECIBIDOR

Atractiva combinación de armario con puertas de cristal y complemento para colgar abierto, con bandeja extraíble de cristal y luz led integrada pensada para tu recibidor o entrada de la casa.

#### LOBBY OR RECEIVER

Attractive combination of wardrobe with glass doors and an open hanging accessory, with removable glass tray and integrated led light designed for your hall or entrance to the house

#### VESTIBULE OU HALL D'ENTRÉE

Combinaison attrayante d'armoire avec portes en verre et complément ouvert pour pendre, avec bac extractible en verre et lumière led intégrée pensée pour votre hall d'entrée ou vestibule de votre maison.





**MULTIFUNCIONAL**

Este es el concepto básico de un armario de rincón con puertas batientes. Una solución ligera y de la máxima funcionalidad. Si además, es atractiva y moderna, mucho mejor. ¿No crees?. Acabado laca mate Almendra, interior Beige.

**MULTIFUNCIONAL**

This is the basic concept of a corner cabinet with hinged doors. A lightweight solution with maximum functionality. If it is also attractive and modern, much better. Don't you think? Almendra matt lacquer finish, Beige interior.

**MULTIFONCTIONNEL**

Ceci est le concept basic d'un armoire de coin avec portes battantes. Une solution légère et d'une fonctionnalité maximum. Si en plus, elle est attrayante et moderne, cela est beaucoup mieux. Vous ne croyez pas? Fini laqué mat Almendra, intérieur Beige.

**SINGULAR 307**

L237,1+297,4 H240 F60,5

**APERTURA**  
SWING | OUVERTURE

BATIENTE

**PUERTAS**  
DOORS | PORTES

SCULTOR | LISA

**TIRADOR**  
HANDLESS | POIGNÉE

ONA

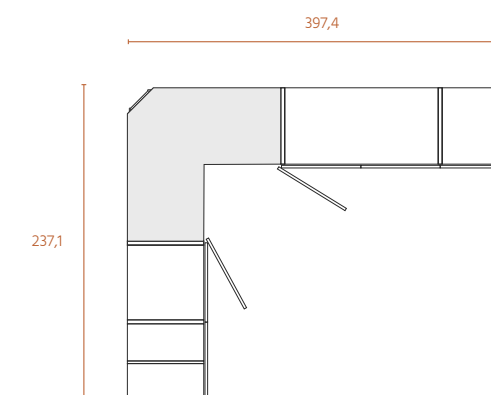





## SINGULAR 308

L223,4+237,4 H240 F60,5

**APERTURA**  
SWING | OUVERTURE

BATIENTE | PLEGABLE

**PUERTAS**  
DOORS | PORTES

NORMA | LISA

**TIRADOR**  
HANDLESS | POIGNÉE

NORMA CORTO

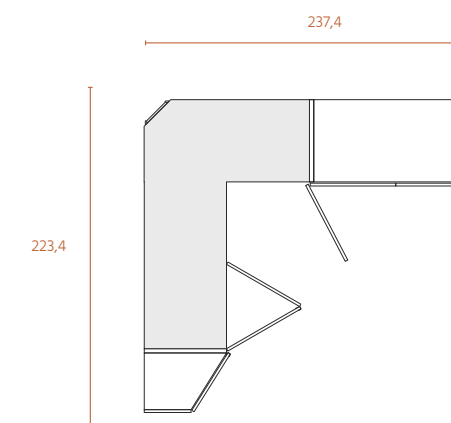

**RINCÓN CON PUERTAS PLEGABLES**  
Armario de rincón con puertas plegables. Gran amplitud visual y acceso más práctico. Se complementa con un armario chaflán. Puertas en laca mate Salvia y tirador Norma e interior en acabado Oregón.

**CORNER WITH FOLDING DOORS**  
Corner wardrobe with folding doors. Great visual breadth and more practical access. It is complemented by a chamfer cabinet. Salvia matt lacquered doors and Norma handle and Oregón finish interior.

**COIN AVEC PORTES PLIABLES**  
Armoire en coin avec portes pliantes. Grande amplitude visuelle et accès plus pratique. Il se complémente avec un armoire chanfrein. Portes laquées mat Salvia et poignée Norma et intérieur fini Oregón.



# SINGULAR 309

L359,6 H240 F60,5

TIZA

INTERIOR INSIDE | INTÉRIEUR OREGÓN



DINAMIC



GRUPO  
MUEBLES  
**INTERMOBEL**

## SINGULAR 309

L359,6 H240 F60,5

**APERTURA**  
SWING | OUVERTURE

PLEGABLE

**PUERTAS**  
DOORS | PORTES

PLEGABLE

**TIRADOR**  
HANDLESS | POIGNÉE

NORMA CORTO





# MOVIE

## CORREDERAS

SLIDING DOORS  
PORTES COULISSANTES

INTERMOBEL









**DELTA**

Armario de puertas correderas DELTA acabado laca mate Tiza con tirador Sepia. Cuerpo central con pantalonero extraíble y estantes interiores en color Beige.

DELTA sliding door wardrobe with matte Tiza lacquer finish with Sepia handle. Central body with removable trouser rack and interior shelves in Beige.

Armoire à portes coulissantes DELTA fini laqué mat Tiza avec poignée Sépia. Corps central avec "pantalonnier" extractible et étagères intérieures couleurs Beige.

**DELTA 400**

L299,9 H240 F66

**APERTURA**  
SWING | OUVERTURE

CORREDERA

**PUERTAS**  
DOORS | PORTES

DELTA

COMPLET



BASIC











GRUPO muebles **INTERMOBEL**



**TANIA 401**

L240 H240 F66

**APERTURA**  
SWING | OUVERTURE

CORREDERA

**PUERTAS**  
DOORS | PORTES

TANIA

COMPLET



BASIC



**TANIA**

Armario de puertas correderas TANIA con pieza central panel W lacado color Almendra. Tirador metálico integrado en el lateral de la puerta.

TANIA sliding door wardrobe with Almendra color lacquered W panel centerpiece. Integrated metal handle on the side of the door.

Armoire à portes coulissantes TANIA avec en pièce centrale un panneau W laqué couleur Almendra. Poignée métallique intégrée dans le latéral de la porte.









**PIXEL 402**

L359,9 H240 F66

**APERTURA**  
SWING | OUVERTURE

CORREDERA

**PUERTAS**  
DOORS | PORTES

PIXEL

COMPLET



BASIC





**DRACO C 403**

L400 H240 F66

SEPIA | NEGRUZCO

INTERIOR INSIDE | INTÉRIEUR BEIGE

GRUPPO  
**INTERMOBEL**







muebles  
**INTERMOBEL**

**DRACO CORREDERA**

Armario de puertas correderas DRACO, propuesta moderna y atrevida para un frente de gran personalidad. Acabado lacado mate Sepia con tirador Negruzco. Interior Beige con cajones Line.

DRACO sliding door wardrobe, a modern and daring proposal for a front with great personality. Sepia matt lacquered finish with Negruzco handle. Beige interior with Line drawers.

Armoire à portes coulissantes DRACO, proposition moderne et osée pour une façade de grande personnalité. Fini laqué mat Sepia avec poignée Negruzco. Intérieur Beige avec tiroirs Line.

**DRACO C 403**

L400 H240 F66

**APERTURA**  
SWING | OUVERTURE

CORREDERA

**PUERTAS**  
DOORS | PORTES

DRACO C

COMPLET



BASIC





**DOBLE 404**

L299,9 H240 F66

MARCO SOMBRA | CRISTAL PARSOL

INTERIOR INSIDE | INTÉRIEUR OREGÓN

muebles  
**INTERMOBEL**





## DOBLE 404

MARCO SOMBRA | CRISTAL PARSOL

INTERIOR INSIDE | INTÉRIEUR OREGÓN



GRUPO  
**INTERMOBEL**

## DOBLE 405

L299,9 H240 F66

TEJA | MARCO SOMBRA

INTERIOR INSIDE | INTÉRIEUR BEIGE



### DOBLE 404

L299,9 H240 F66

**APERTURA**  
SWING | OUVERTURE

CORREDERA

**PUERTAS**  
DOORS | PORTES

DOBLE CRISTAL PARSOL

COMPLET



BASIC



### DOBLE 405

L299,9 H240 F66

**APERTURA**  
SWING | OUVERTURE

CORREDERA

**PUERTAS**  
DOORS | PORTES

DOBLE LACADO

COMPLET



BASIC







**DOBLE**

Armario de puertas correderas DOBLE, práctico armario con cuerpo central expositor y puertas laterales correderas. Las puertas Dobles se construyen con perfil de aluminio que puede lacarse del mismo color que los plafones interiores, en este caso lacado Perla.

DOUBLE sliding door cabinet, practical cabinet with central display unit and sliding side doors. Double doors are built with an aluminum profile that can be lacquered in the same color as the interior panels, in this case Perla lacquered.

Armoire à portes coulissantes DOBLE, pratique armoire avec un présentoir en corps central et portes latérales coulissantes. Les portes Double se construisent avec un profil d'aluminium que vous pouvez laqué de la même couleur que les plafonds inférieurs, dans ce cas-ci Perla.

**DOBLE 406**

L360 H240 F66

**APERTURA**  
SWING | OUVERTURE

CORREDERA

**PUERTAS**  
DOORS | PORTES

DOBLE LACADO

COMPLET



BASIC







**CORREDERAS PUERTAS INTERIORES**  
 Armario de puertas correderas interiores con frente TANIA acabado lacado mate Mostaza. Interior Beige con cajones Line.

**SLIDING INTERIOR DOORS**  
 Interior sliding door wardrobe with TANIA front, Mostaza matt lacquered finish. Beige interior with Line drawers.

**PORTES INTÉRIEURES COULISSANTES**  
 Armoire à portes coulissantes intérieures avec le front TANIA fini laqué mat Mostaza. Intérieur Beige avec tiroirs Line.

**TS 407**

L300 H240 F68

**APERTURA**  
 SWING | OUVERTURE

**CORREDERA**

**PUERTAS**  
 DOORS | PORTES

TANIA

COMPLET



BASIC





TS 408

L240 H240 F68

SEPIA | NOGAL AMERICANO

INTERIOR INSIDE | INTÉRIEUR BEIGE

MUEBLES  
**INTERMOBEL**







**TS DELTA**  
 Armario de puertas correderas interiores con frente DELTA acabado lacado mate Sepia y tirador en Nogal Americano. Molduras perimetrales lacadas en color Sepia e interior Beige con cajones Line.

Interior sliding door wardrobe with DELTA front, Sepia matt lacquered finish and Nogal Americano handle. Sepia lacquered perimeter moldings and Beige interior with Line drawers.

Armoire à portes coulissantes intérieures avec le front DELTA fini laqué mat Sepia et poignée en Bois de Nogal Americano. Moulures périphériques laquées couleur Sepia et intérieur Beige avec tiroirs Line.

**TS 408**

L240 H240 F68

**APERTURA**  
 SWING | OUVERTURE

**CORREDERA**

**PUERTAS**  
 DOORS | PORTES

**DELTA**

COMPLET



BASIC





# COMPLEMENTOS

INTERIORES ARMARIOS  
TIPOS PUERTAS  
ACABADOS

WARDROBE INTERIORS  
DOORS TYPES  
FINISHES

INTÉRIEURS D'ARMOIRES  
TYPES DE PORTES  
FINITIONS

INTERMOBEL



**DISEÑO INTERIOR**

INTERIOR DESIGN | DESIGN INTÉRIEUR

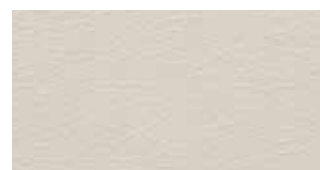

BEIGE



OREGÓN

Interiores disponibles en dos colores a elegir BEIGE y OREGÓN.

Interiors available in two colors to choose from BEIGE and Oregon.

Intérieurs disponibles en deux coloris au choix BEIGE et Oregón.



BEIGE



OREGÓN

**ACABADOS TRASERAS**

REAR FINISHES | FINITIONS ARRIÈRE



BEIGE



OREGÓN



FLORAL

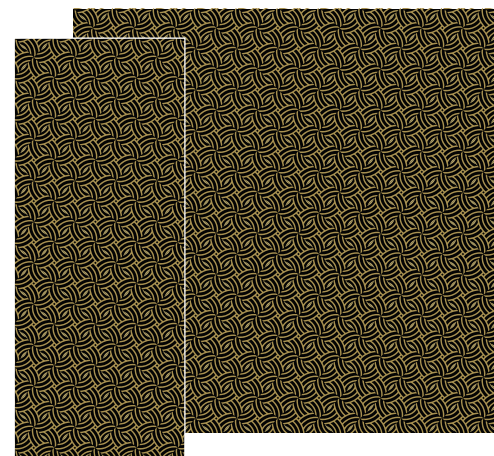

DORADA

**FRENTES INTERIORES**

INTERIOR FRONTS | INTÉRIEUR AVANT

**CAJÓN LINE**

Los frentes de cajón llevan sistema de apertura hueco sin tirador.

The drawer fronts have a handleless hollow opening system.

Les façades des tiroirs ont un système d'ouverture creuse sans poignée.



**CAJÓN ÉLITE**

Los frentes de cajón llevan tirador metálico empotrado en acabado color Sombra.

The drawer fronts have a recessed metal handle in a Sombra color finish.

Les façades des tiroirs ont une poignée en métal encastrée dans une finition de Sombra



**CAJÓN CRISTAL**

Frentes de cajón enmarcados con aluminio y cristal PARSOL con tirador metálico.

Drawer fronts framed with PARSOL aluminum and glass with metal handle.

Façades de tiroirs d'aluminium PARSOL et moulure de verre avec poignée en métal.



**ACABADO INTERIOR**  
INTERIOR FINISHING  
FINITIONS INTÉRIEURES



ANTRACITA

**ILUMINACIÓN**

LIGHTING | ÉCLAIRAGE

**LATERAL CON LED**

SIDE WITH LED | CÔTÉ AVEC LED

Tira de luz led en laterales y particiones de armarios con sensor o interruptor.

Led light strip on sides and partitions of cabinets with sensor or switch.

Bande lumineuse led sur les côtés et cloisons des armoires avec capteur ou interrupteur.

**ESTANTE CON LED**

SHELF WITH LED

ÉTAGÈRE AVEC LED

Tira de luz led en estantes interiores con sensor o interruptor.

Led strip light on interior shelves with sensor or switch.

Bande lumineuse led sur étagères intérieures avec capteur ou interrupteur.



**COMPLEMENTOS**

ACCESSORIES | ACCESSOIRES

**REBAJE PARA ZÓCALO**

REDUCTION FOR PLINTH | RÉDUCTION POUR SOCLE

Puedes pedir lados con más fondo para rebaje rodapié.

You can order sides with more depth for skirting recess.

Vous pouvez commander des côtés avec plus de profondeur pour l'évidente de la plinthe.

**TAPETAS Y REMATES**

RECESSED COVERS | BOUCHONS ET FINITIONS

Juego de tapetas y molduras para empotrar armarios.

Set of covers and moldings to embed cabinets.

Ensemble de couvercles et moulures pour encastrer les armoires.





## ACCESORIOS INTERIORES

INTERIOR FINISHES | FINITIONS INTÉRIEURES

### ACABADOS INTERIORES INTERIOR FINISHES FINITIONS INTÉRIEURES

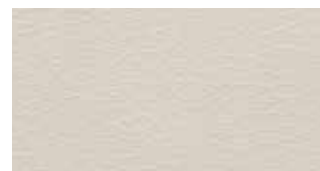

BEIGE



OREGÓN

- 1. CONTENEDOR**  
CONTAINER | CONTENEUR
- 2. BANDEJA EXTRAÍBLE**  
REMOVABLE TRAY | PLATEAU AMOVIBLE
- 3. COMPLEMENTO CUADRÍCULA**  
GRID COMPLEMENT | COMPLÉMENT D'ORGANISATION
- 4. ZAPATERO FIJO**  
FIXED SHOES SPACE | ÉTAGÈRE À CHAUSSURES FIXE
- 5. ESTANTES INTERIORES**  
INTERIOR SHELVES | ÉTAGÈRES INTÉRIEURES
- 6. BUCH PANTALONERO EXTRAÍBLE**  
TROUSERS AMOVIBLE | PORTE-PANTALONS AMOVIBLE



1



2



3



4



5



6

## ACCESORIOS ESPRESSO

ESPRESSO ACCESSORIES | ACCESSOIRES EXPRESSO

- 1. PANTALONERO EXTRAÍBLE**  
TROUSERS PULL-OUT  
PORTE-PANTALONS AMOVIBLE
- 2. COLGADOR EXTRAÍBLE**  
REMOVABLE HANGER  
PORTE-VÊTEMENTS
- 3. BARRA COLGAR RINCÓN**  
BAR HANGING CORNER  
BARRE SUSPENDUE EN COIN
- 4. COLGADOR ABATIBLE**  
PULL-DOWN BAR TO HANGERS  
PORTE-VÊTEMENTS RATTABLE
- 5. ZAPATERO LATERAL EXTRAÍBLE**  
REMOVABLE LATERAL SHOES SPACE  
ÉTAGÈRE À CHAUSSURES LATÉRALE
- 6. ZAPATERO EXTRAÍBLE**  
REMOVABLE SHOES SPACE  
ÉTAGÈRE À CHAUSSURES AMOVIBLE
- 7. BARRA COLGAR A ESTANTE**  
BAR HANGING ON SHELF  
BAR ACCROCHÉ SUR ÉTAGÈRE
- 8. BARRA COLGAR**  
HANGING BAR  
BARRE DE SUSPENSION



1



2

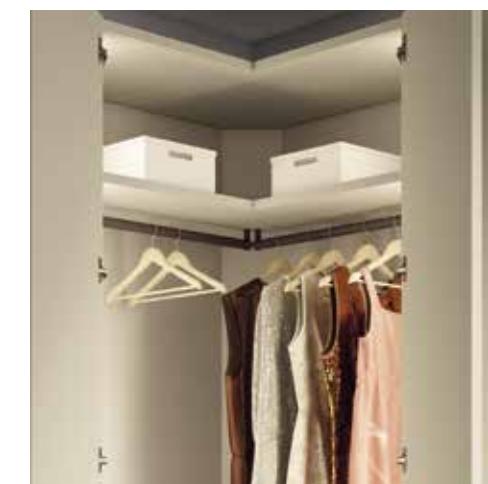

3

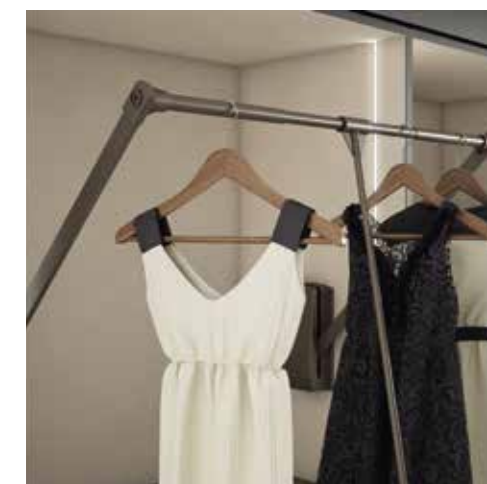

4



5



6



7



8

MUEBLES  
**INTERMOBEL**

### ACABADO METAL METAL FINISHES FINITION EN MÉTAL

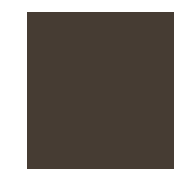

ESPRESSO

Todos nuestros herrajes cumplen las más estrictas normas europeas y gozan de la máxima calidad de fabricación.

All our fittings comply with the strictest European regulations and are of the best manufacturing quality.

Toutes nos ferrures sont conformes aux normes européennes les plus strictes et bénéficient de la plus haute qualité de fabrication.



# TIPOS DE PUERTA

DOOR TYPES | TYPES DE PORTES

## PUERTAS BATIENTES

SWING DOORS | PORTES BATTANTES



### HALF

CHAPA  
VENEER | BOIS  
LACA MATE  
MAT LACQUERED | LAQUE MATE

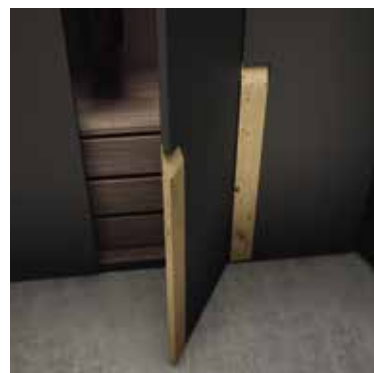

### TRAMA

CHAPA  
VENEER | BOIS  
LACA MATE  
MAT LACQUERED | LAQUE MATE



### NORMA

CHAPA  
VENEER | BOIS  
LACA MATE  
MAT LACQUERED | LAQUE MATE  
TIRADOR MARRÓN METAL O LACADO  
MARRÓN METAL OR LACQUERED HANDLE  
POIGNÉE MARRÓN METAL OU LAQUÉ



### SCULTOR

LACA MATE  
MAT LACQUERED | LAQUE MATE  
TIRADOR ONA MARRÓN METAL O LACADO  
ONA MARRÓN METAL OR LACQUERED HANDLE  
POIGNÉE ONA MARRÓN METAL OU LAQUÉE



### VEGA

MARCO ALUMINIO LACADO  
LACQUERED ALUMINUM FRAME  
CADRE EN LAQUÉ ALUMINIUM  
CHAPA  
VENEER | BOIS  
LACA MATE  
MAT LACQUERED | LAQUE MATE



### CARINA

MARCO ALUMINIO LACADO  
LACQUERED ALUMINUM FRAME  
CADRE EN LAQUÉ ALUMINIUM  
LACA MATE | CRISTAL  
MAT LACQUERED-GLASS | LAQUE MATE-VERRE  
CHAPA | CRISTAL  
VENEER - GLASS | BOIS - VERRE



### LYRA

MARCO ALUMINIO LACADO  
LACQUERED ALUMINUM FRAME  
CADRE EN LAQUÉ ALUMINIUM  
CRISTAL  
GLASS | VERRE  
TIRADOR RECTO O ONA  
RECTO OR ONA HANDLE  
POIGNÉE RECTO OU ONA



### BODE

LACA MATE  
MAT LACQUERED | LAQUE MATE  
CHAPA  
VENEER | BOIS  
TIRADOR CHAPA O LACA MATE  
SHEET HANDLE OR MATT LACQUER  
POIGNÉE EN BOIS OU LAQUE MAT



### ARA

LACA MATE  
MAT LACQUERED | LAQUE MATE  
CHAPA / LACA MATE  
VENEER / MAT LACQUERED  
BOIS / LAQUE MATE



### LEO

LACA MATE  
MAT LACQUERED | LAQUE MATE  
CHAPA  
VENEER | BOIS



### DRACO

LACA MATE  
MAT LACQUERED | LAQUE MATE  
CHAPA  
VENEER | BOIS  
TIRADOR CROMO O ALUMINIO MATE  
CHROME OR MAT ALUMINIO HANDLE  
POIGNÉE CHROME OU NICKEL



### VITREO

MARCO ALUMINIO ANONIZADO BLACK  
BLACK ANODIZED ALUMINUM FRAME  
CADRE EN ALUMINIUM ANODISÉ NOIR  
CRISTAL PARSOL  
PARSOL GLASS | VERRE PARSOL

## PUERTAS CORREDERAS

SLIDING DOORS | PORTES COULISSANTES



### DELTA

CHAPA  
VENEER | BOIS  
LACA MATE  
MAT LACQUERED | LAQUE MATE



### TANIA

CHAPA  
VENEER | BOIS  
LACA MATE  
MAT LACQUERED | LAQUE MATE



### PIXEL

CHAPA  
VENEER | BOIS  
LACA MATE  
MAT LACQUERED | LAQUE MATE



### DRACO C

CHAPA  
VENEER | BOIS  
LACA MATE  
MAT LACQUERED | LAQUE MATE

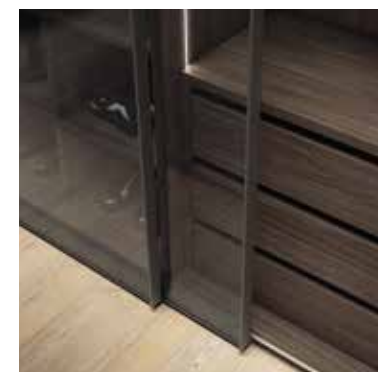

### DOBLE

MARCO ALUMINIO LACADO  
LACQUERED ALUMINUM FRAME  
CADRE LAQUÉ ALUMINIUM  
CRISTAL  
GLASS | VERRE

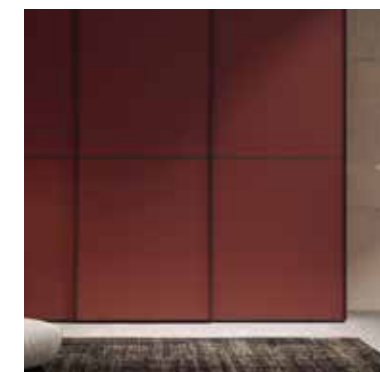

### DOBLE

MARCO ALUMINIO LACADO  
LACQUERED ALUMINUM FRAME  
CADRE LAQUÉ ALUMINIUM  
LACA MATE  
MAT LACQUERED | LAQUE MATE  
CHAPA  
VENEER / BOIS

## PUERTAS PLEGABLES

FOLDING DOORS | PORTES PLIANTES



### NORMA

LACA MATE, CHAPA,  
TIRADOR MARRÓN METAL O LACADO  
MAT LACQUERED, VENEER  
MARRÓN METAL OR LACQUERED HANDLE  
LAQUE MATE, BOIS  
POIGNÉE MARRÓN METAL OU LAQUÉE

### ONA

LACA MATE, CHAPA,  
TIRADOR MARRÓN METAL O LACADO  
MAT LACQUERED, VENEER  
MARRÓN METAL OR LACQUERED HANDLE  
LAQUE MATE, BOIS  
POIGNÉE MARRÓN METAL OU LAQUÉE

### SCULTOR

LACA MATE  
TIRADOR MARRÓN METAL O LACADO  
MAT LACQUERED,  
MARRÓN METAL OR LACQUERED HANDLE  
LAQUE MATE,  
POIGNÉE MARRÓN METAL OU LAQUÉE

### BODE

LACA MATE, CHAPA  
MAT LACQUERED, VENEER  
LAQUE MATE, BOIS



REALLY | VESTIDORES  
DRESSING ROOMS | DRESSING



REALLY 100 P. 8

L482,2



REALLY 101 P. 13

L362,6



REALLY 102 P. 15

L482,2



REALLY 103 P. 19

L482,2

LINE | BATIENTES  
SWING DOORS | PORTES BATTANTES



HALF 200 P. 22

L359,6



HALF 201 P. 25

L240



TRAMA 202 P. 26

L299,9



NORMA 203 P. 30

L240



NORMA 204 P. 31

L359,6



SCULTOR 205 P. 32

L359,6



SCULTOR | LYRA 206 P. 35

L239,2



VEGA 207 P. 36

L240



CARINA 208 P. 37

L299,9



VEGA 209 P. 38

L359,6



BODE 210 P. 42

L240



DRACO 211 P. 46

L480



LINE | BATIENES

SWING DOORS | PORTES BATTANTES



LEO 212 P. 50 L299,9



ARA 213 P. 54 L240



VITREO 214 P. 58 L359,2

GRUPPO  
muebles  
**INTERMOBEL**

DINAMIC | SINGULARES

SINGULAR WARDROBE | ARMOIRES UNIQUES



SINGULAR 300 P. 64 L240



SINGULAR 301 P. 66 L358,4



SINGULAR 302 P. 68 L599,7



SINGULAR 303 P. 70 L420



SINGULAR 304 P. 72 L360



SINGULAR 305 P. 74 L300



SINGULAR 306 P. 75 L180



SINGULAR 307 P. 74 L237,1+294,4



SINGULAR 308 P. 78 L223,4+237,4



SINGULAR 309 P. 80 L359,6



**MOVIE | CORREDERAS**  
SLIDING WARDROBE | PORTES COULISSANTES



DELTA 400 P. 84

L299,9



TANIA 401 P. 88

L240



PIXEL 402 P. 92

L359,9



DRACO C 403 P. 96

L400



DOBLE 404 P. 100

L299,9



DOBLE 405 P. 103

L299,9



DOBLE 406 P. 104

L360



TS 407 P. 106

L300



TS 408 P. 108

L240

GRUP  
INTERMOBEL



**ACABADOS CHAPA**  
VENEER FINISHES | FINITION BOIS



ROBLE



NOGAL AMERICANO



OAK NUDOS

**ACABADOS TRASERAS**  
REAR FINISHES | FINITIONS ARRIÈRE



FLORAL

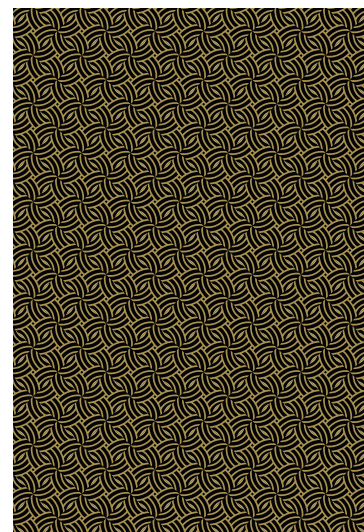

DORADA



BEIGE



OREGÓN

**ACABADOS LACA**  
LACQUERED FINISHES | FINITIONS LAQUE

Las lacas están disponibles en acabado mate.  
Lacquers are available in a matte finish | Les laques sont disponibles dans une finition mate

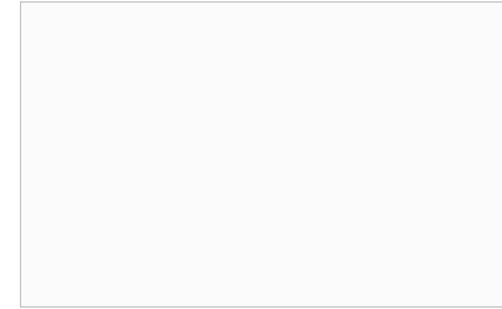

BLANCO



NEGRUZCO



SOMBRA



PERLA

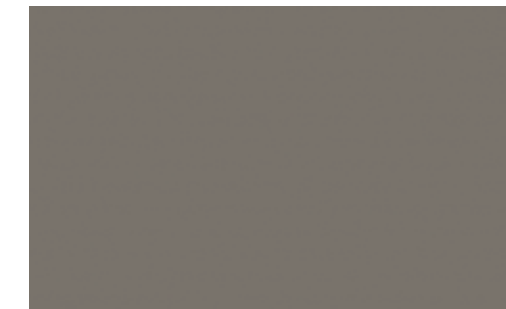

TIZA



BLUE

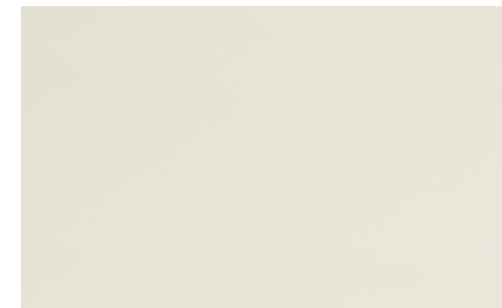

SEPIA



ALMENDRA



TÓRTORA

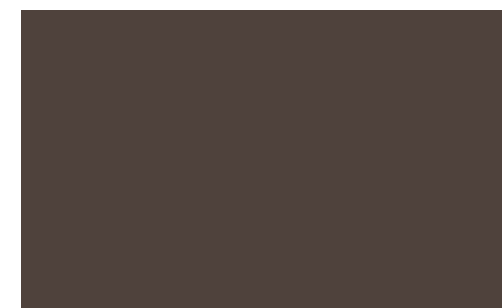

CASTAÑO



BAMBÚ



MOSTAZA



CORAL



TEJA "NEW"



SALVIA



# mesegue®

MUEBLES MESEGUE, S.A.

CTRA. SANTA BÁRBARA, KM. 21  
43560 LA SÉNIA (TARRAGONA)  
ESPAÑA

Tel. +34 977 713 188  
Fax.+34 977 575 381  
mesegue@mesegue.com  
www.mesegue.com

Diseño de producto  
Product design | Design du produit

Muebles Mesegue  
Irene Vaquer - Triloby Estudio

Concepto gráfico  
Graphic Artworks | Concepte graphique

Irene Vaquer

Fotografía  
Photography | Photographie

3Estudi

Fotomecánica / Impresión  
Photo / Press | Photomécanique / Impression

Pentagraf Impresores

# m

GRUPO  
**INTERMOBEL**

MUEBLES MESEGUE se reserva el derecho de introducir las modificaciones que considere necesarias en beneficio del producto y del cliente. Debido a los procesos de impresión, los colores que aparecen en este catálogo deben de considerarse aproximados. El contenido de este catálogo, está protegido, en su totalidad por copyright. Queda prohibida la reproducción total o parcial de imágenes y conceptos gráficos, sin la autorización de MUEBLES MESEGUE.

MUEBLES MESEGUE reserves the right to make changes it deems necessary for the benefit of the product and the customer. Due to printing processes, colors displayed in this catalog should be considered approximate. The contents of this catalog are protected by copyright. The total or partial reproduction of images and graphic concepts is prohibited, without the authorization of MUEBLES MESEGUE.

MUEBLES MESEGUE se réserve le droit d'introduire les modifications qu'elle considère nécessaires au bénéfice du produit et du client. Dû au processus de l'impression, les couleurs qui apparaissent dans ce catalogue doivent se considérer approximatives. Le contenu de ce catalogue est protégé dans sa totalité par Copyright. La reproduction totale ou partielle des images et concepts graphiques est totalement interdite sans l'autorisation de MUEBLES MESEGUE.



m

GRUPO  
INTERMOBEL

mesegue®  
[www.mesegue.com](http://www.mesegue.com)